

Tasleem Pura Road Ugoki
Sialkot 51310- Pakistan.
Phone : 0092-52-351-0585
Fax : 0092-52-351-0585
info@mediworldsurgical.com
www.mediworldsurgical.com

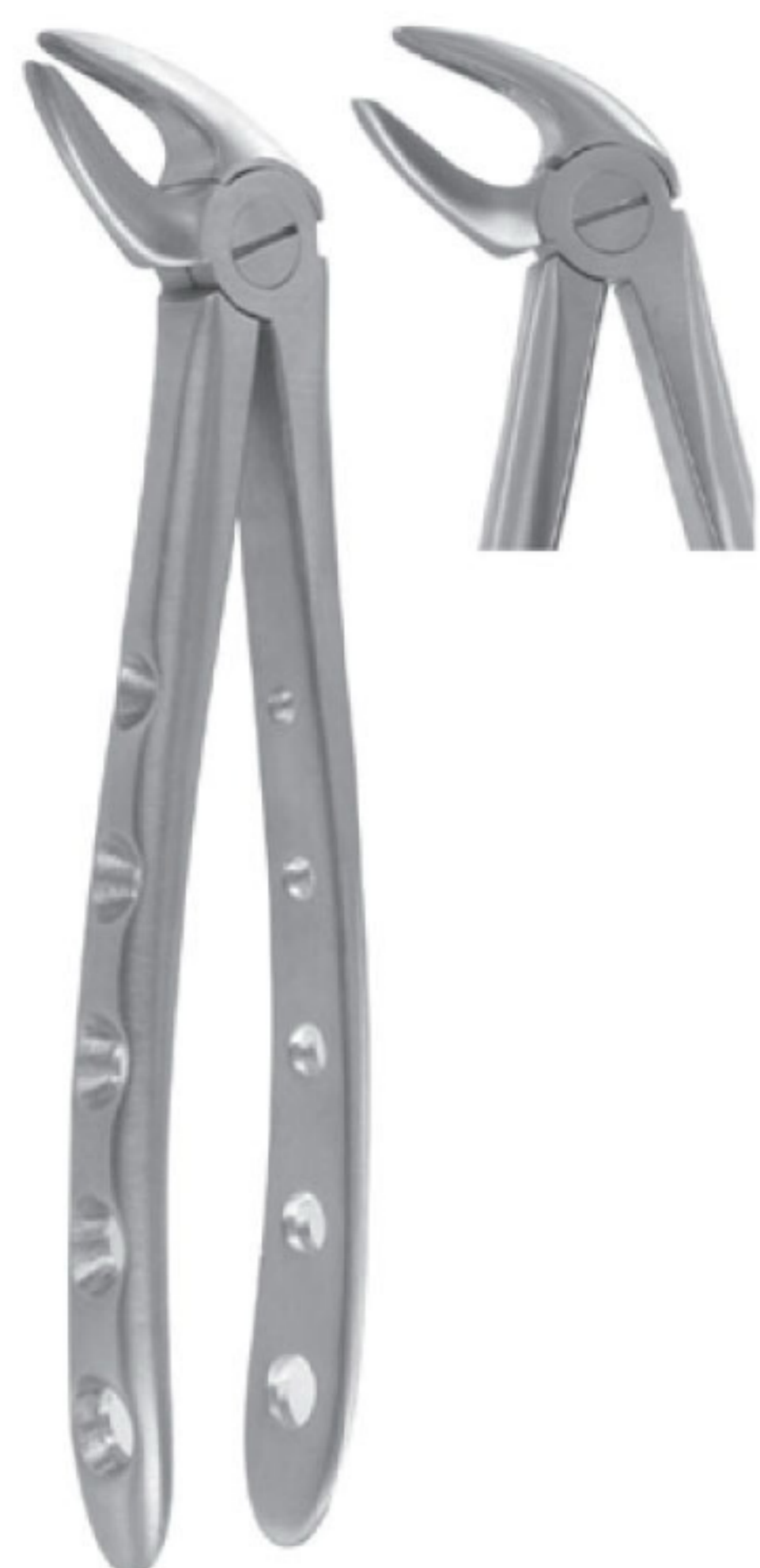

**Extracting Forcep
MWD-1001**
Fig.4, Lower Incisor



**Fig. 8, Lower Premolars
MWD-1002**
Fig. 8, Lower Premolars



**Fig.1 Upper Centrals & Canines
MWD-1003**
Fig.1 Upper Centrals & Canines

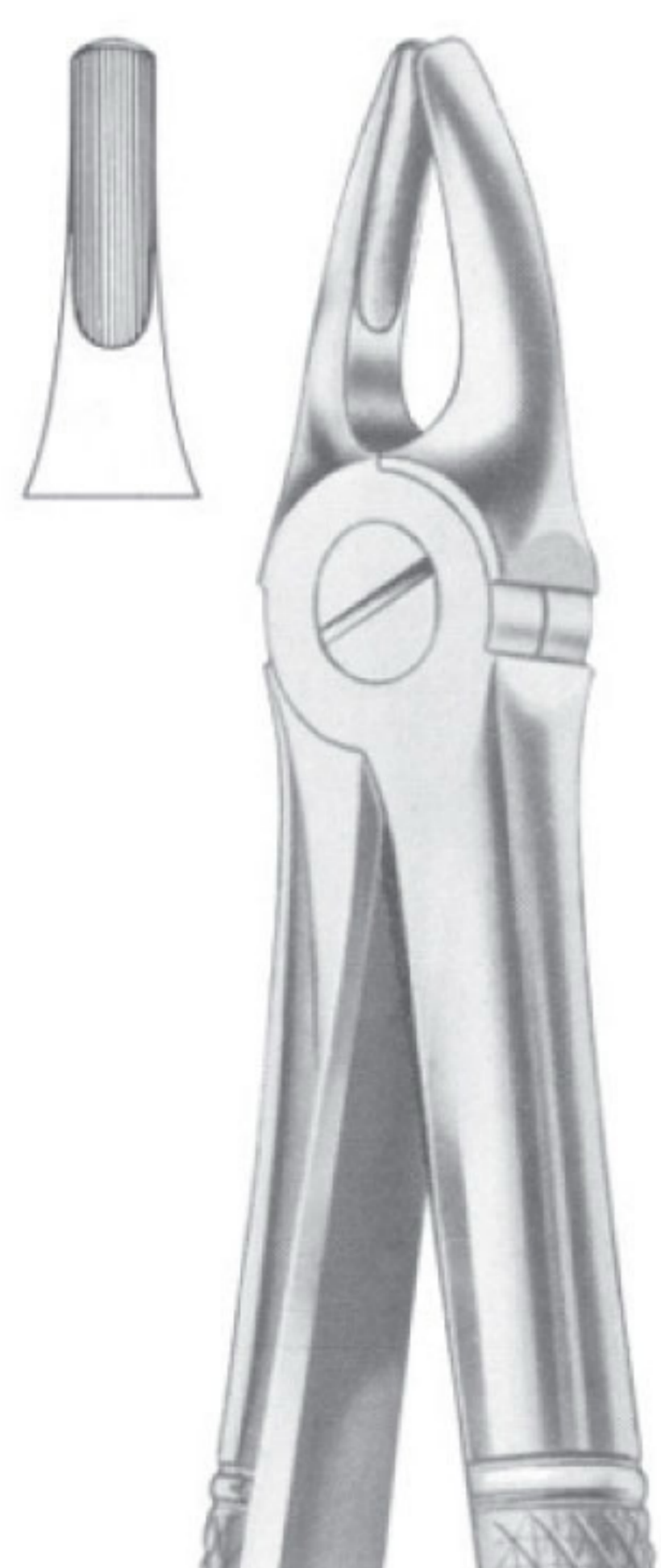

**Fig.2 Upper Laterals & Canines
MWD-1004**
Fig.2 Upper Laterals & Canines



**Fig. 3 upper incisors & canines
MWD-1005**
Fig. 3 upper incisors & canines



**Fig. 4 upper incisors & canines
MWD-1006**
Fig. 4 upper incisors & canines

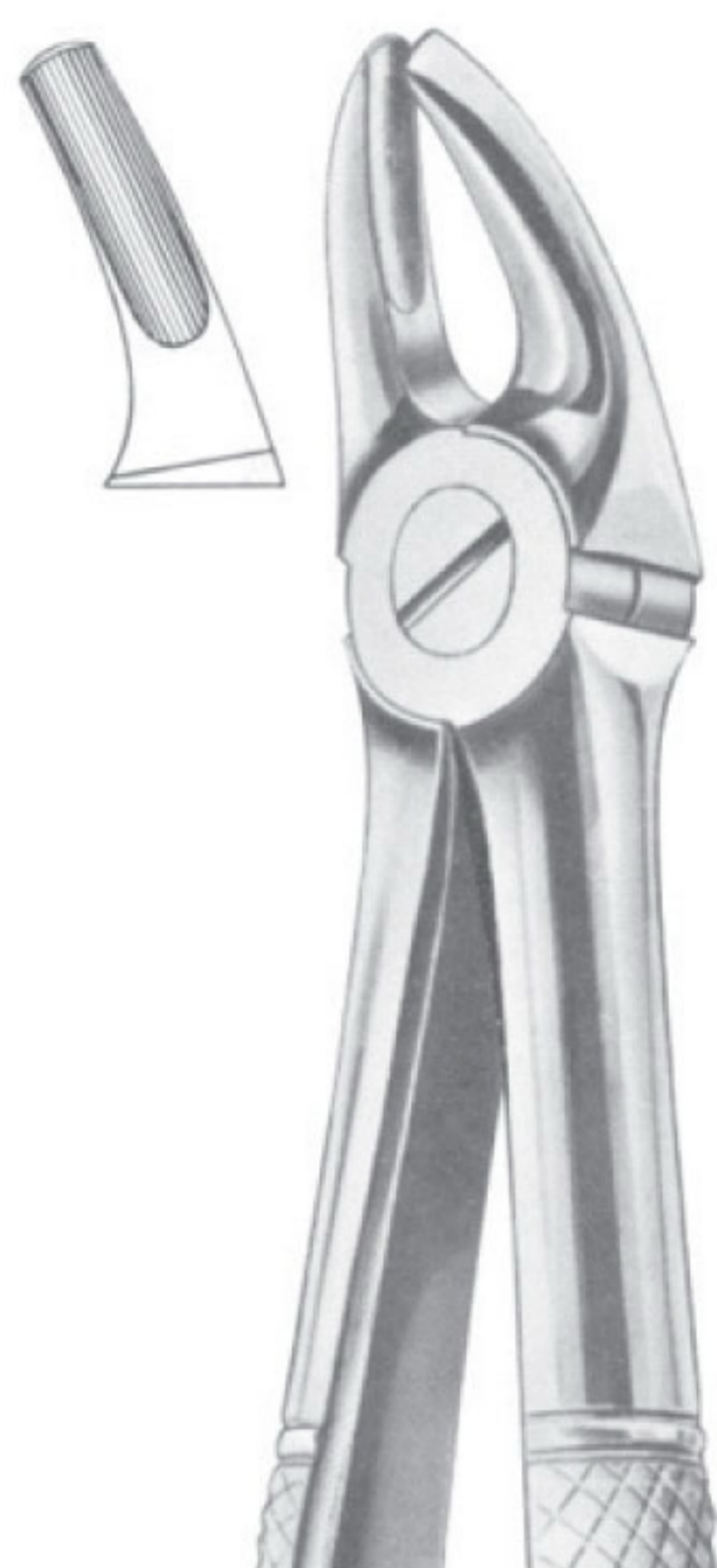

Fig. 7 upper premolars
MWD-1007
Fig. 7 upper premolars



Fig. 8 lower premolars
MWD-1008
Fig. 8 lower premolars

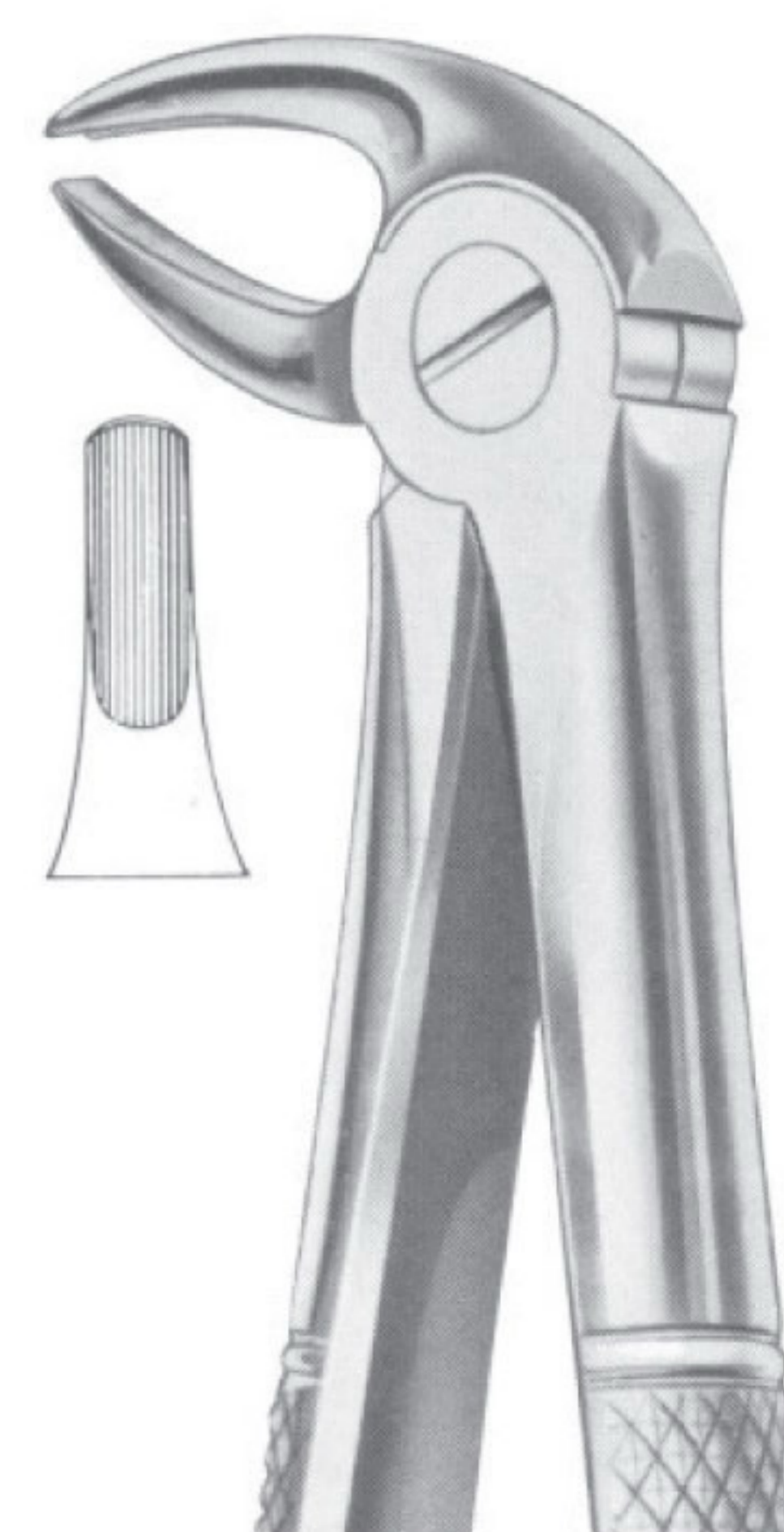

Fig. 13 lower premolars
MWD-1009
Fig. 13 lower premolars



Fig. 13S lower premolars for children.
MWD-1010
Fig. 13S lower premolars for children.



Fig. 17 upper molars, right
MWD-1011
Fig. 17 upper molars, right

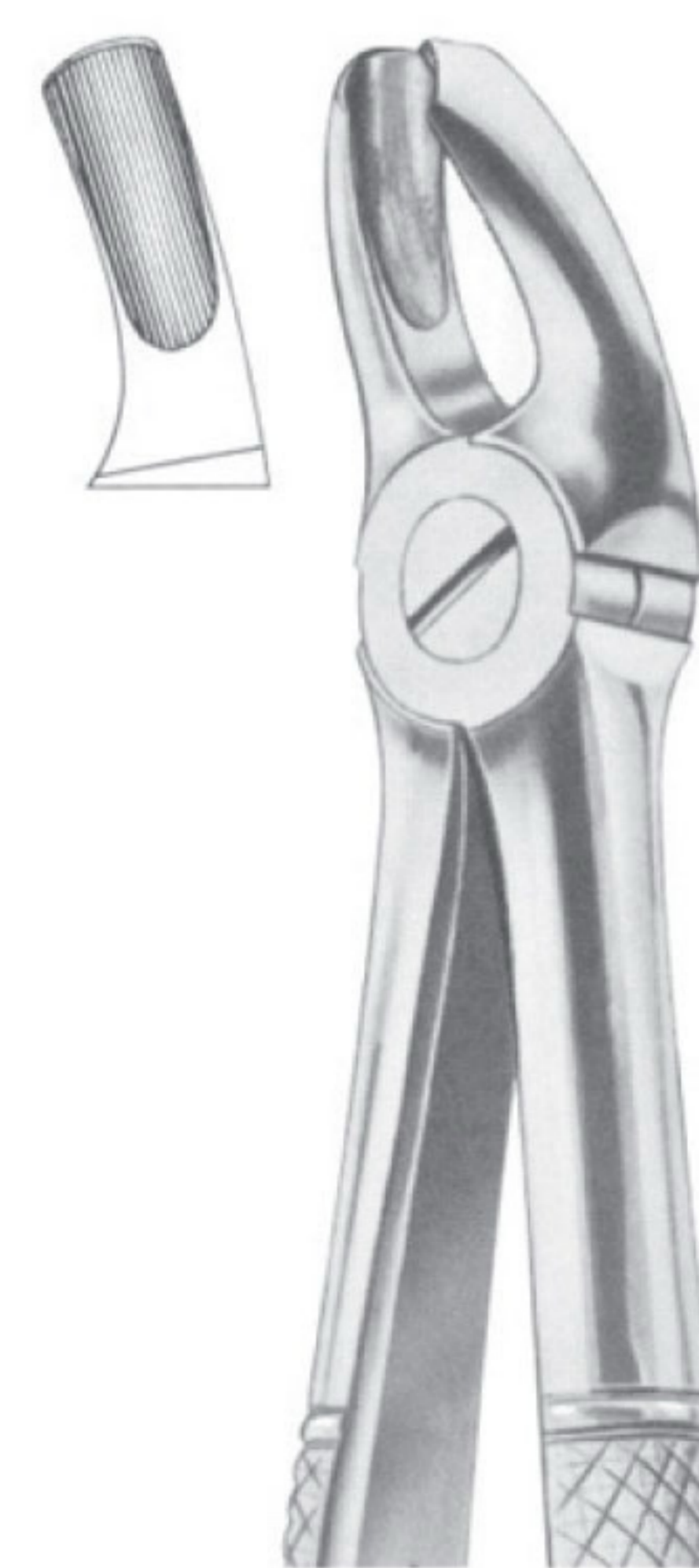

Fig. 18 upper molars, left
MWD-1012
Fig. 18 upper molars, left

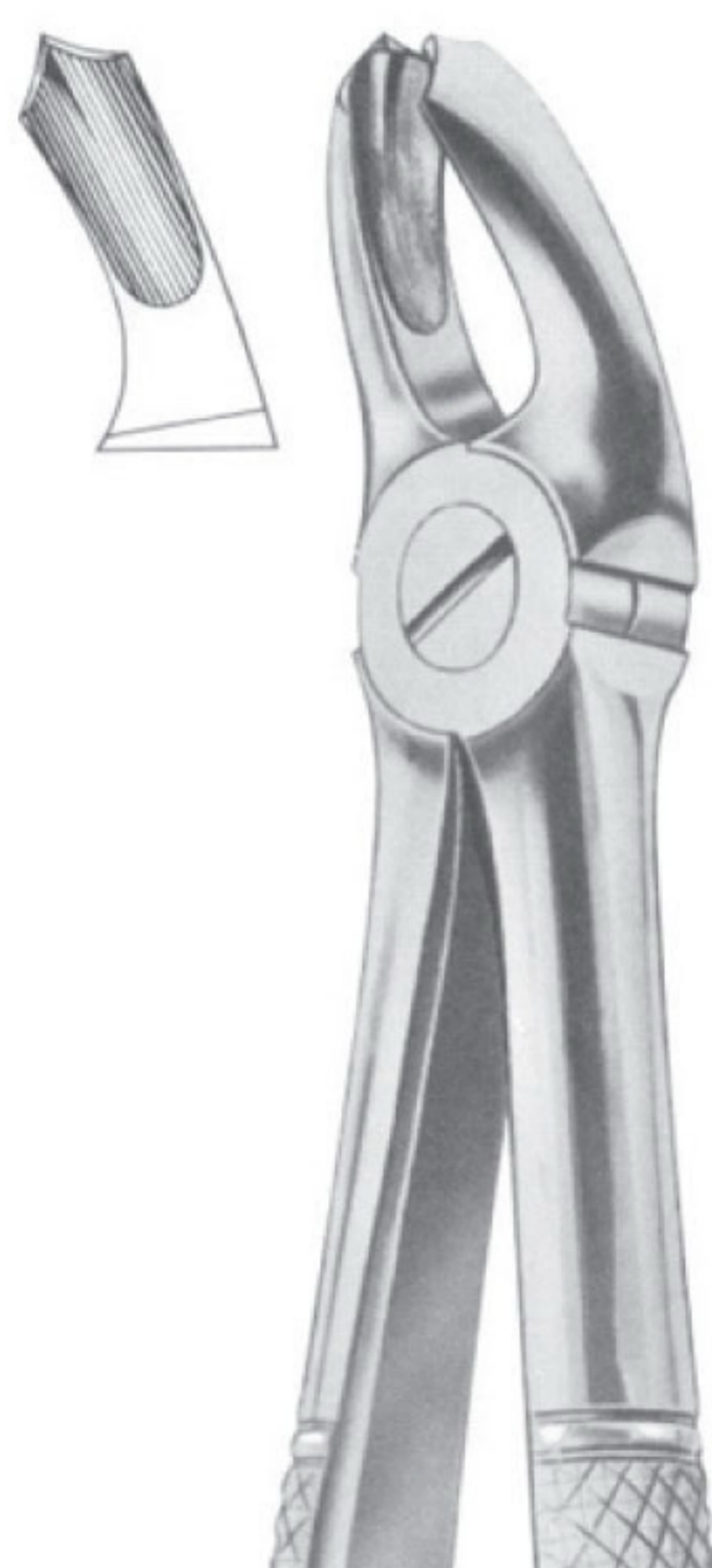

Fig. 18A upper molars
MWD-1013
Fig. 18A upper molars

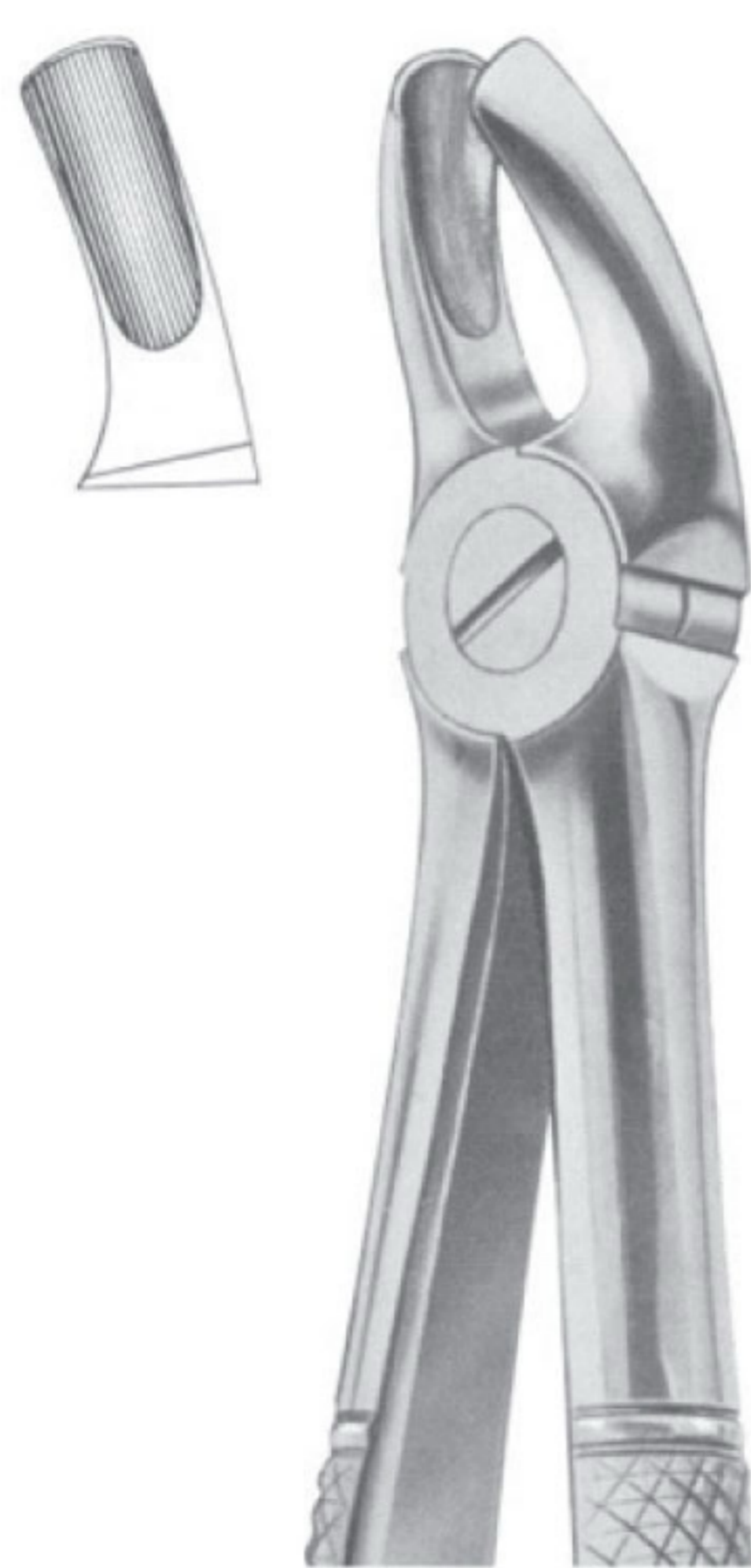

Fig. 18B upper molars
MWD-1014
Fig. 18B upper molars

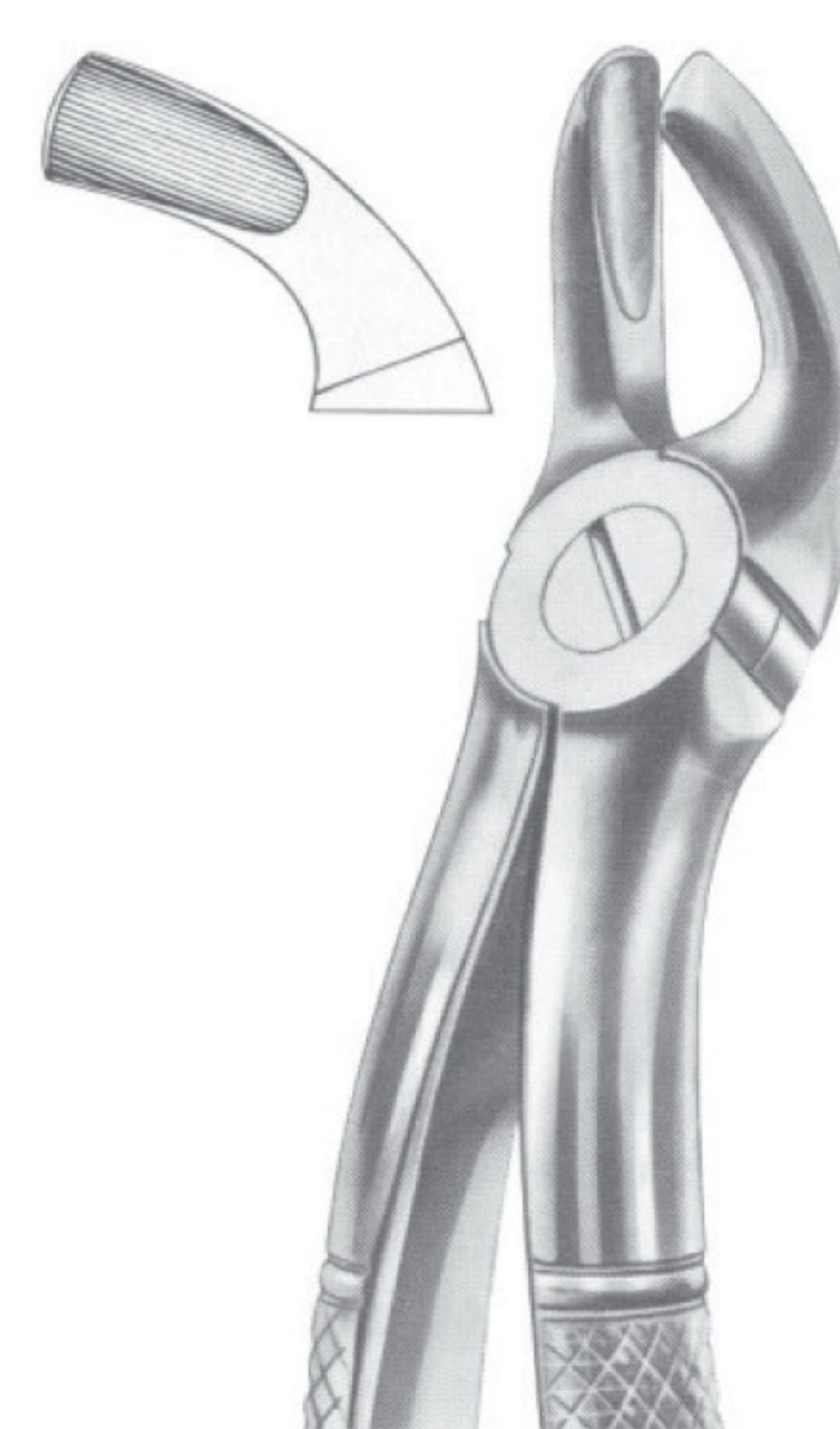

Fig. 19 upper third molars
MWD-1015
Fig. 19 upper third molars



Fig. 20 upper third molars
MWD-1016
Fig. 20 upper third molars

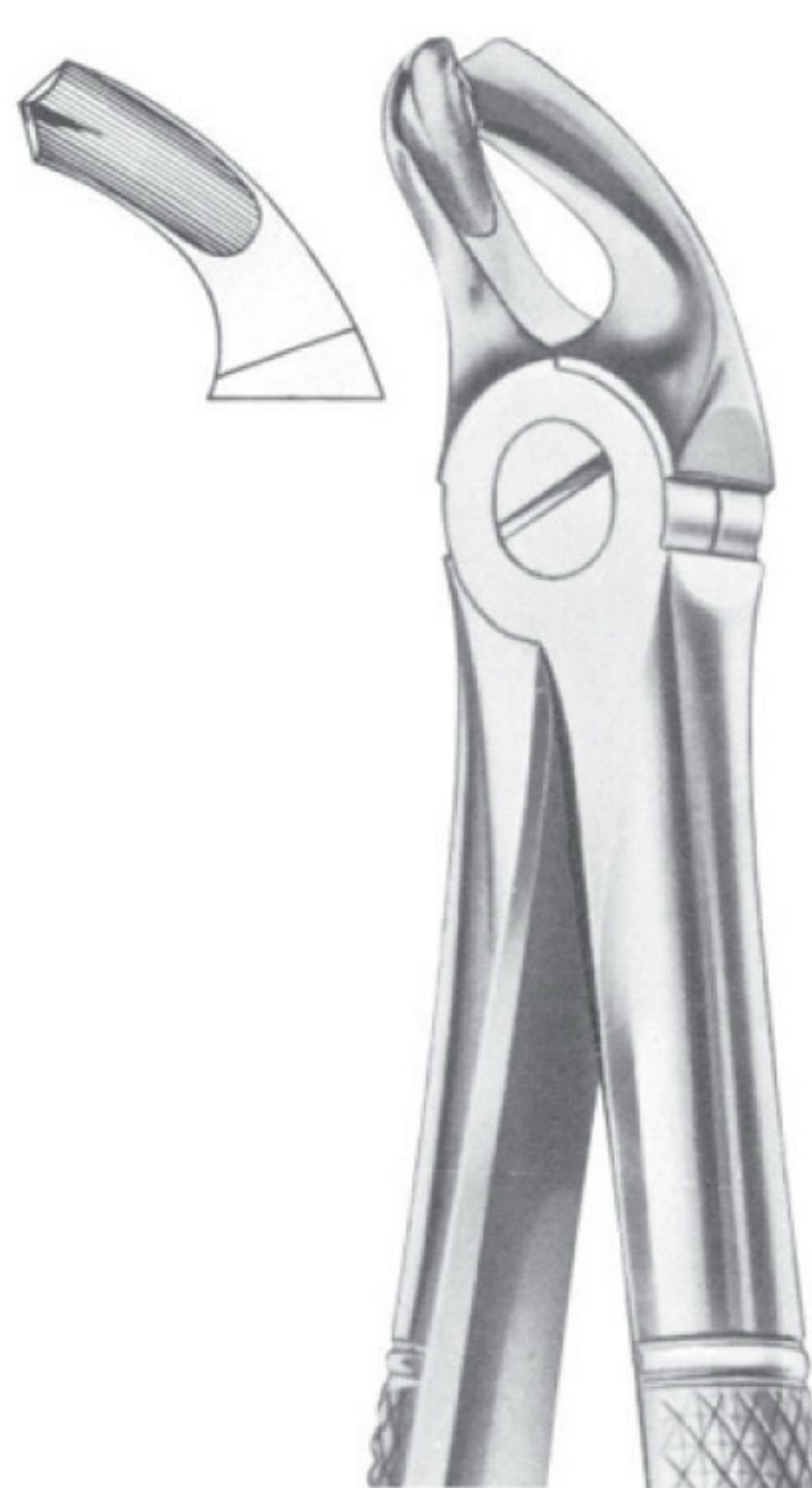

Fig. 21 lower molars
MWD-1017
Fig. 21 lower molars

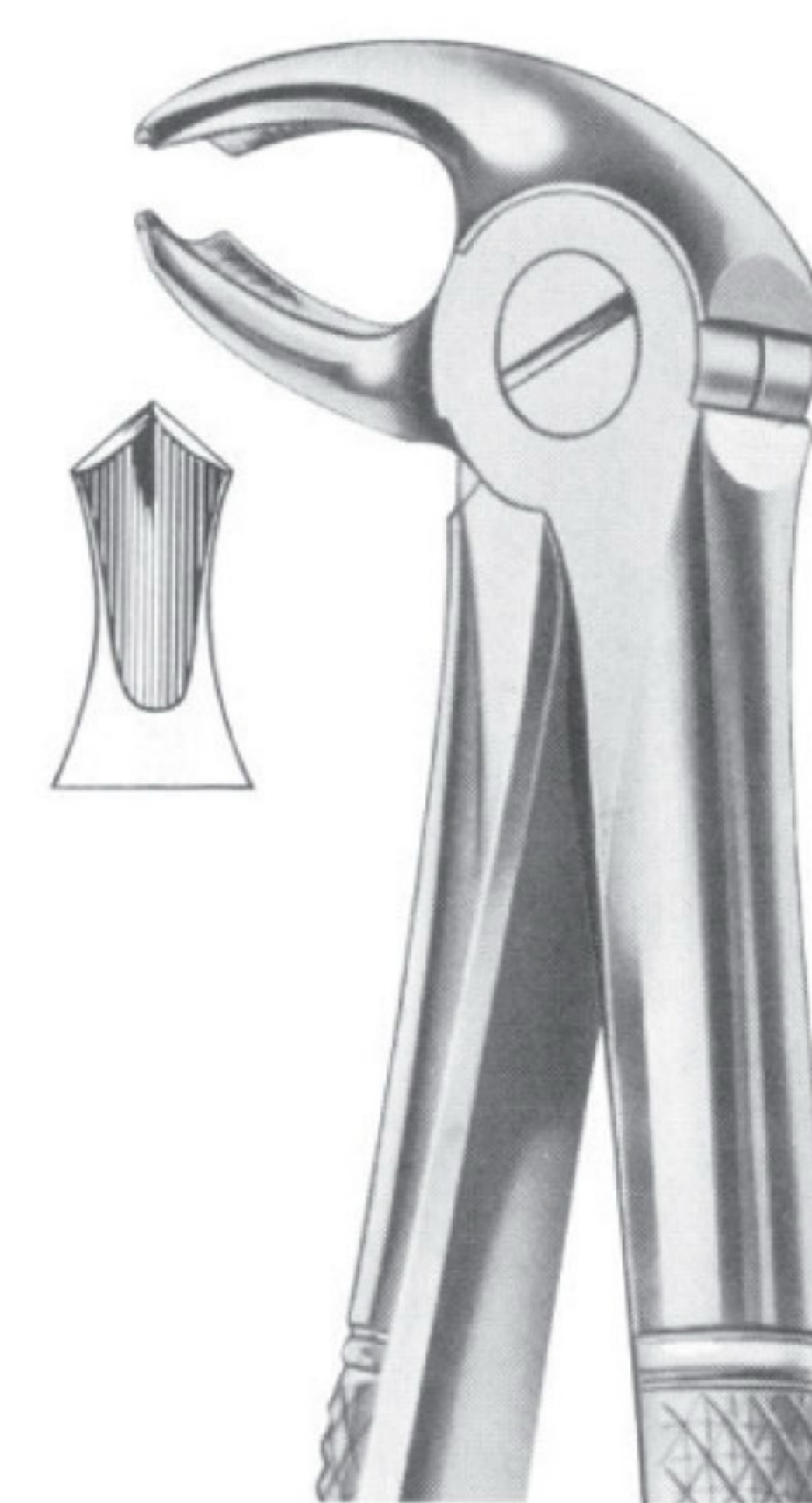

Fig. 22 lower molars
MWD-1018
Fig. 22 lower molars

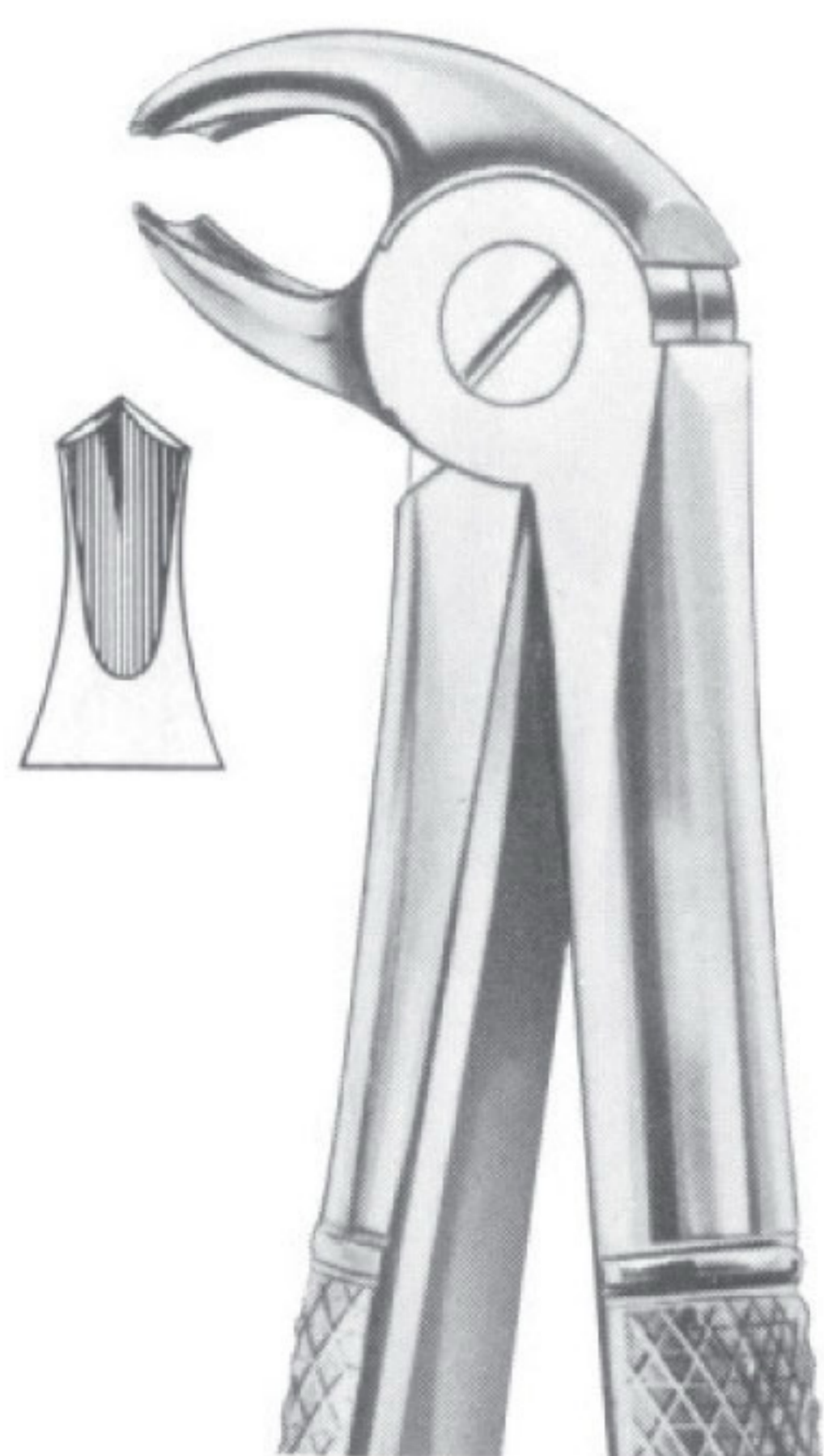

Fig. 22S lower molars for children
MWD-1019
 Fig. 22S lower molars for children

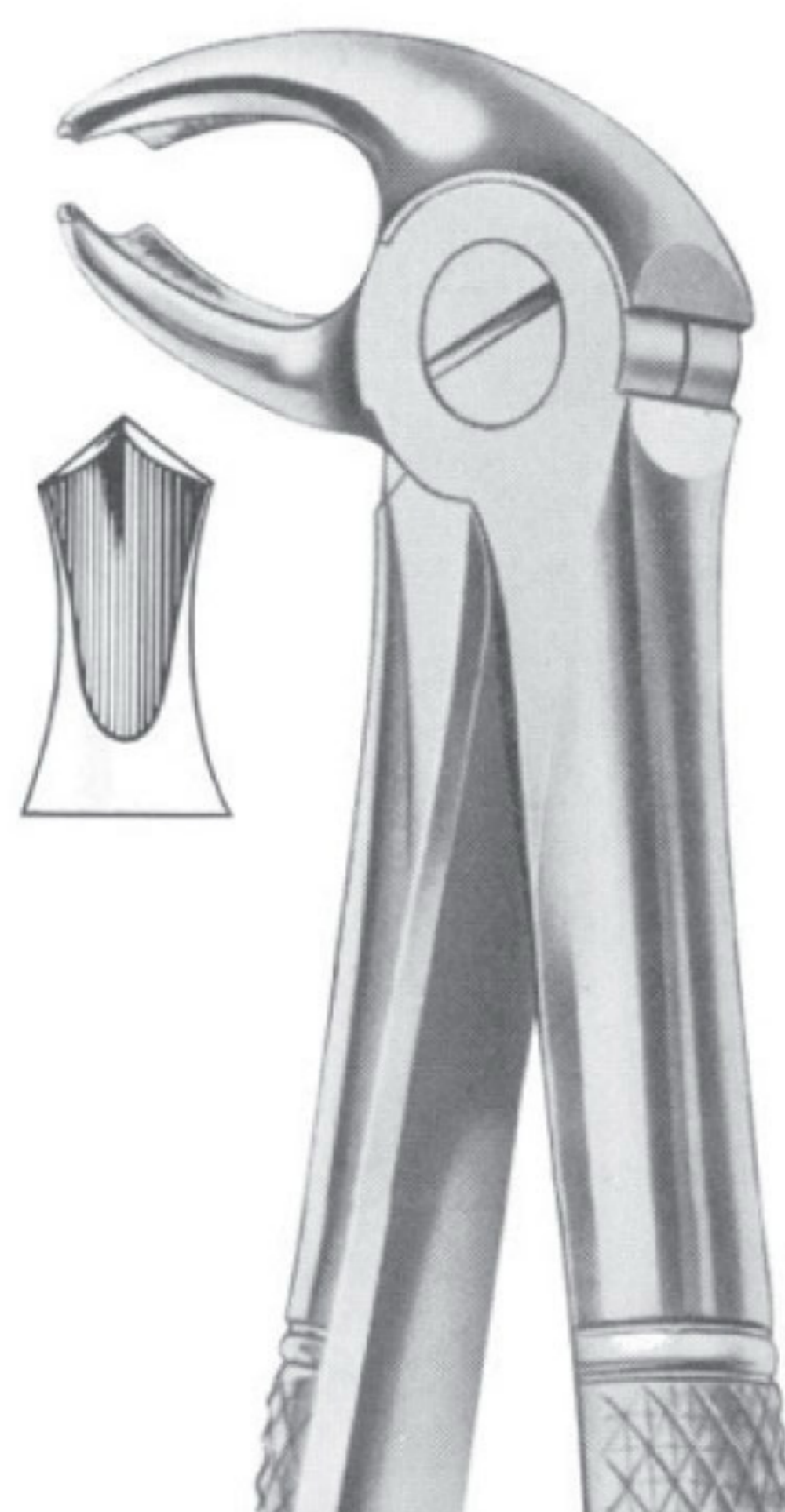

Fig. 22G lower molars
MWD-1020
 Fig. 22G lower molars

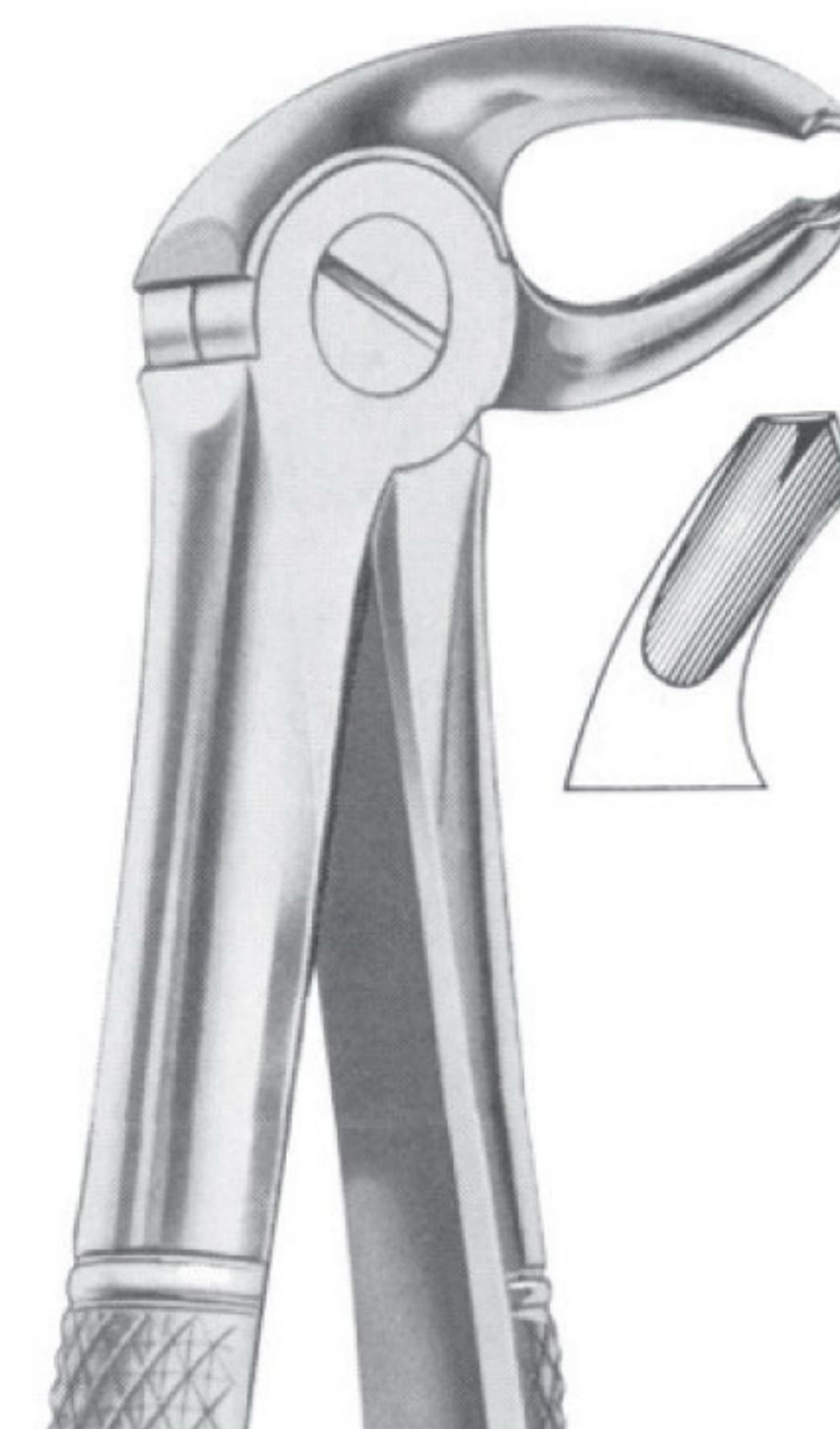

Fig. 23 lower molars right
MWD-1021
 Fig. 23 lower molars right

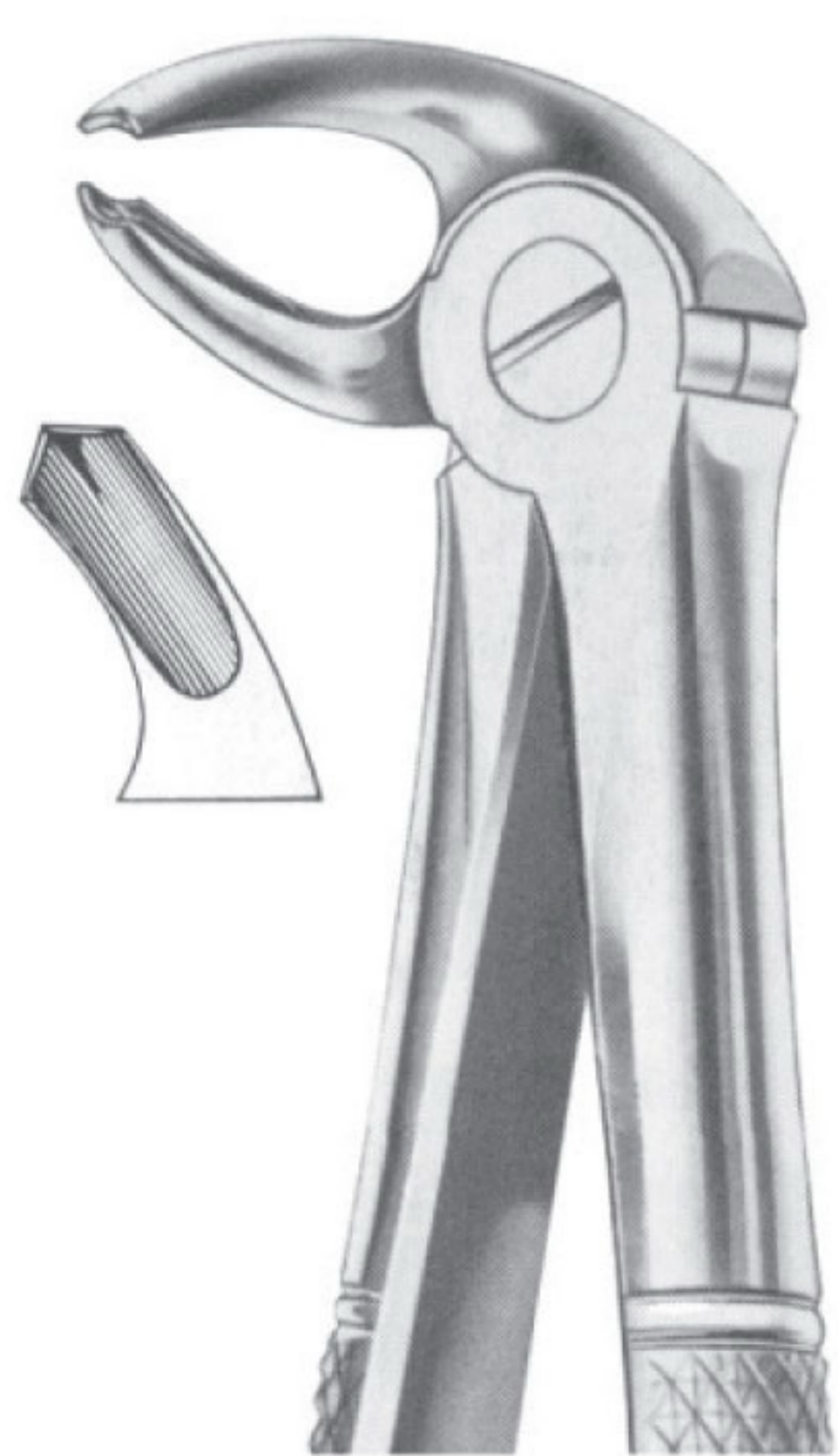

Fig. 24 lower molars left
MWD-1022
 Fig. 24 lower molars left



Fig. 29 upper roots
MWD-1023
 Fig. 29 upper roots

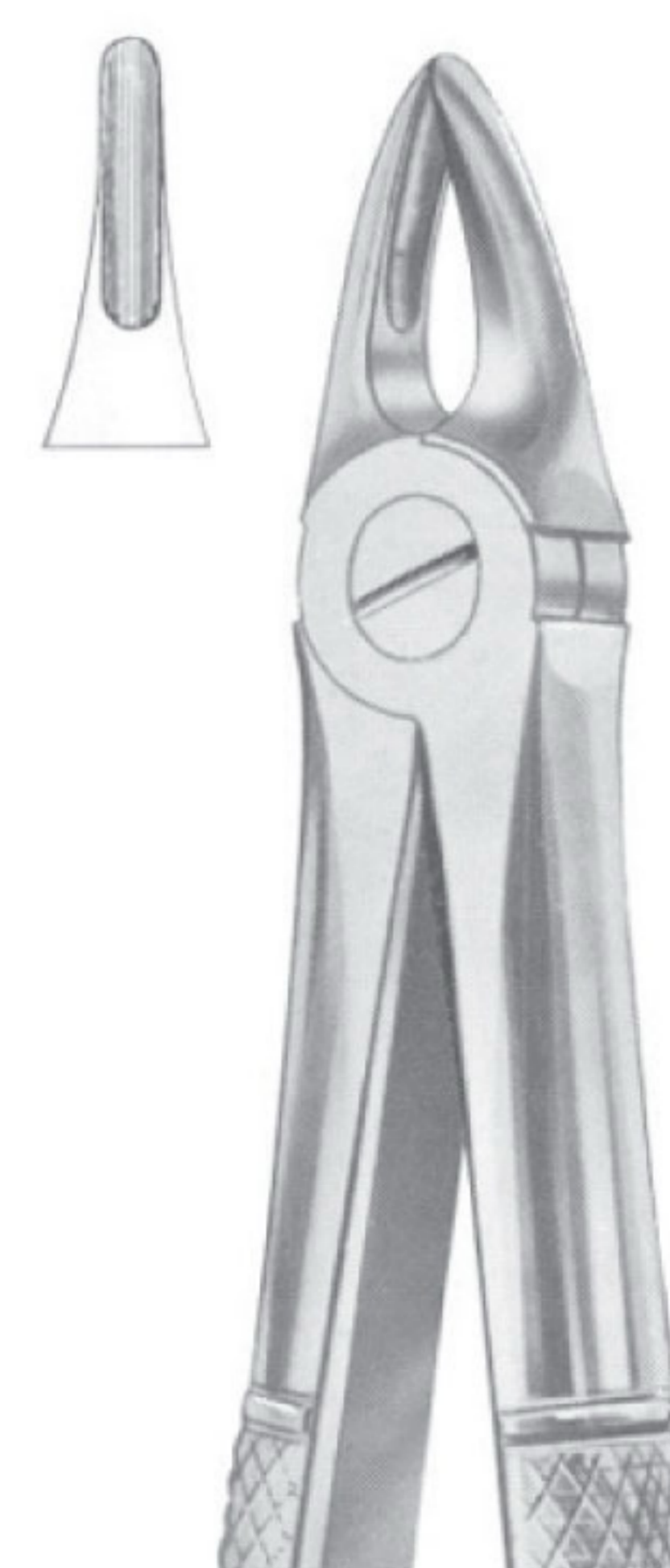

Fig. 29S upper roots for children
MWD-1024
 Fig. 29S upper roots for children

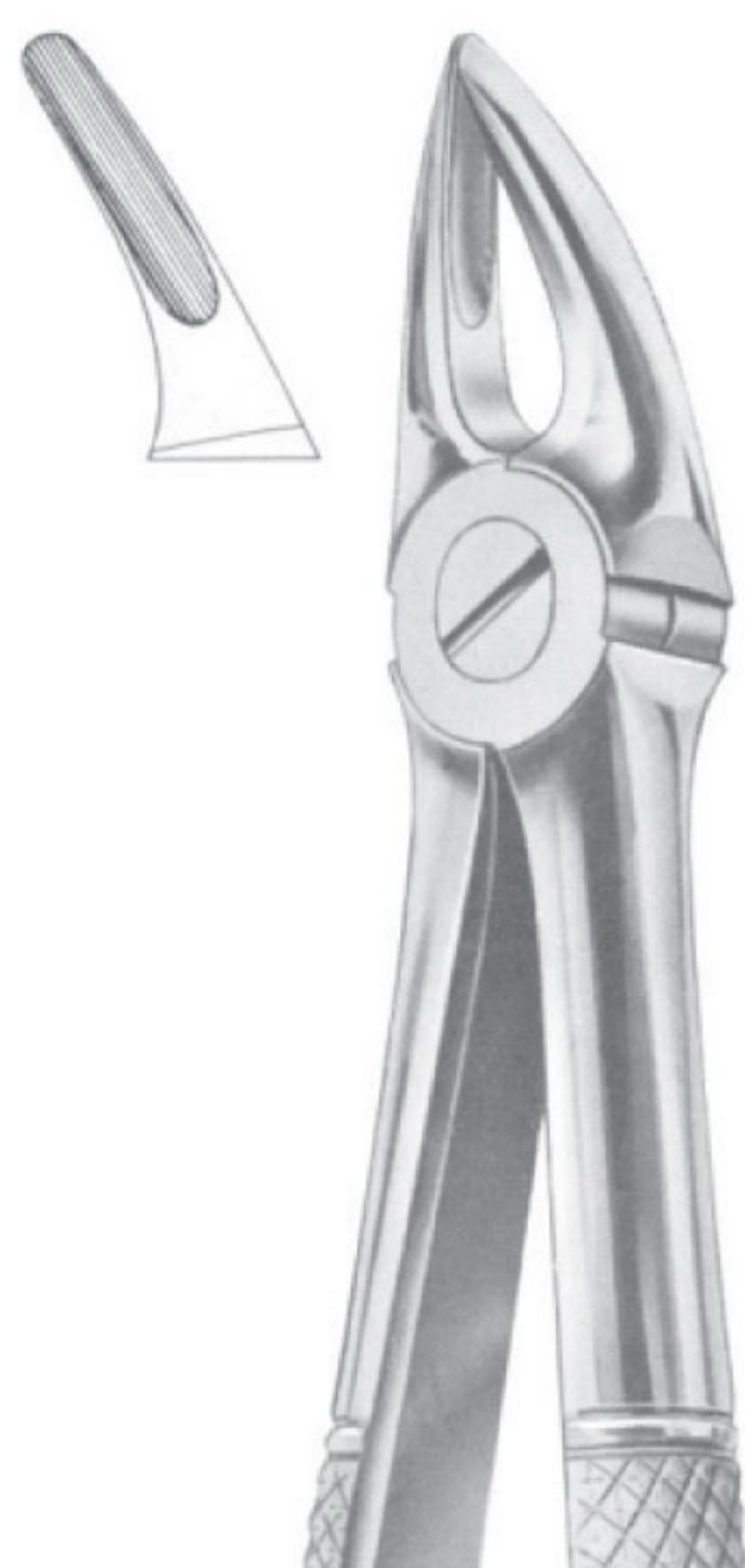

Fig. 30 upper roots
MWD-1025
Fig. 30 upper roots

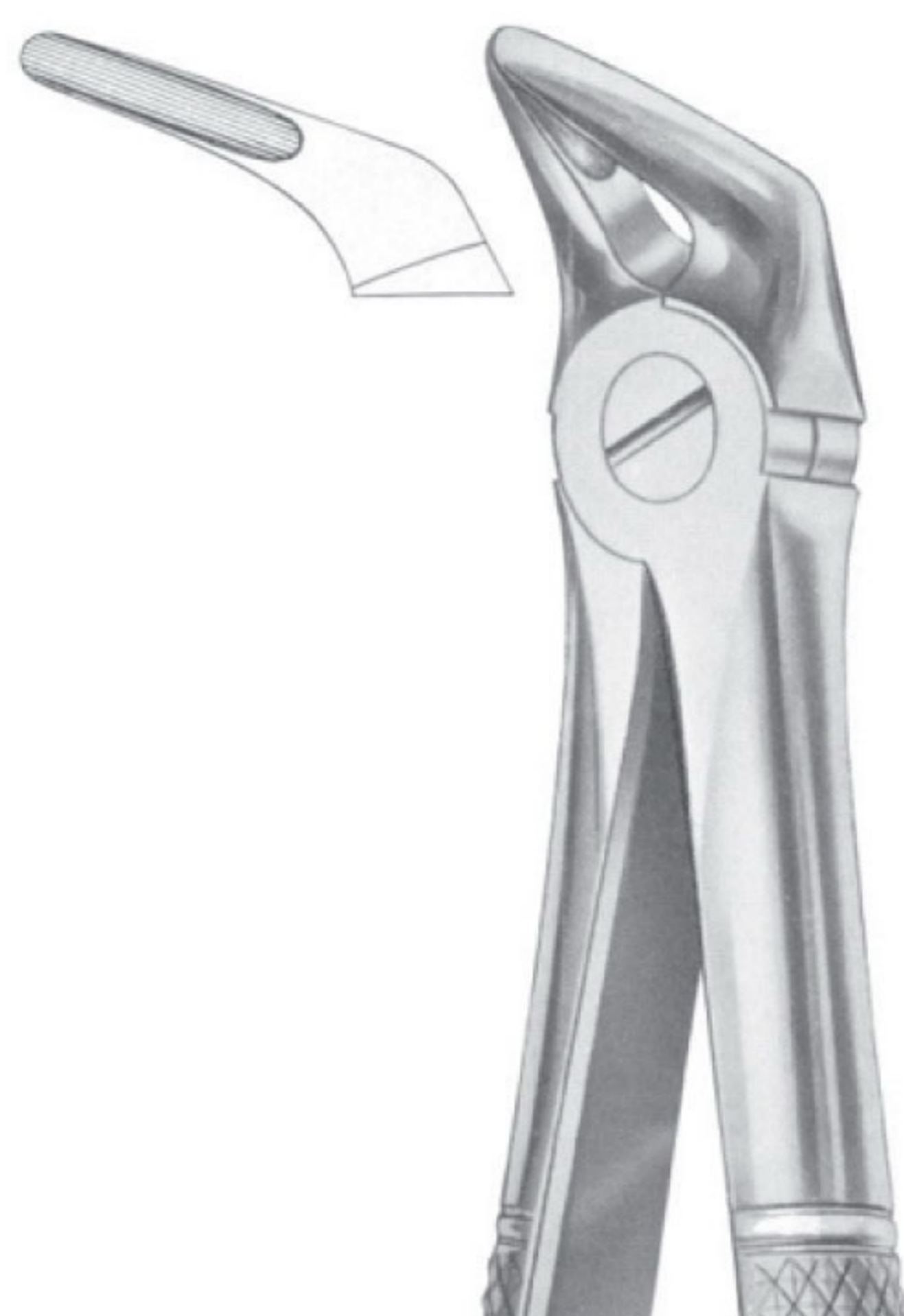

Fig. 31 lower roots
MWD-1026
Fig. 31 lower roots

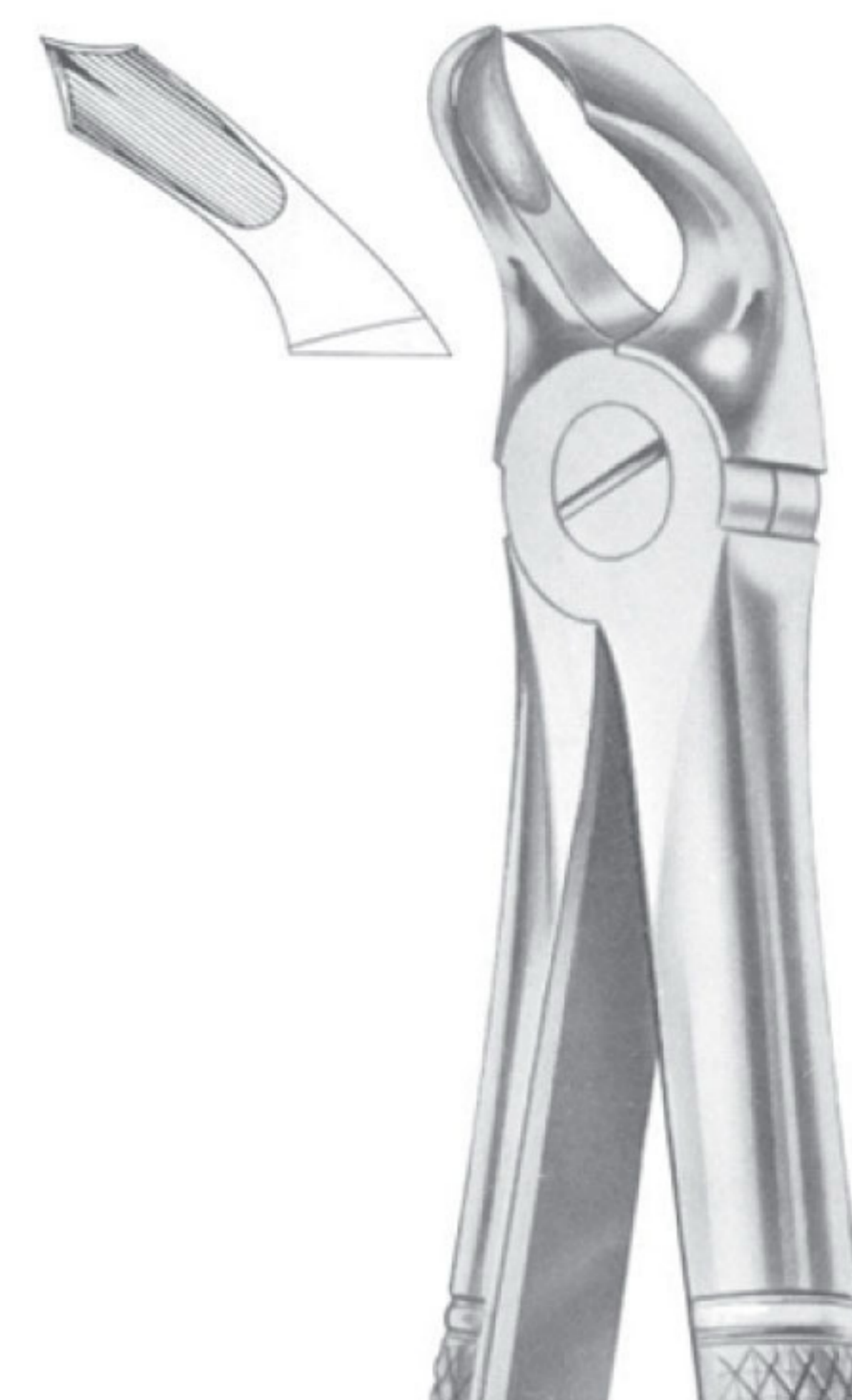

Fig. 32 lower molars
MWD-1027
Fig. 32 lower molars



Fig. 30S upper roots for children
MWD-1028
Fig. 30S upper roots for children



Fig. 33 lower roots
MWD-1029
Fig. 33 lower roots

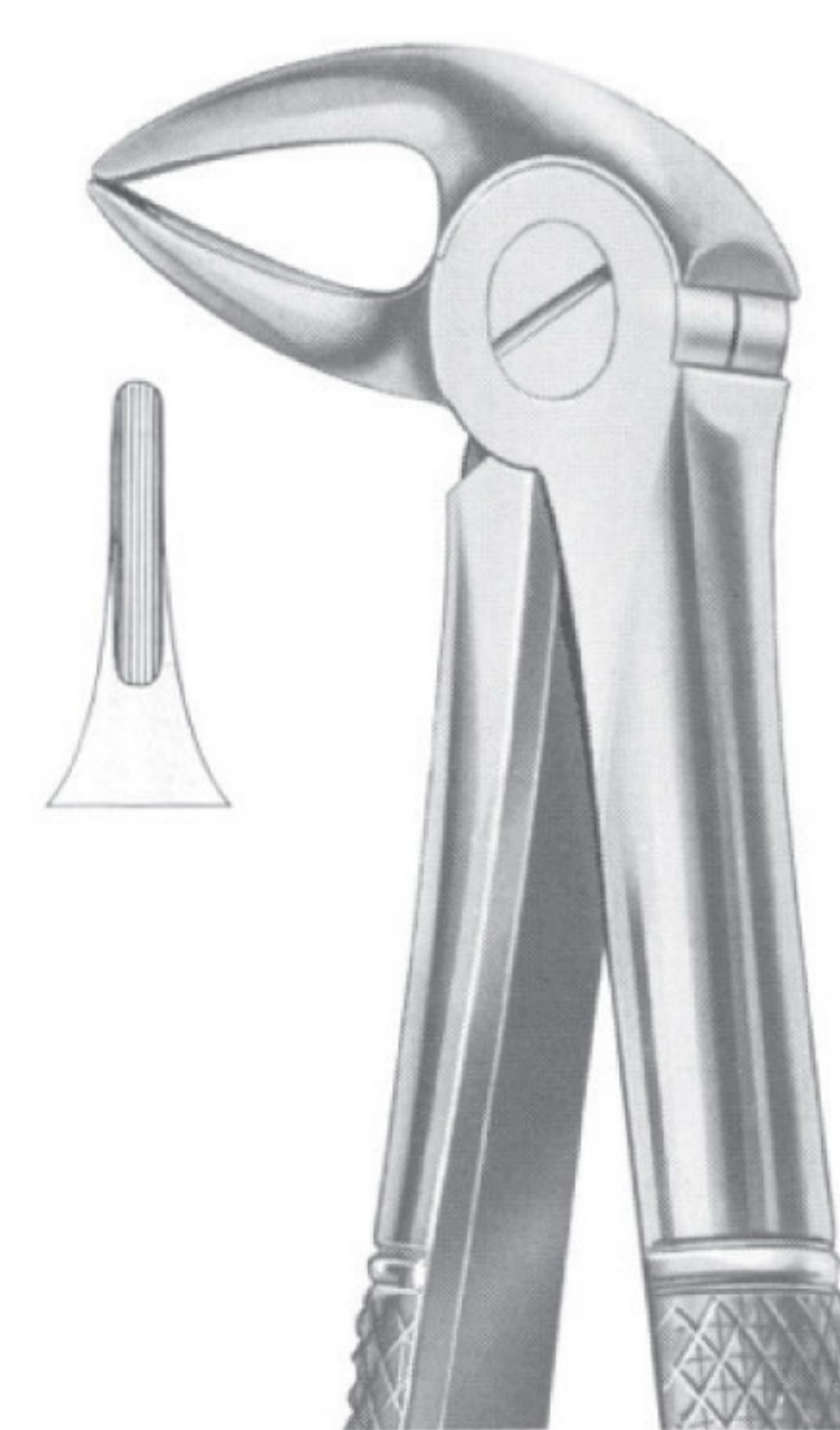

Fig. 33A lower roots
MWD-1030
Fig. 33A lower roots



Fig. 33B lower roots
MWD-1031
Fig. 33B lower roots



Fig. 33L lower roots
MWD-1032
Fig. 33L lower roots



1033 Fig. 37 upper incisors for children
MWD-1033
Fig. 37 upper incisors for children



Fig. 33S lower roots for children
MWD-1034
Fig. 33S lower roots for children



Fig. 38 lower incisors & canines for children
MWD-1035
Fig. 38 lower incisors & canines for children

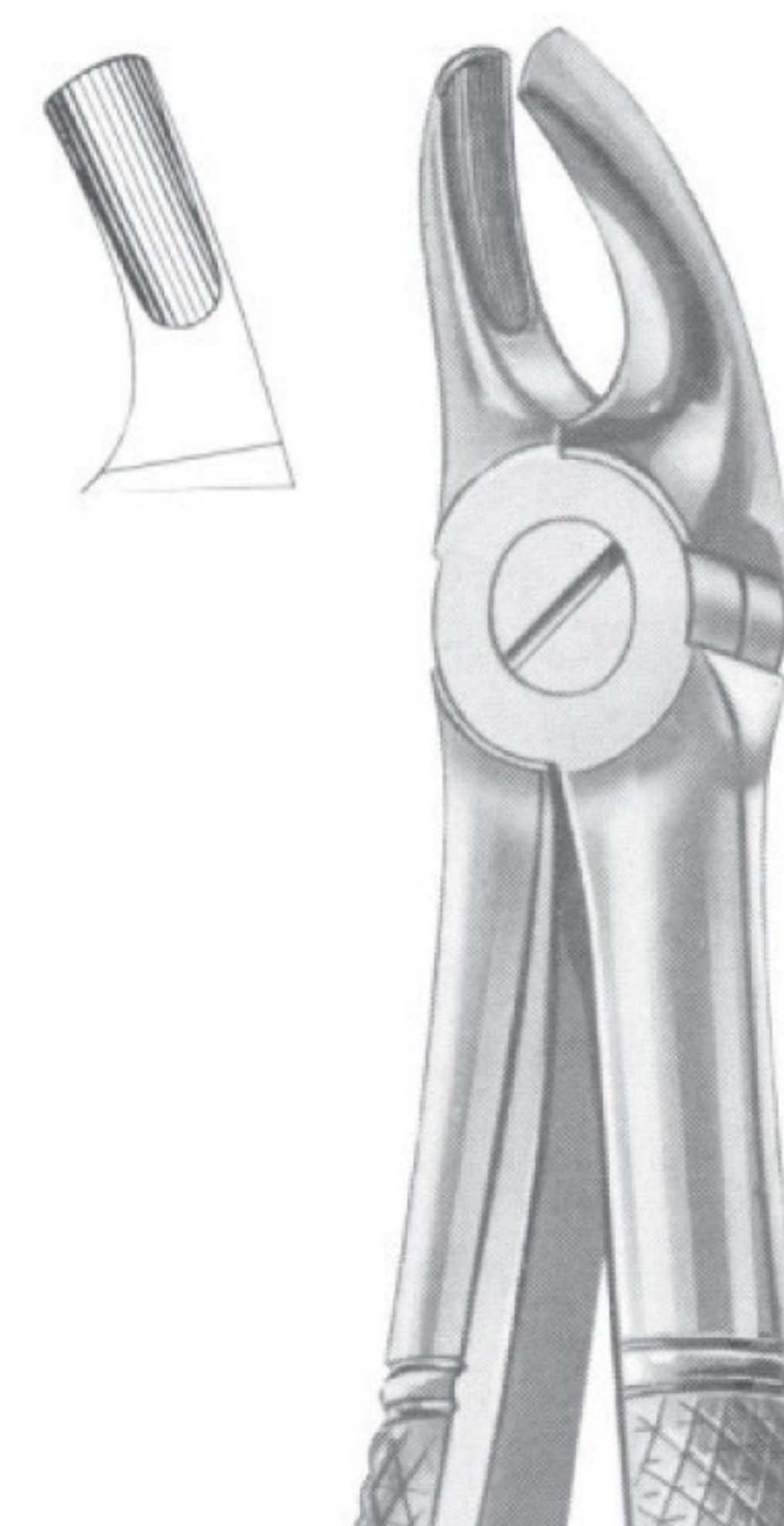
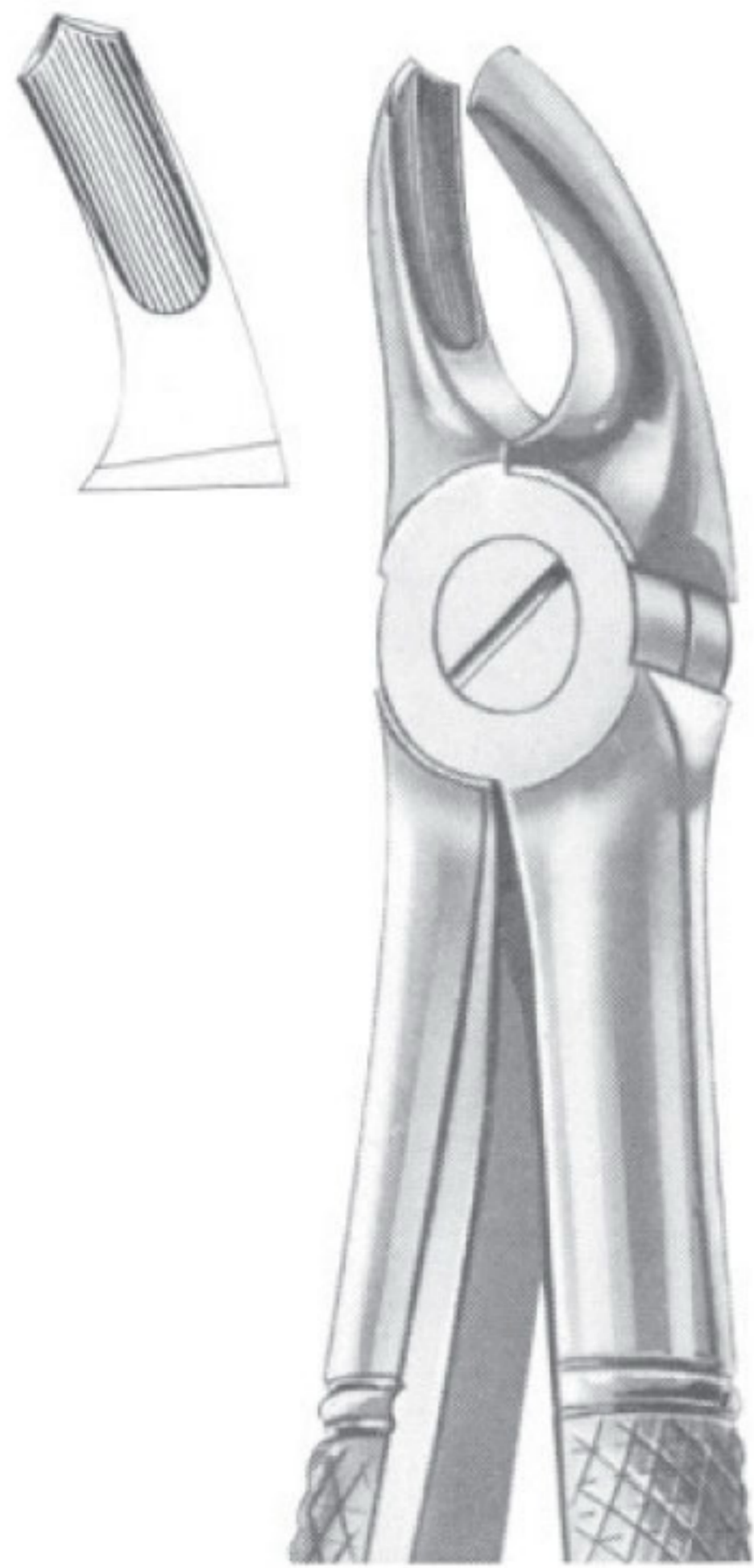
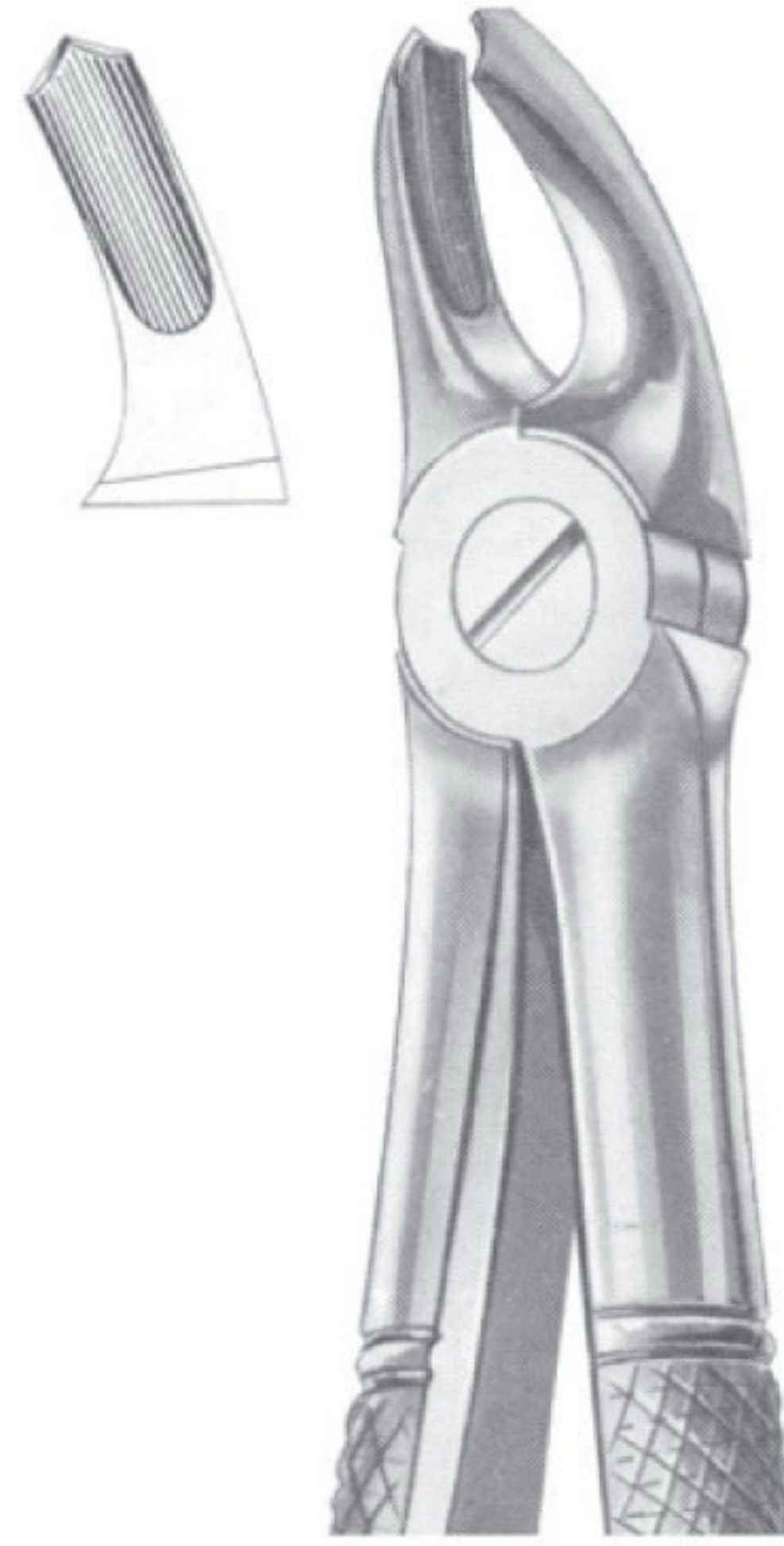

Fig. 39 upper molars for children
MWD-1036
Fig. 39 upper molars for children



**Fig. 39R upper molars right for children
MWD-1037**
Fig. 39R upper molars right for children



**Fig. 39A upper molars for children
MWD-1038**
Fig. 39A upper molars for children



**Fig. 40 lower molars for children
MWD-1039**
Fig. 40 lower molars for children



**Fig. 39L upper molars left for children
MWD-1040**
Fig. 39L upper molars left for children



**Fig. 41 upper roots
MWD-1041**
Fig. 41 upper roots

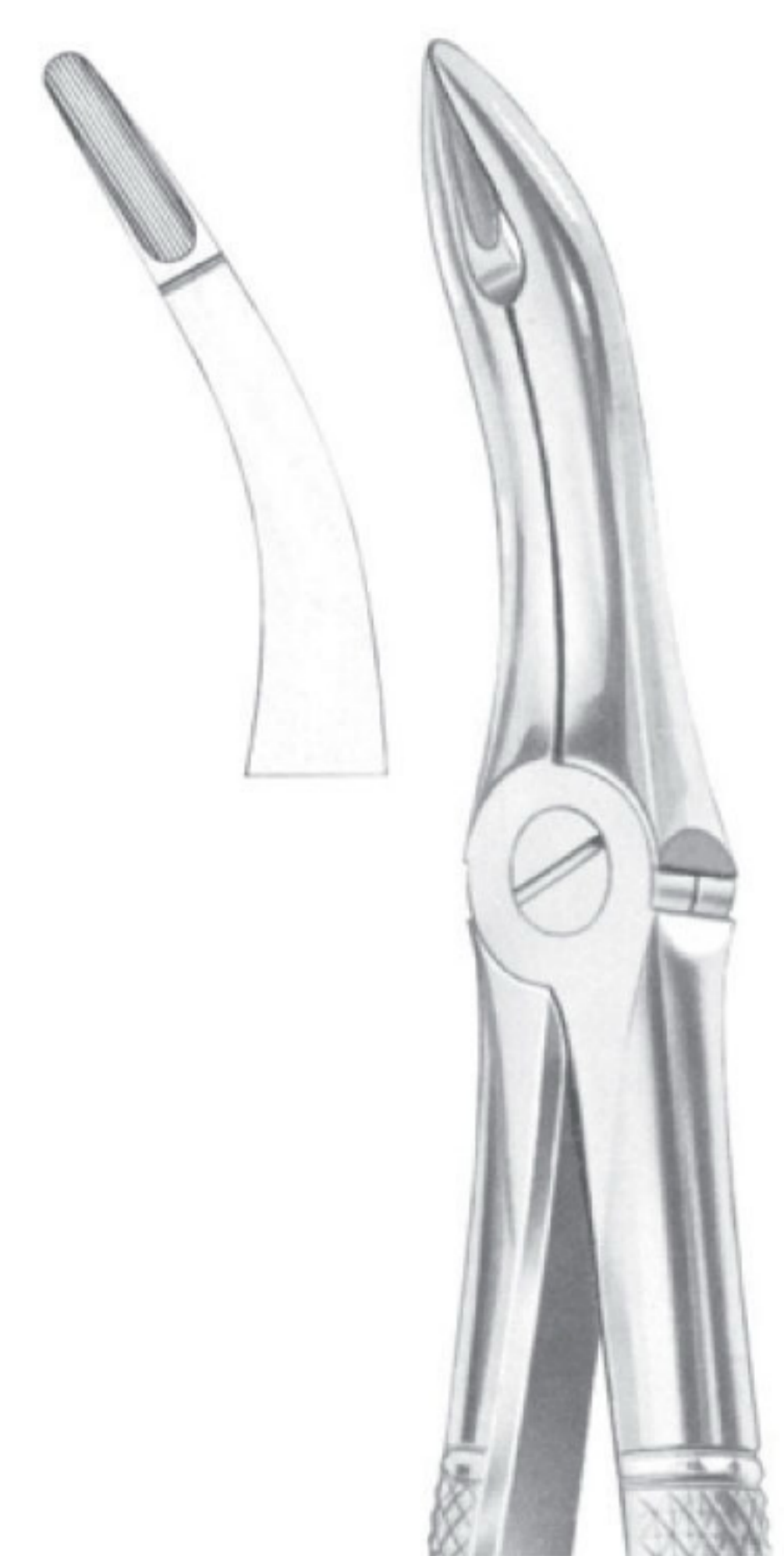

**Fig. 44 upper roots
MWD-1042**
Fig. 44 upper roots

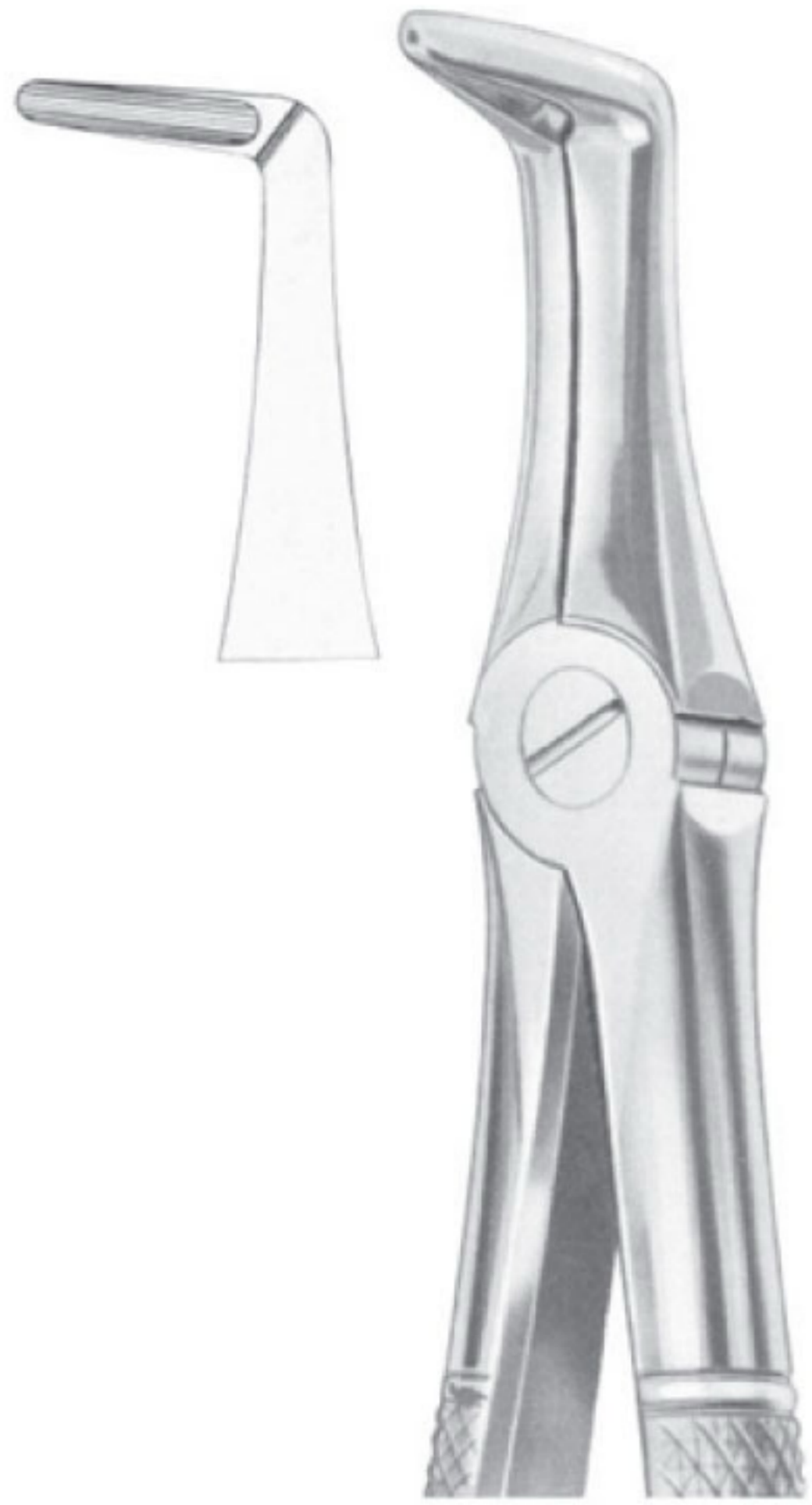

Fig. 45 lower roots
MWD-1043
Fig. 45 lower roots

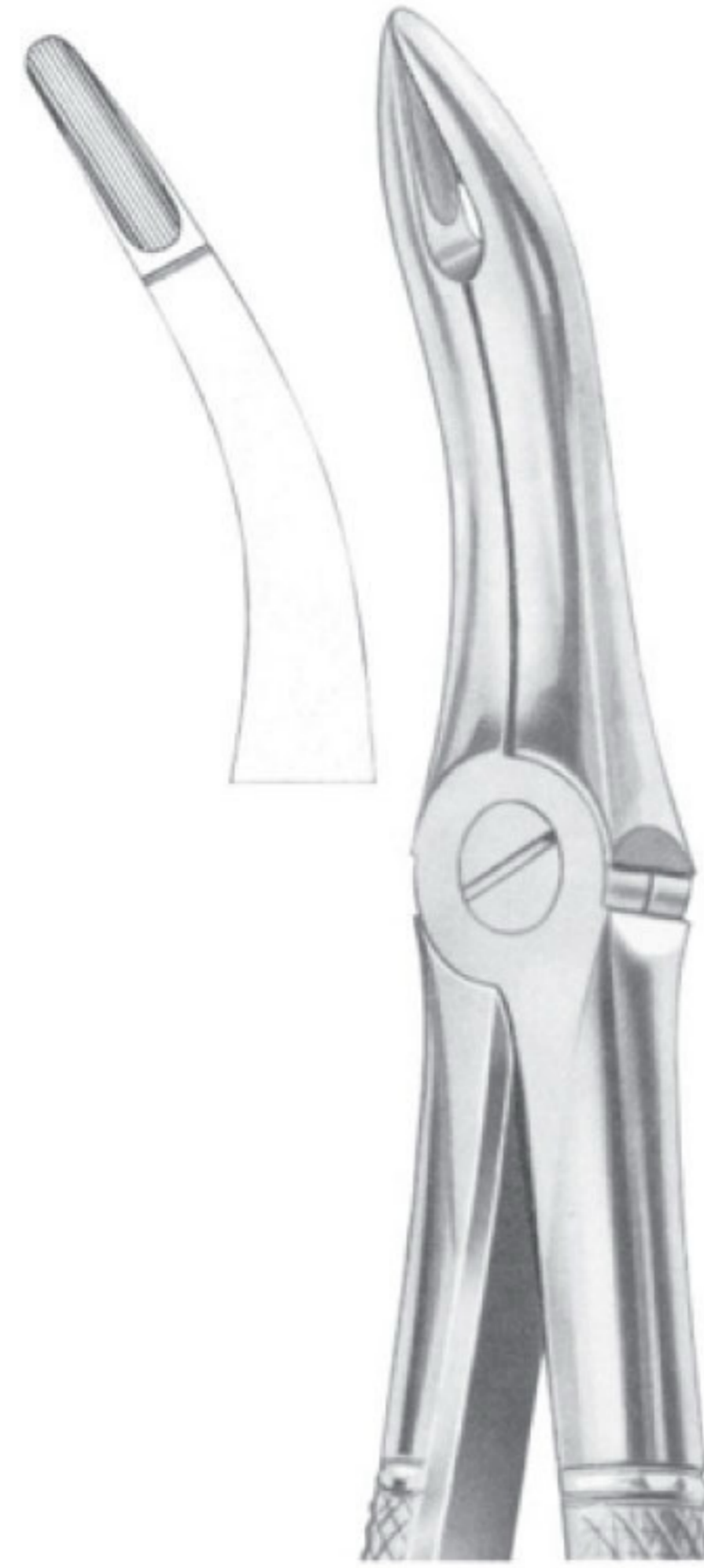

Fig. 48 lower roots
MWD-1044
Fig. 48 lower roots

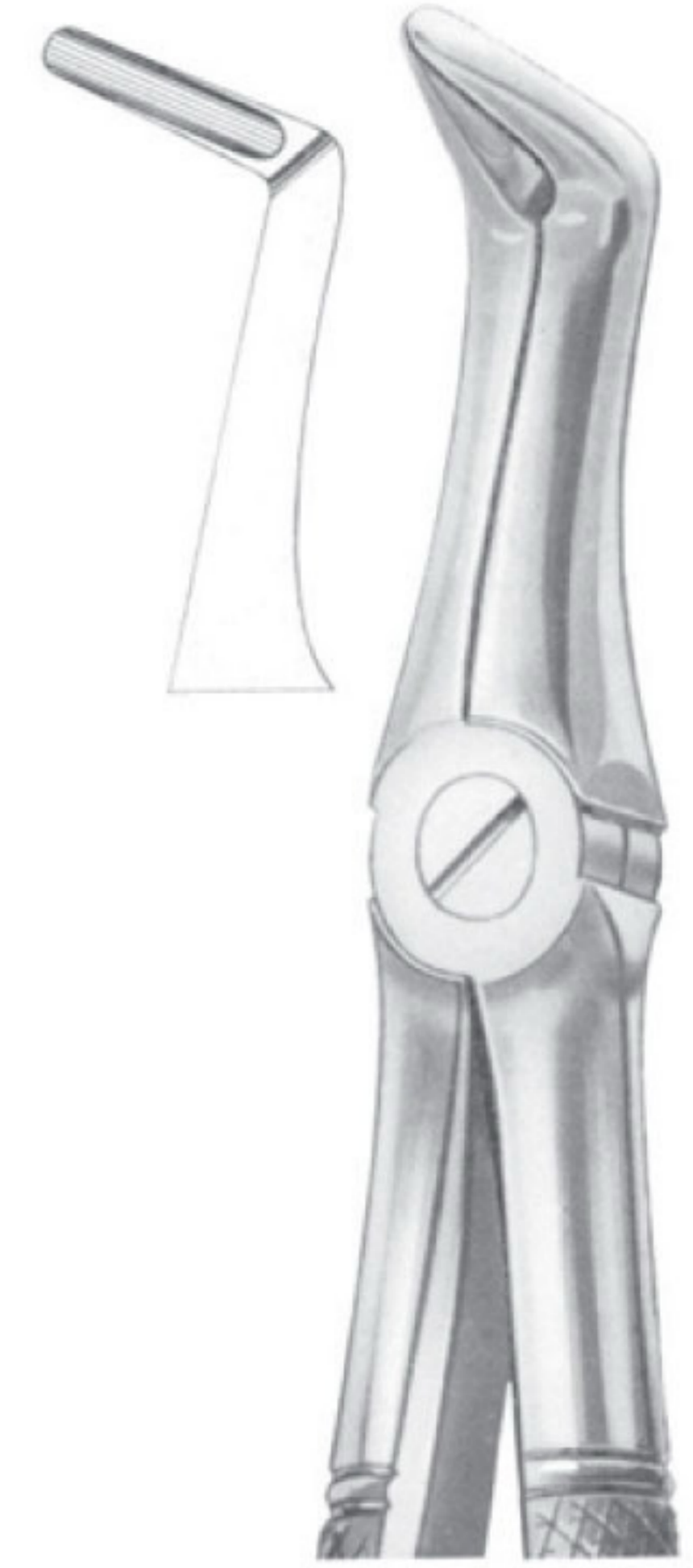

Fig. 49 upper roots
MWD-1045
Fig. 49 upper roots



Fig. 50 upper roots
MWD-1046
Fig. 50 upper roots



Fig. 51 upper roots
MWD-1047
Fig. 51 upper roots



Fig. 51A upper roots
MWD-1048
Fig. 51A upper roots



Fig. 51L upper roots
MWD-1049
Fig. 51L upper roots



Fig. 52 upper roots
MWD-1050
Fig. 52 upper roots

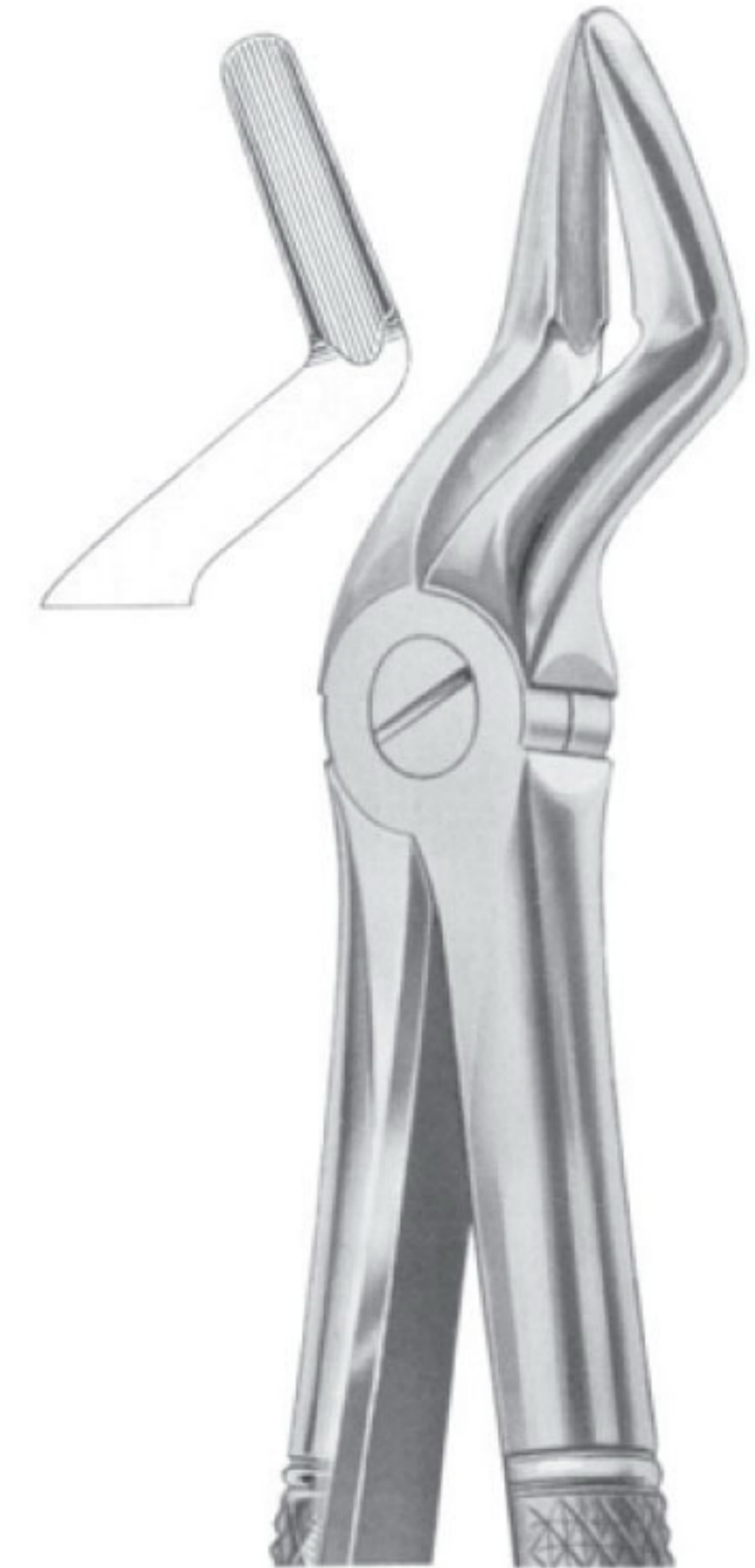

Fig. 52A upper teeth and resection
MWD-1051
Fig. 52A upper teeth and resection



Fig. 51S upper roots for children
MWD-1052
Fig. 51S upper roots for children



Fig. 54 for separating upper molars
MWD-1053
Fig. 54 for separating upper molars



Fig. 55 for separating upper molars
MWD-1054
Fig. 55 for separating upper molars



Fig. 56 for separating lower molars
MWD-1055
 Fig. 56 for separating lower molars

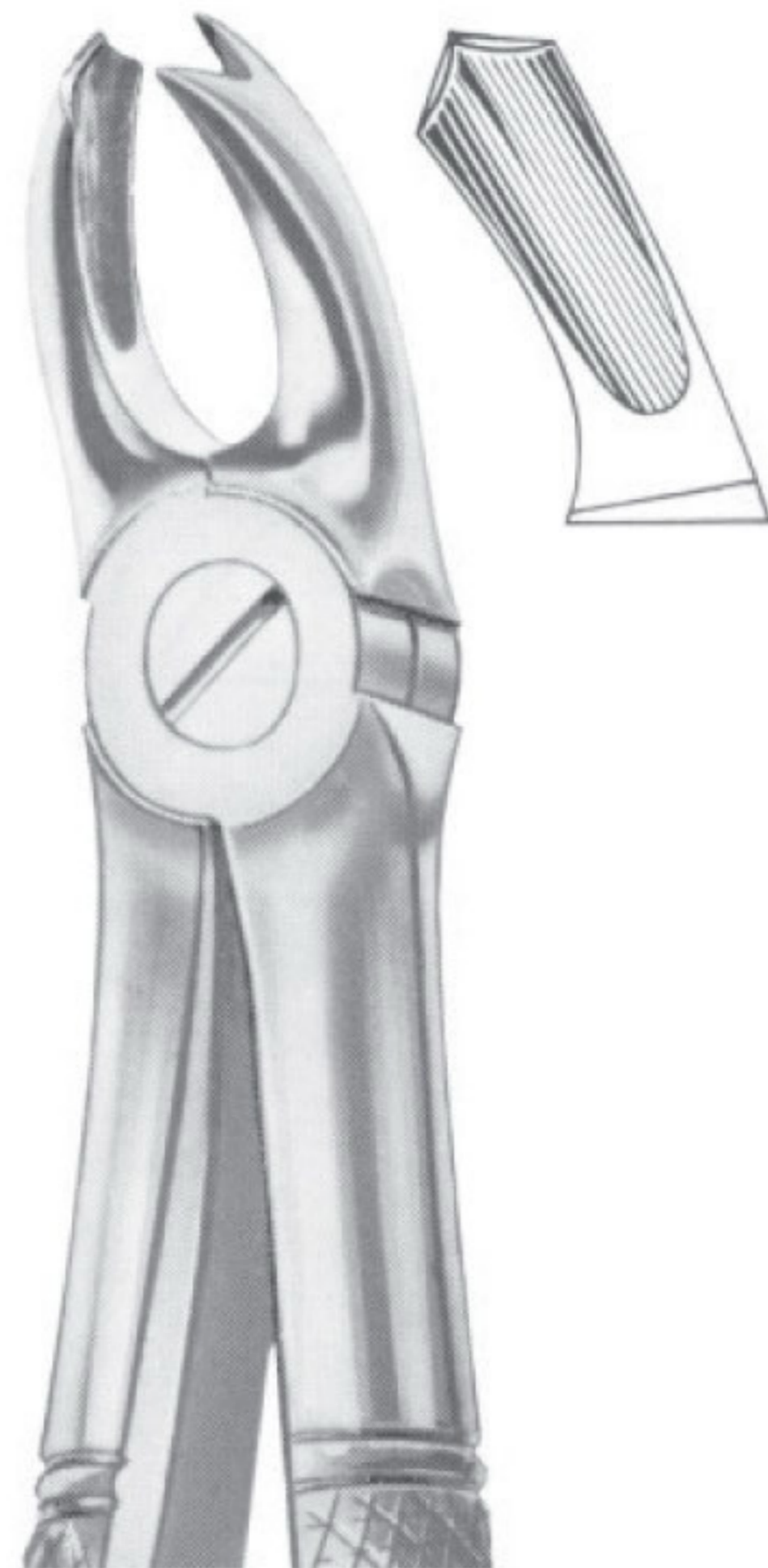

Fig. 65R upper molars right
MWD-1056
 Fig. 65R upper molars right

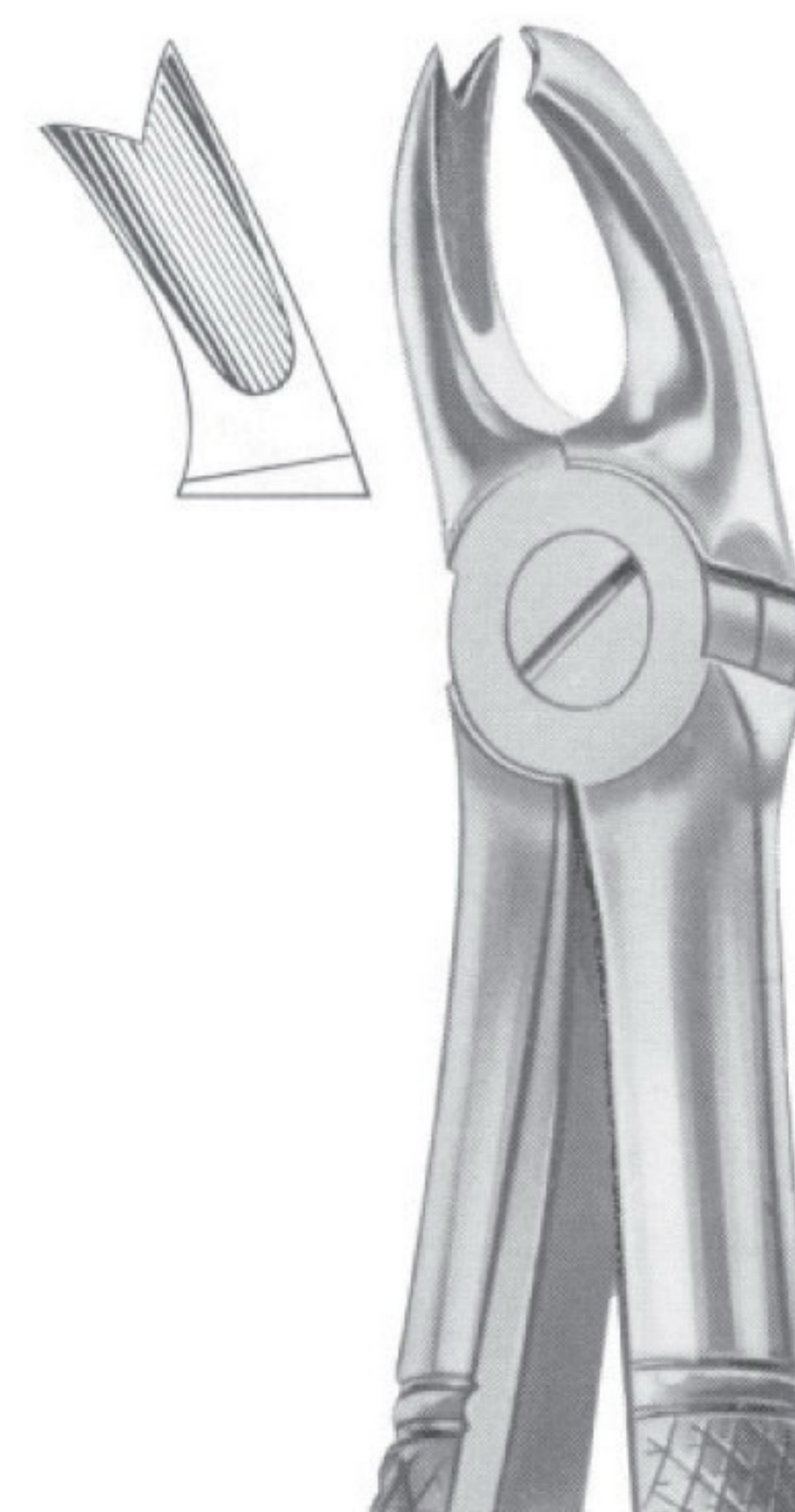

Fig. 65L upper molars left
MWD-1057
 Fig. 65L upper molars left



Fig. 67 upper third molars
MWD-1058
 Fig. 67 upper third molars



Fig. 67A upper third molars
MWD-1059
 Fig. 67A upper third molars



Fig. 67 1/2R upper third molars right
MWD-1060
 Fig. 67 1/2R upper third molars right



Fig. 67 1/2L upper third molars left
MWD-1061
 Fig. 67 1/2L upper third molars left



Fig. 68 lower roots
MWD-1062
 Fig. 68 lower roots



Fig. 68A lower roots
MWD-1063
 Fig. 68A lower roots

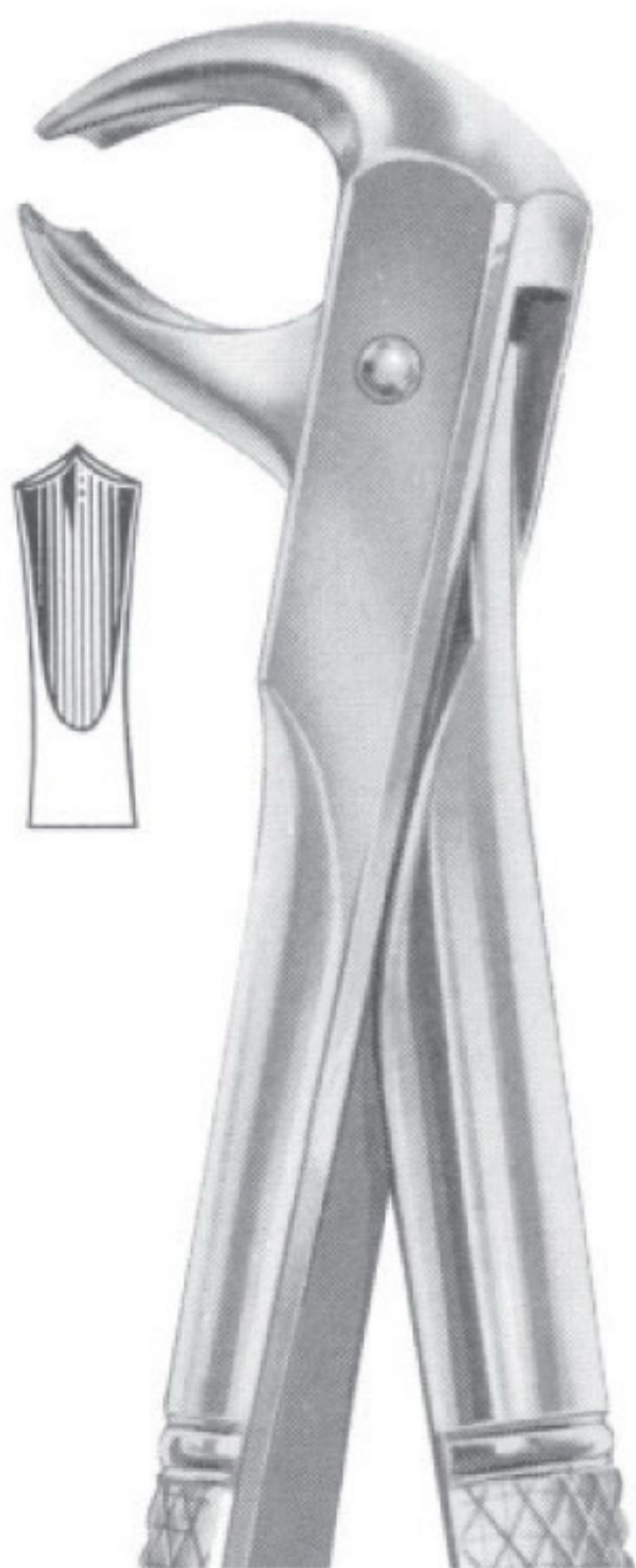

Fig. 73 lower molars
MWD-1064
 Fig. 73 lower molars

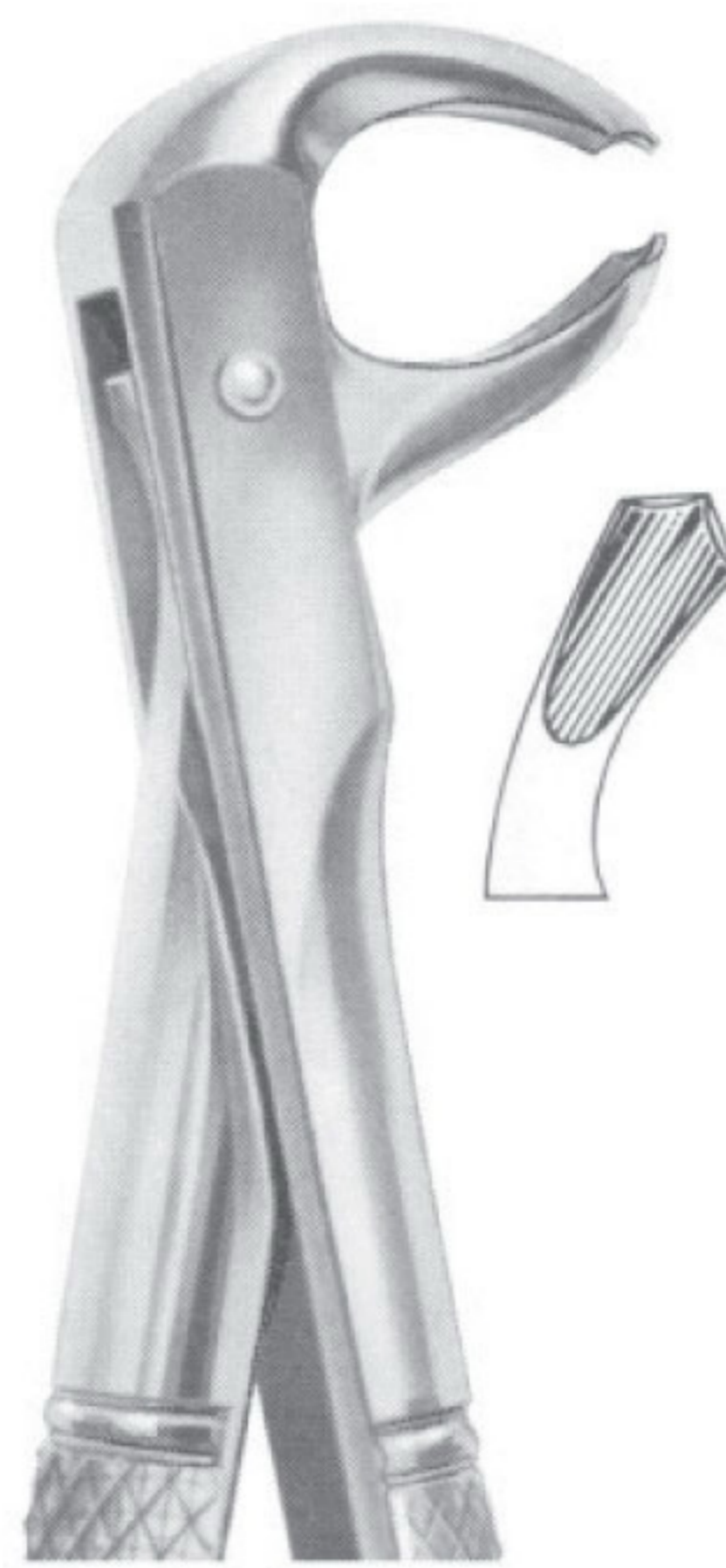

Fig. 73R lower molars right
MWD-1065
 Fig. 73R lower molars right

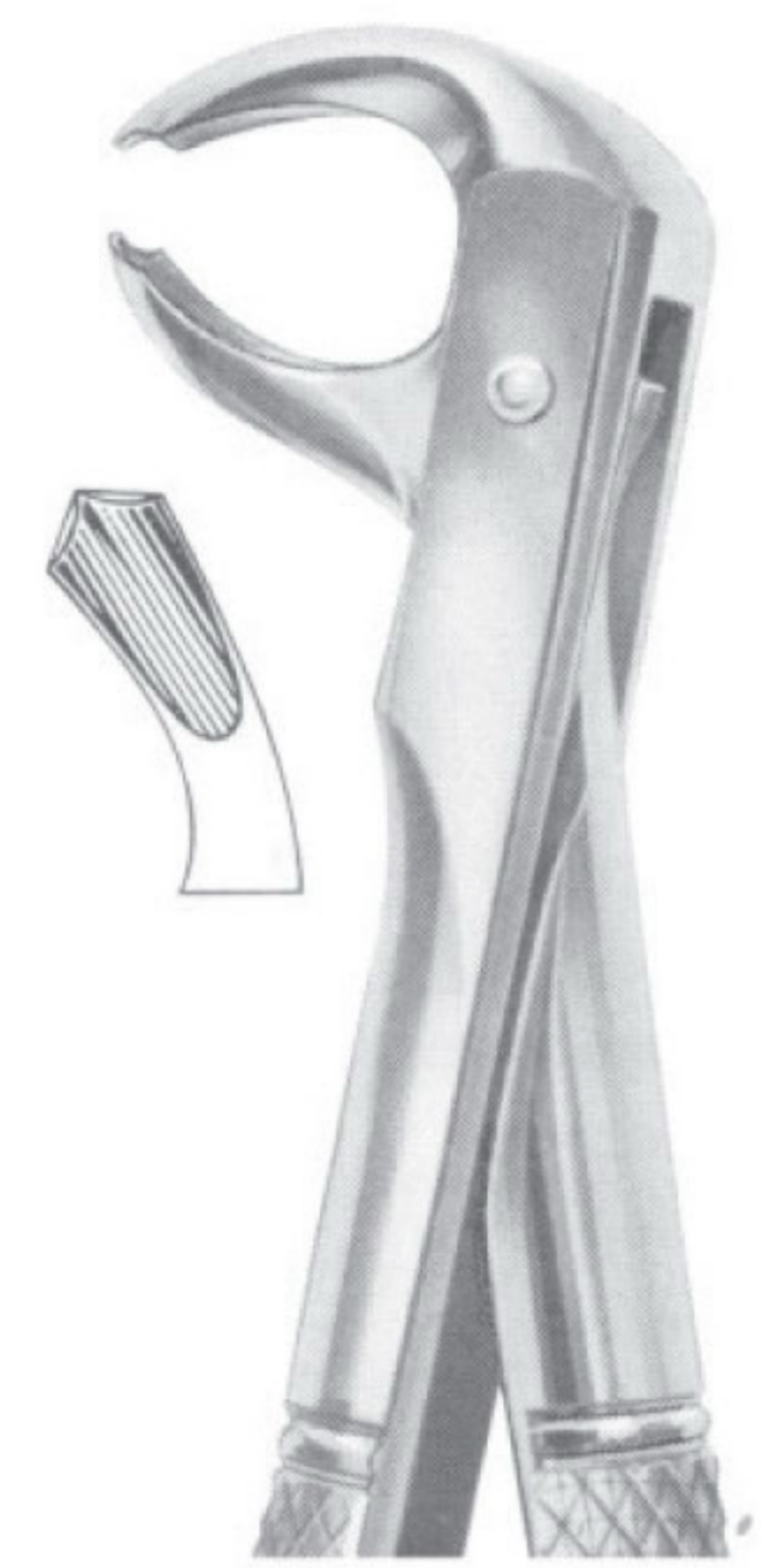

Fig. 73L lower molars left
MWD-1066
 Fig. 73L lower molars left



Fig. 73A lower molars
MWD-1067
Fig. 73A lower molars

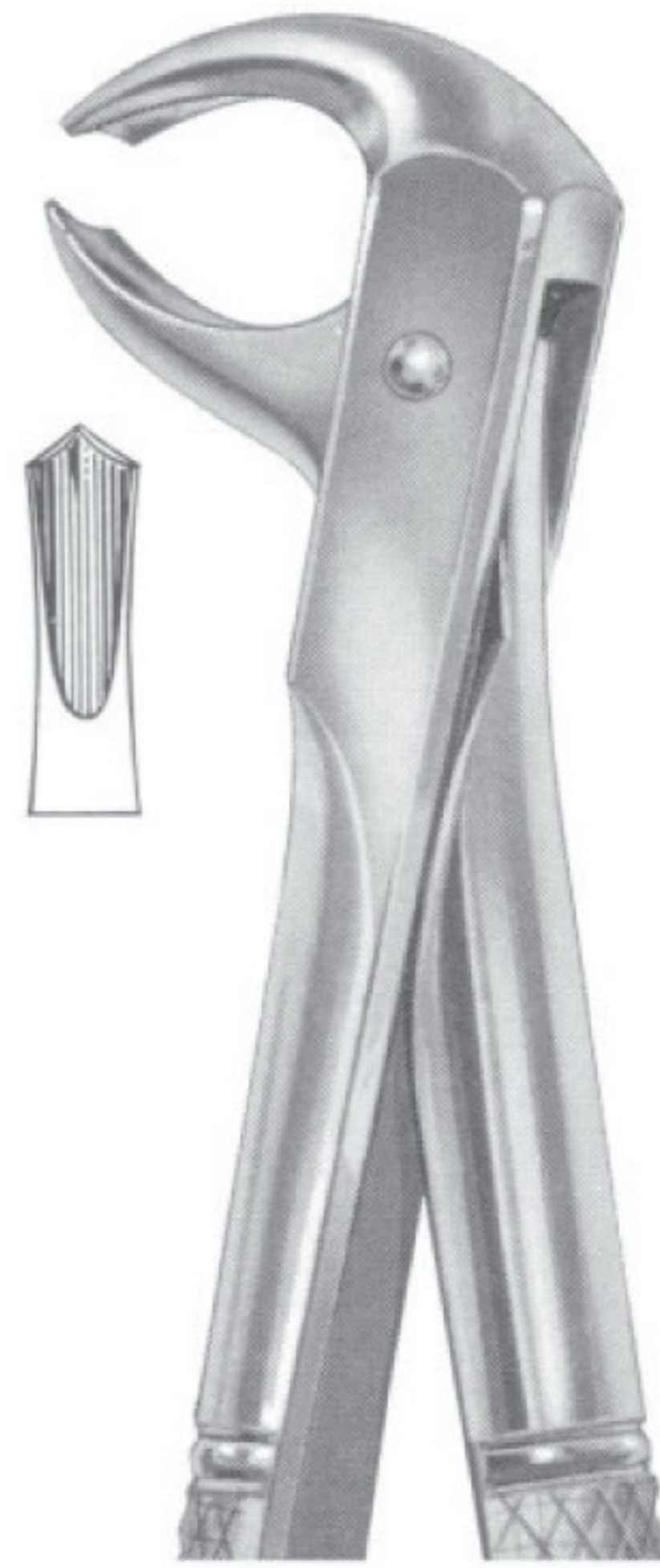

Fig. 73S lower molars
MWD-1068
Fig. 73S lower molars

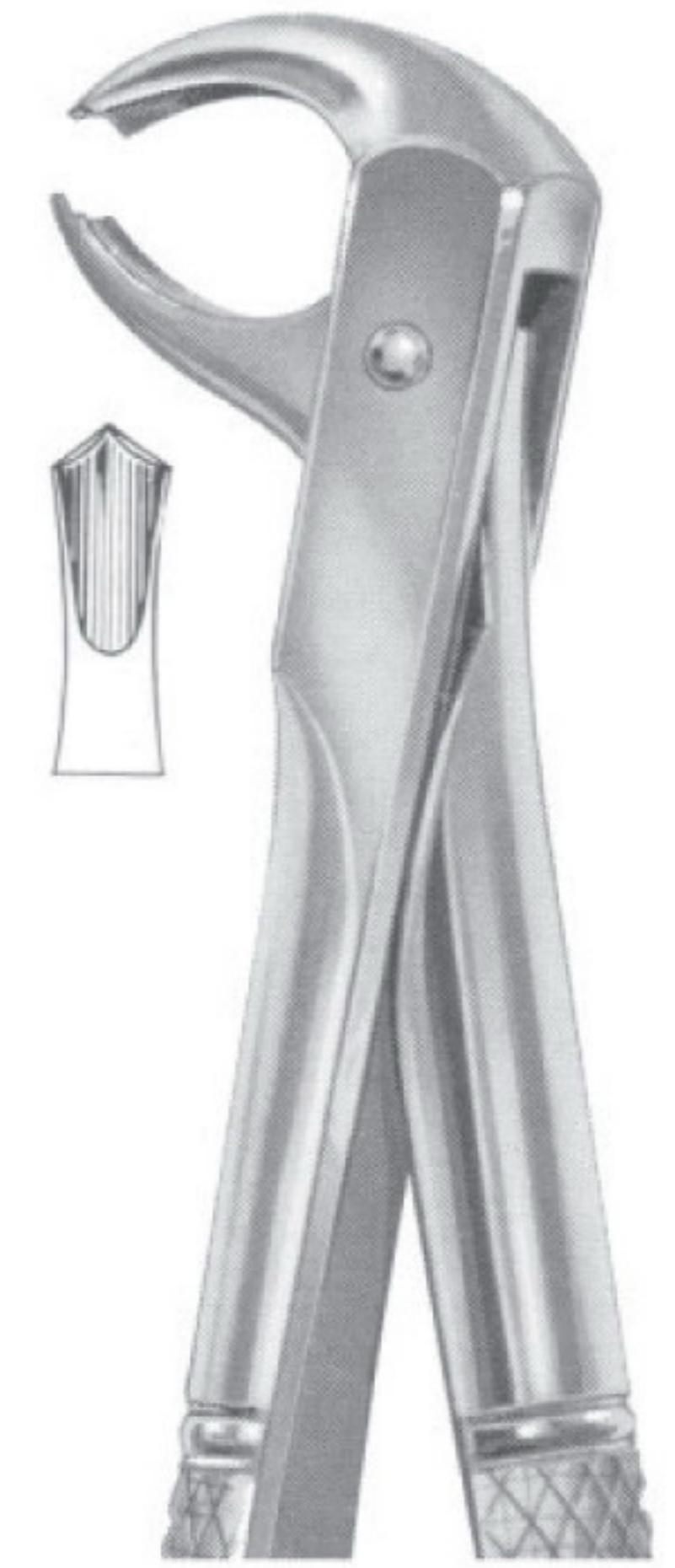

Fig. 73B lower molars for children
MWD-1069
Fig. 73B lower molars for children

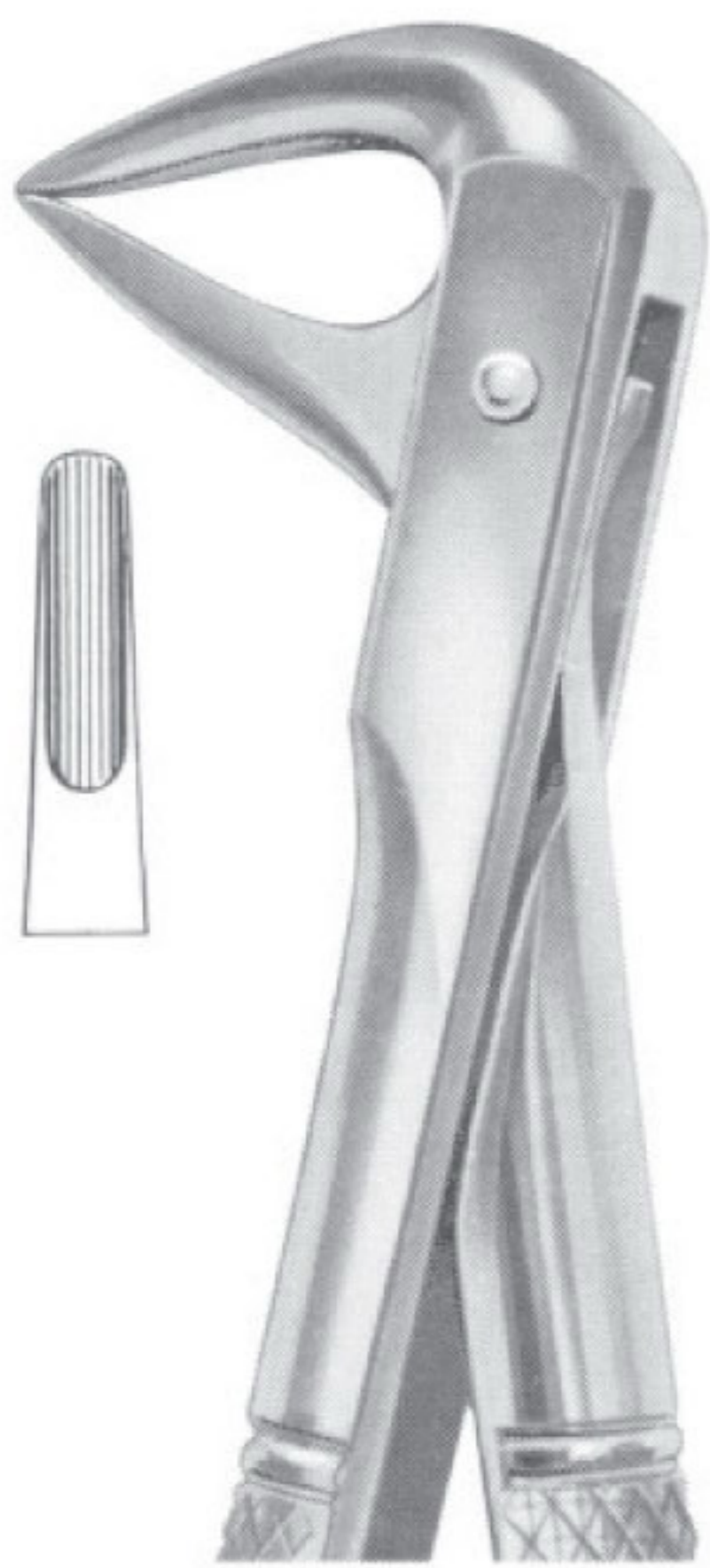

Fig. 74 lower roots
MWD-1070
Fig. 74 lower roots

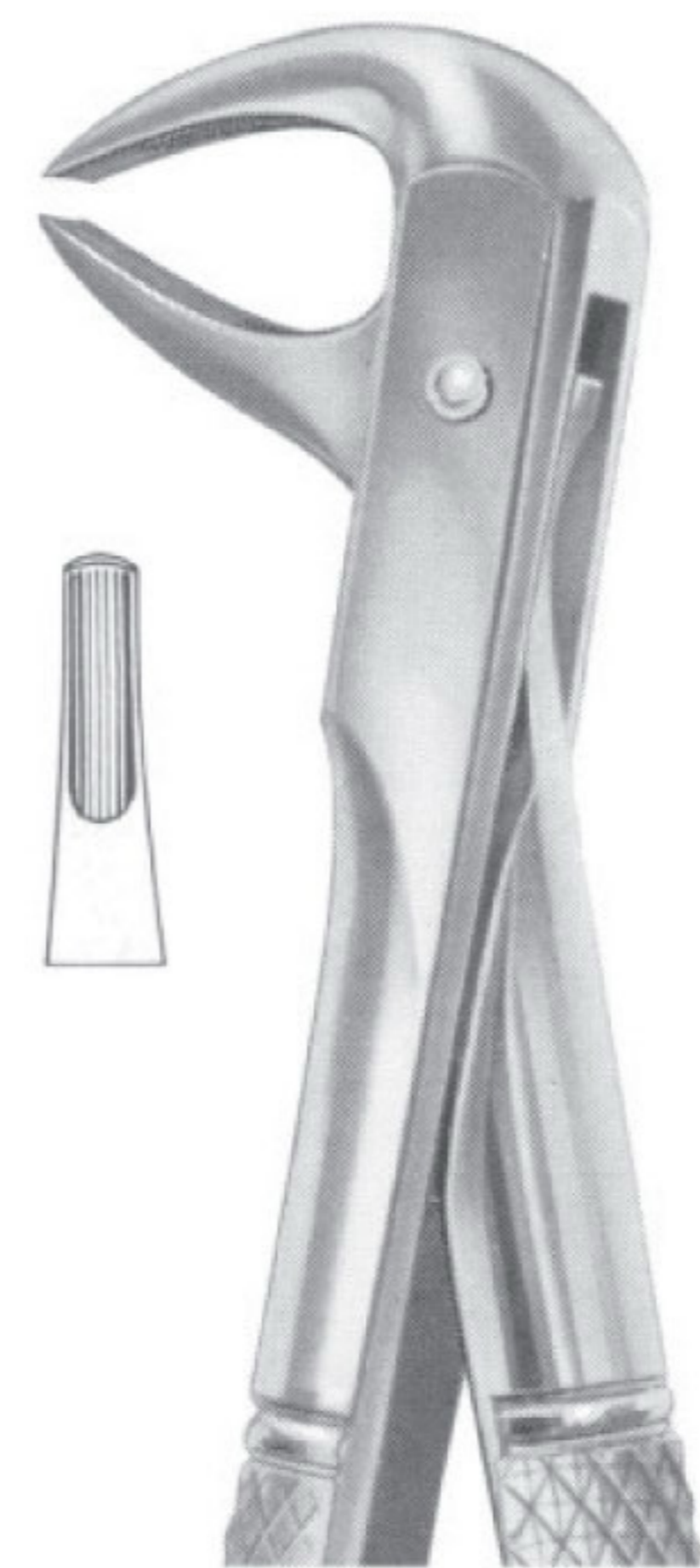

Fig. 74D lower roots
MWD-1071
Fig. 74D lower roots



Fig. 73K lower molars for children
MWD-1072
Fig. 73K lower molars for children



Fig. 74M lower roots
MWD-1073
Fig. 74M lower roots

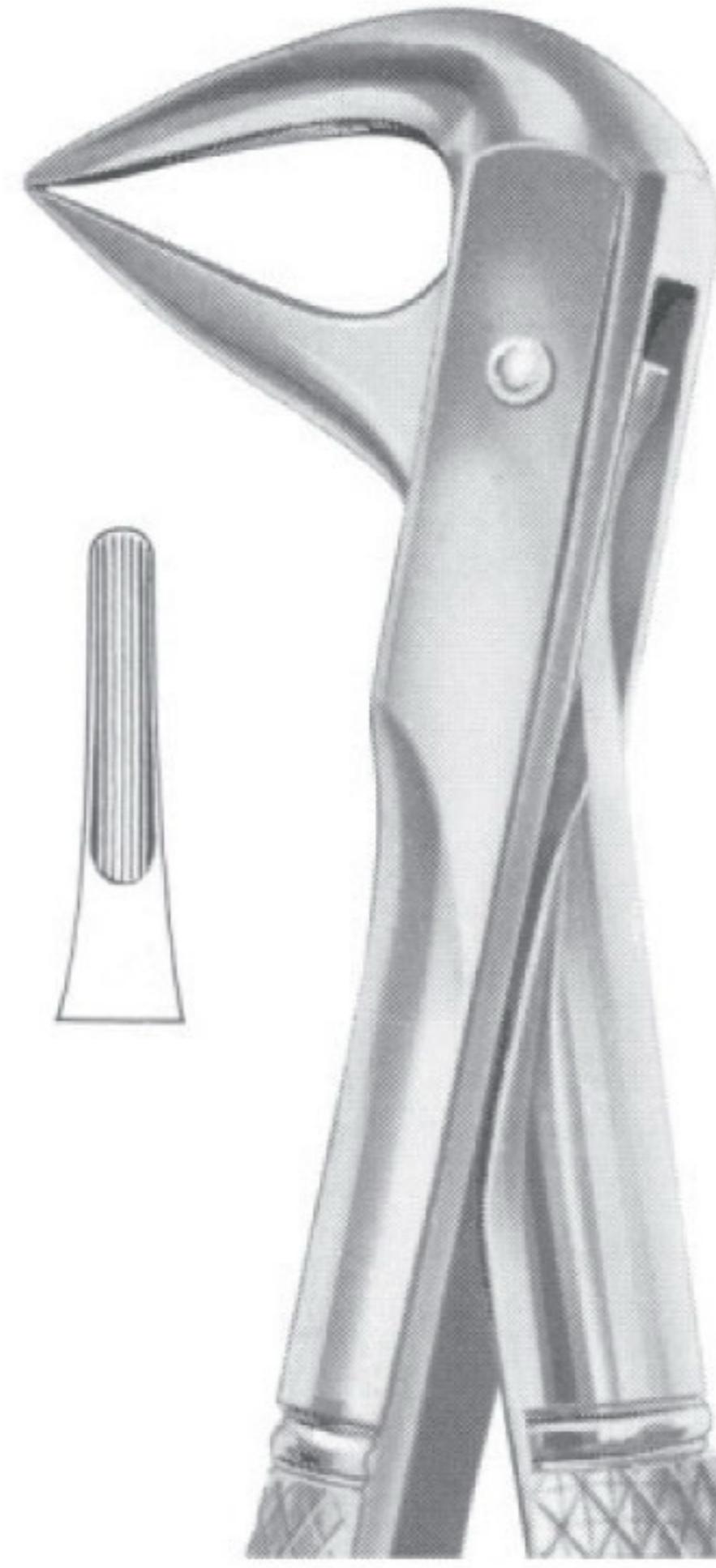

Fig. 74N lower roots
MWD-1074
Fig. 74N lower roots

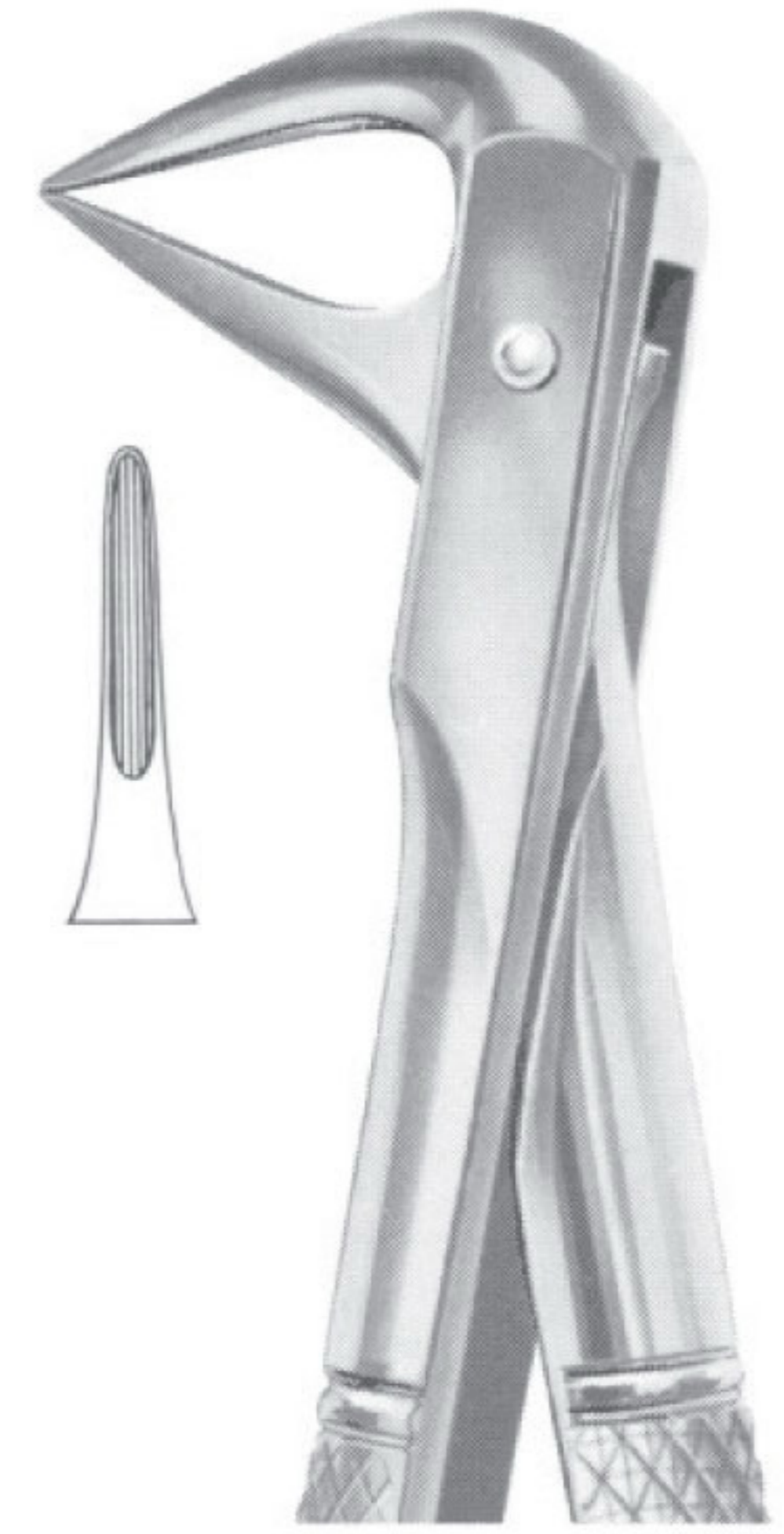

Fig. 74XN lower roots and crowded incisors
MWD-1075
Fig. 74XN lower roots and crowded incisors

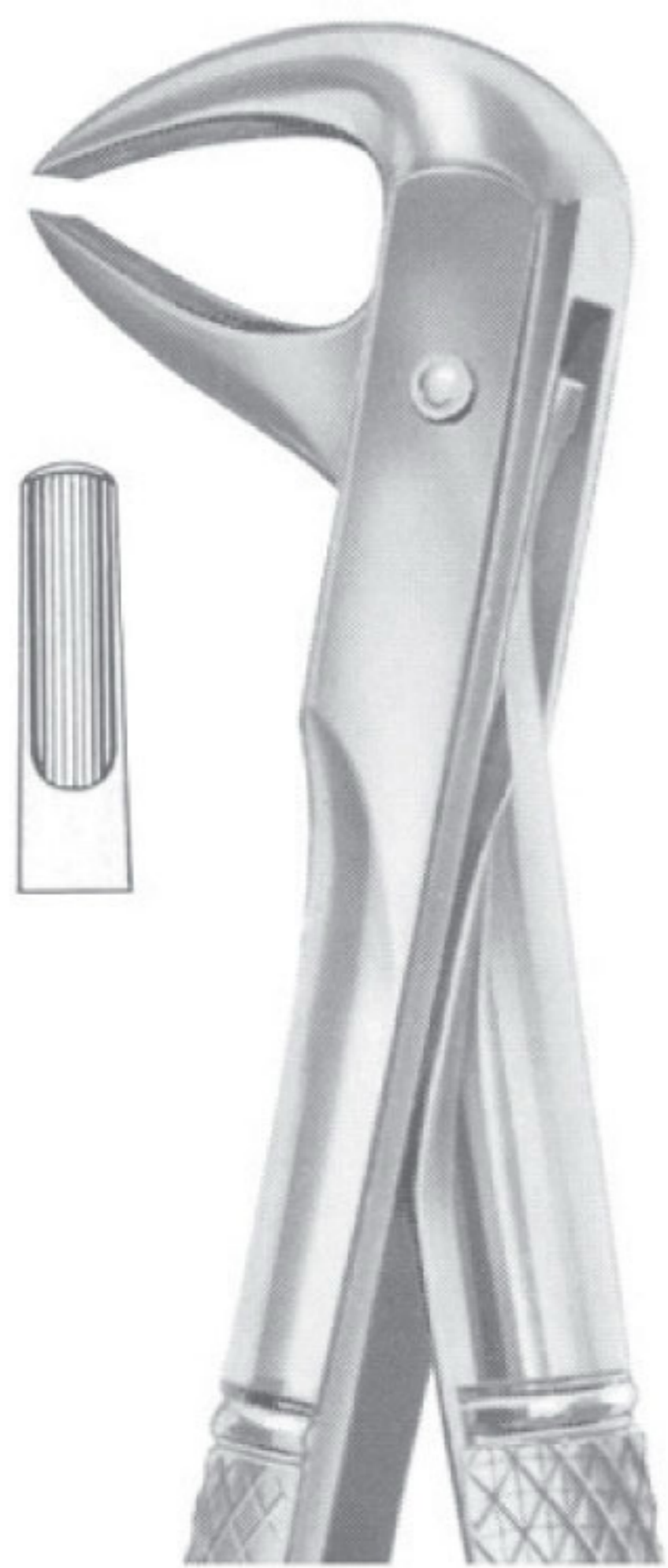

Fig. 75 lower premolars
MWD-1076
Fig. 75 lower premolars



Fig. 76 upper roots
MWD-1077
Fig. 76 upper roots



Fig. 76N upper roots
MWD-1078
Fig. 76N upper roots



Fig. 76S upper roots
MWD-1079
 Fig. 76S upper roots



Fig. 79 lower third molars
MWD-1080
 Fig. 79 lower third molars



Fig. 79A lower third molars
MWD-1081
 Fig. 79A lower third molars

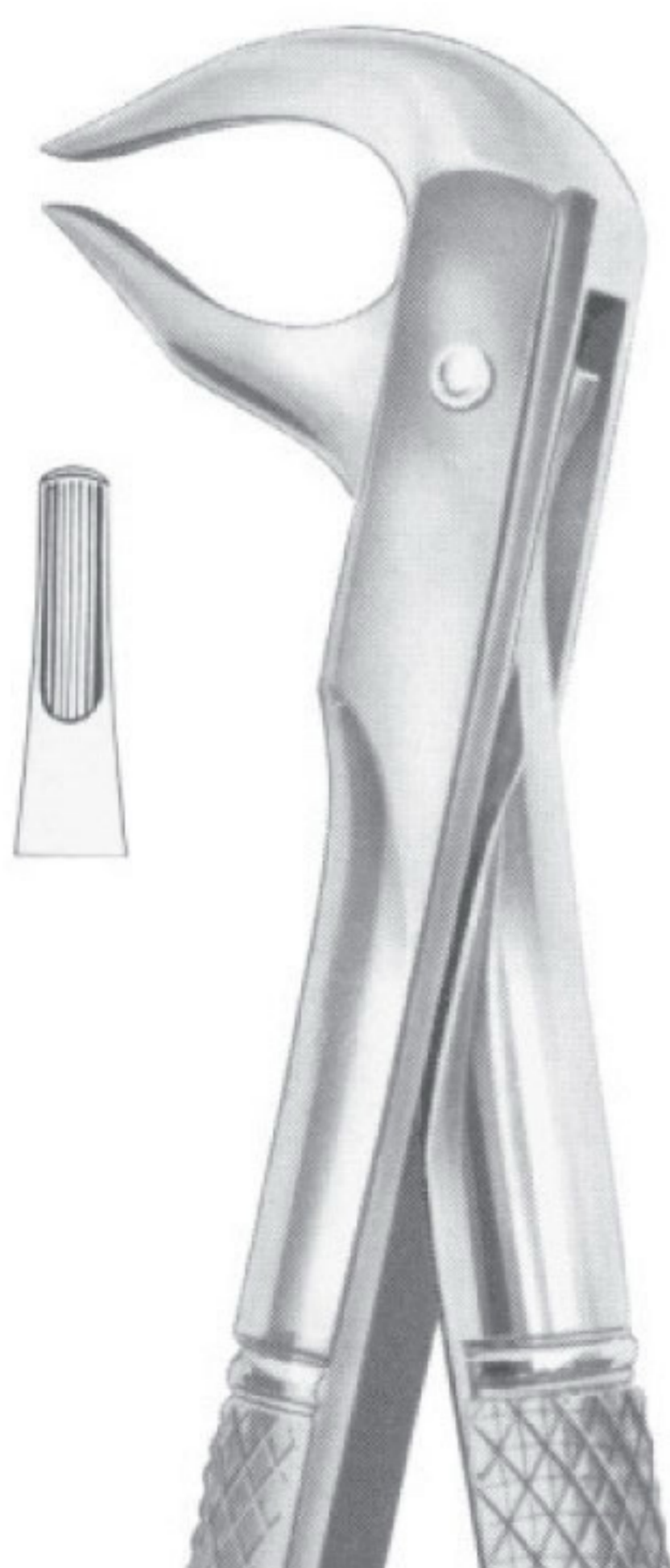

Fig. 81 lower premolars and roots
MWD-1082
 Fig. 81 lower premolars and roots



Fig. 86A lower molars
MWD-1083
 Fig. 86A lower molars



Fig. 86B lower molars
MWD-1084
 Fig. 86B lower molars

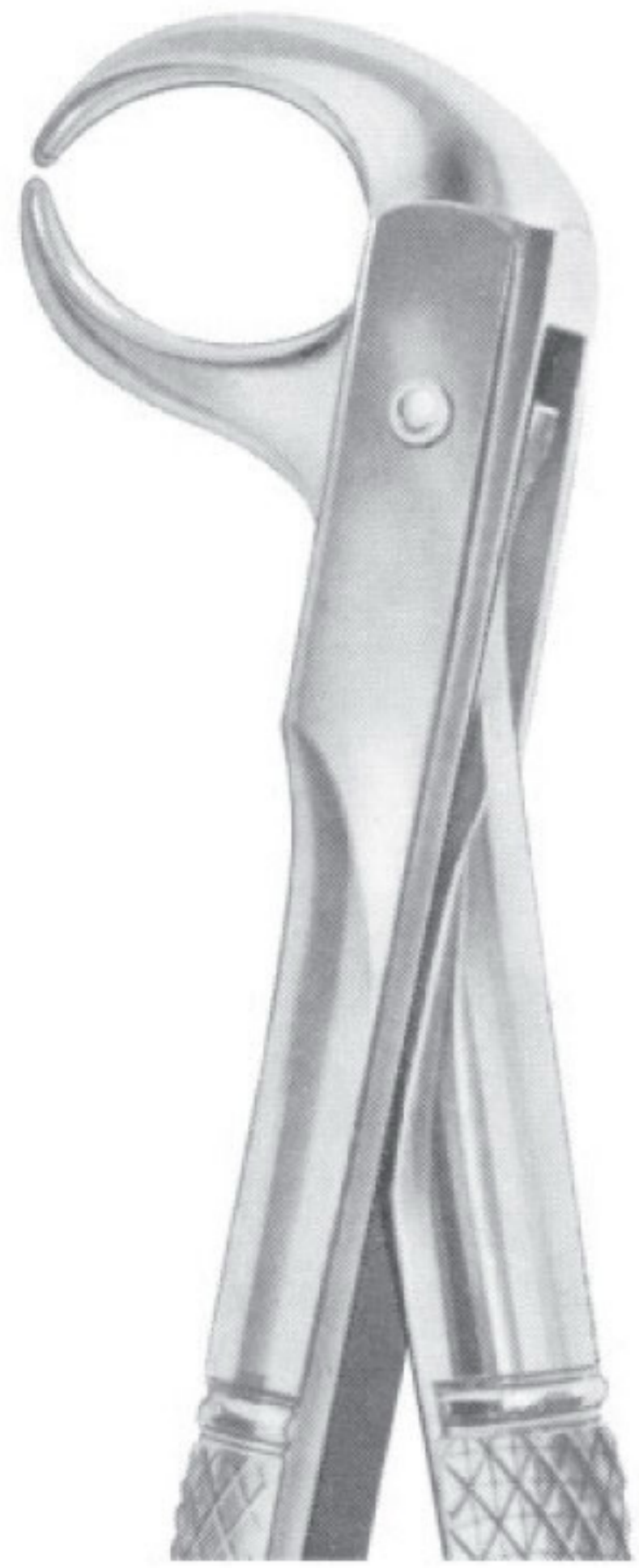

Fig. 86C lower molars
MWD-1085
Fig. 86C lower molars



Fig. 87 lower molars
MWD-1086
Fig. 87 lower molars



Fig. 91 for separating lower molars
MWD-1087
Fig. 91 for separating lower molars



Fig. 99 lower molars
MWD-1088
Fig. 99 lower molars



Fig. 101 upper premolars and roots
MWD-1089
Fig. 101 upper premolars and roots



Fig. 100 upper roots
MWD-1090
Fig. 100 upper roots



Fig. 99 1/4 lower molars
MWD-1091
Fig. 99 1/4 lower molars



Fig. 99 1/2 lower molars
MWD-1092
Fig. 99 1/2 lower molars



Fig. 102 upper molars right
MWD-1093
Fig. 102 upper molars right



Fig. 103 upper molars left
MWD-1094
Fig. 103 upper molars left

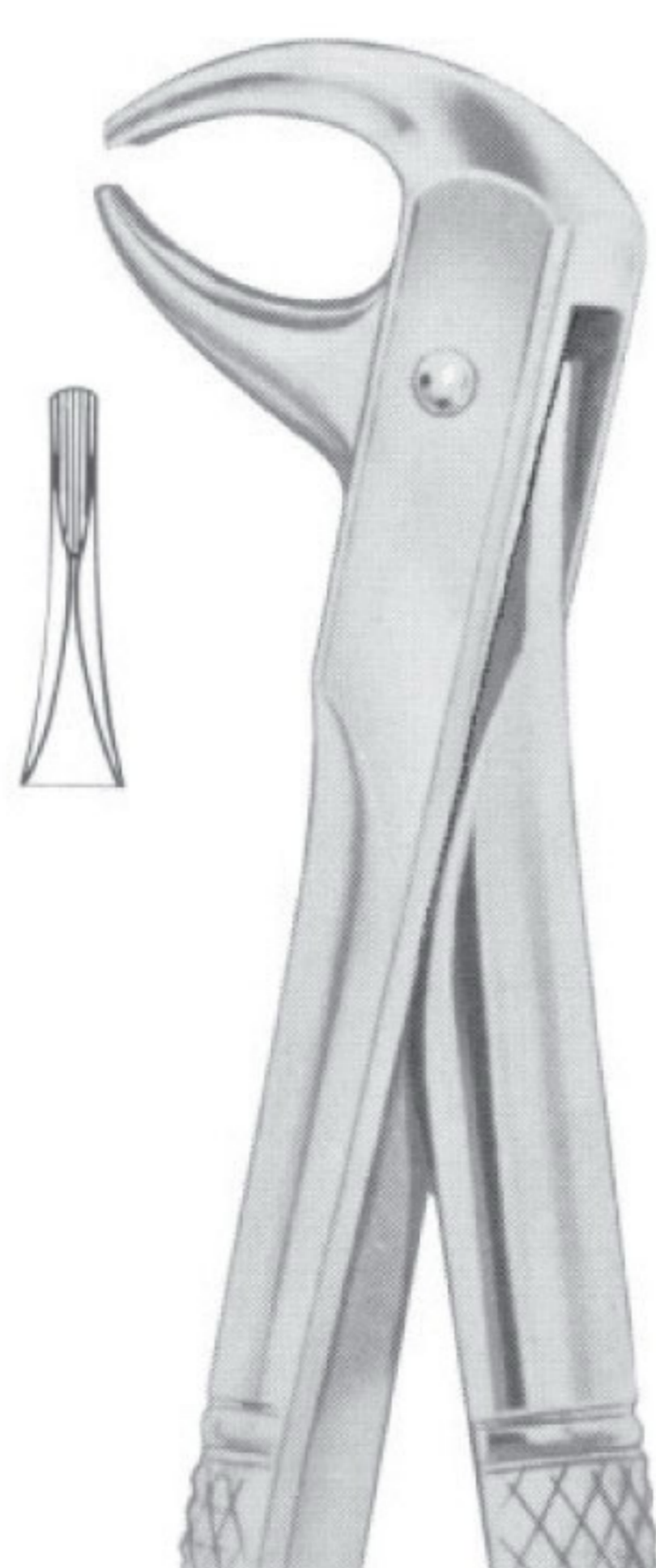

Fig. 105 lower incisors
MWD-1095
Fig. 105 lower incisors

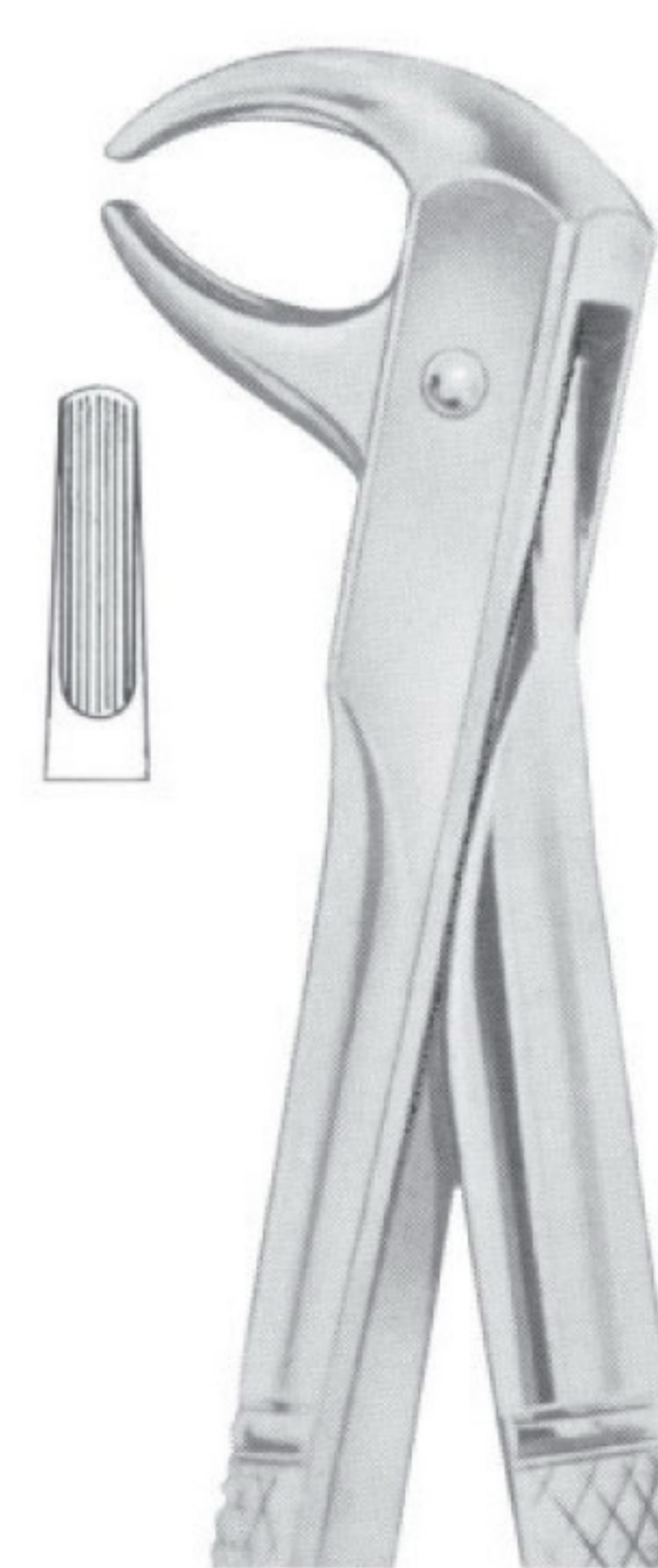

Fig. 106 lower incisors
MWD-1096
Fig. 106 lower incisors



Fig. 103 upper canines
MWD-1097
 Fig. 103 upper canines



Fig. 112 upper roots
MWD-1098
 Fig. 112 upper roots



Fig. 113 upper roots
MWD-1099
 Fig. 113 upper roots

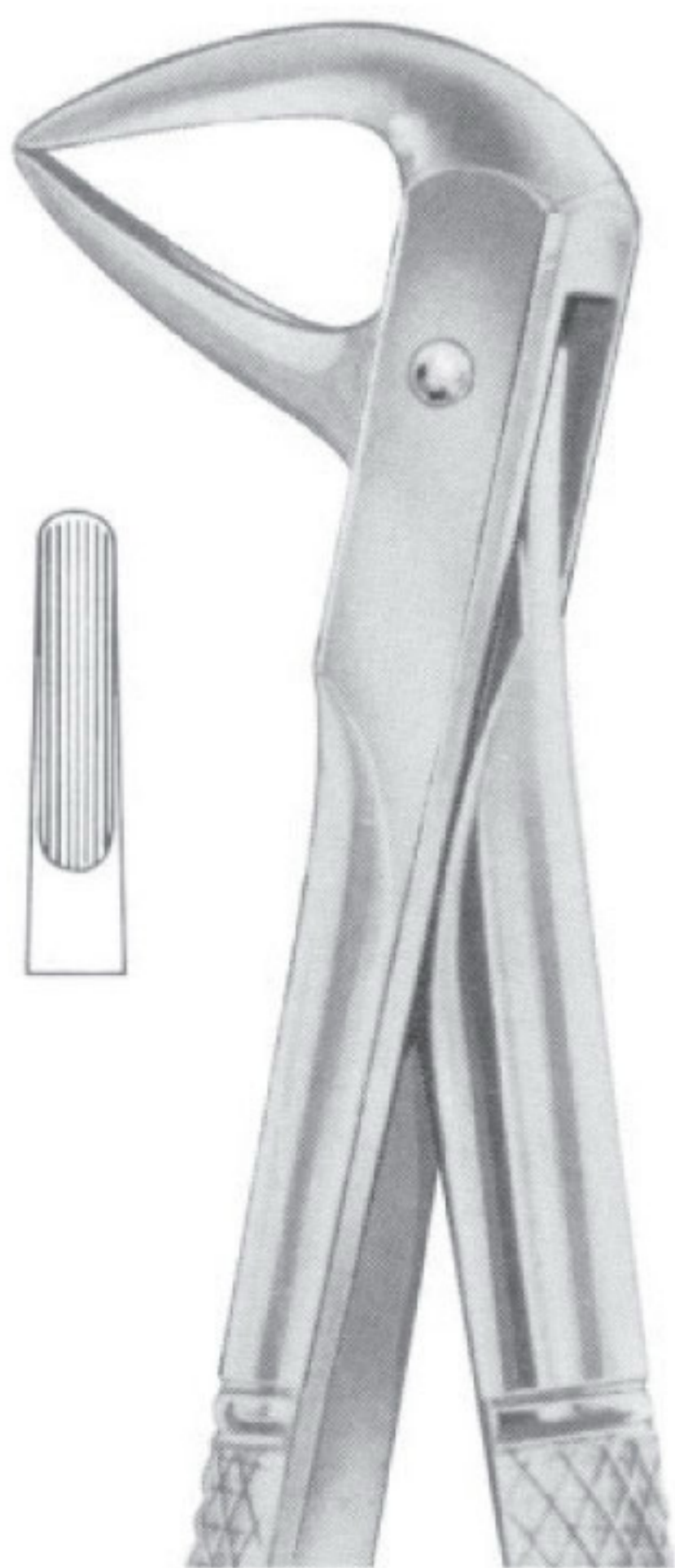

Fig. 114 upper roots
MWD-1100
 Fig. 114 upper roots



Fig. 136 upper premolars and roots
MWD-1101
 Fig. 136 upper premolars and roots

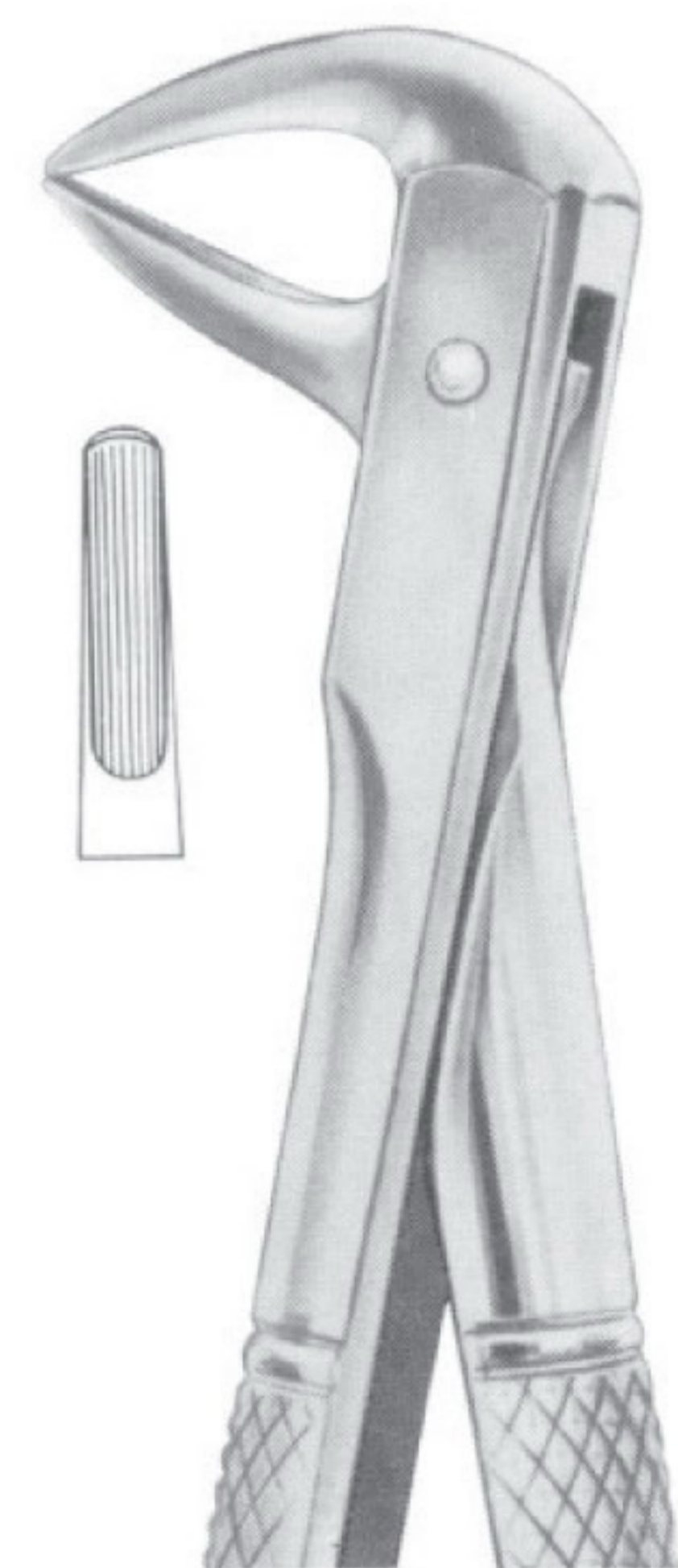

Fig. 137 lower incisors and roots
MWD-1102
 Fig. 137 lower incisors and roots

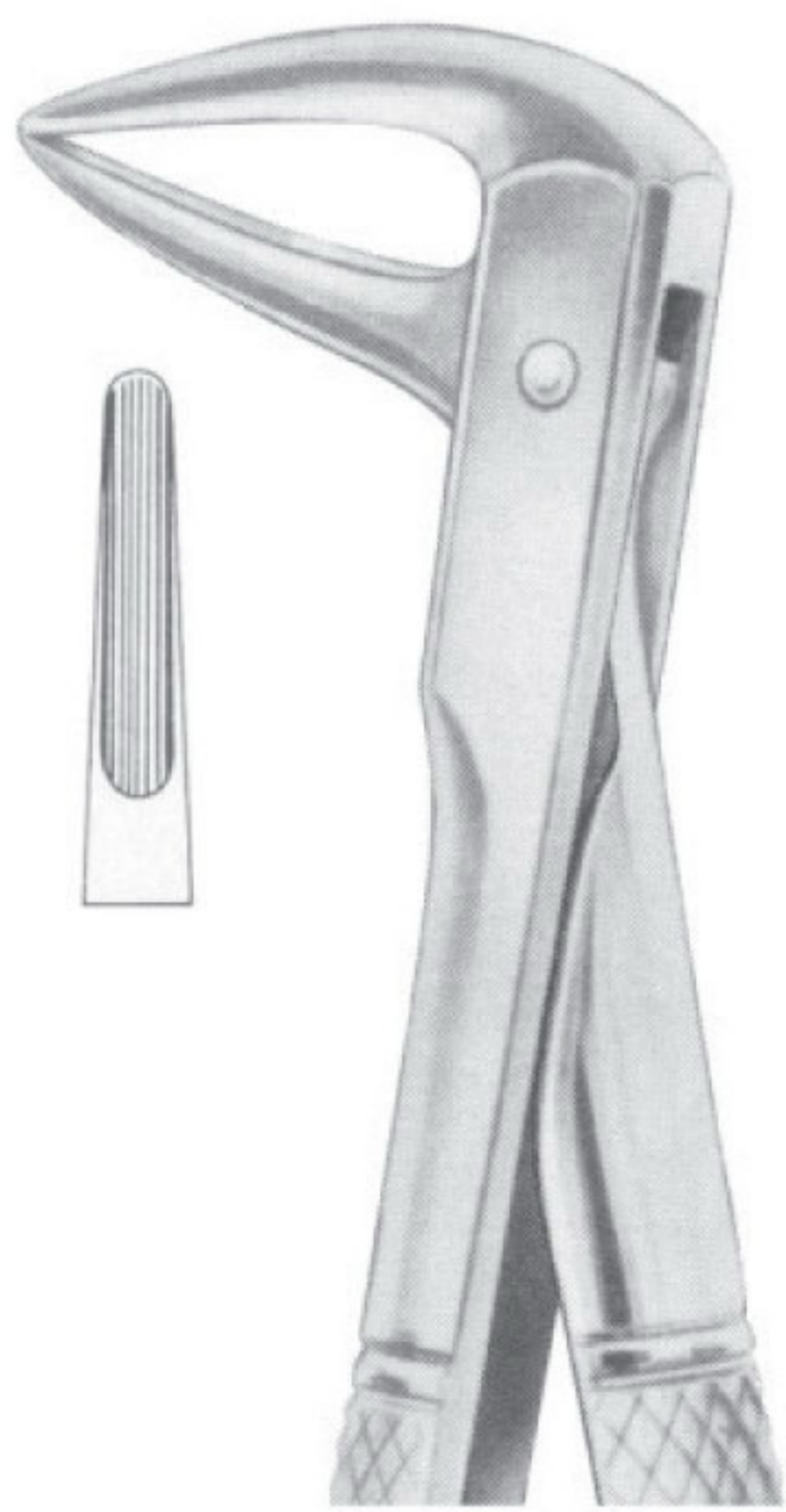
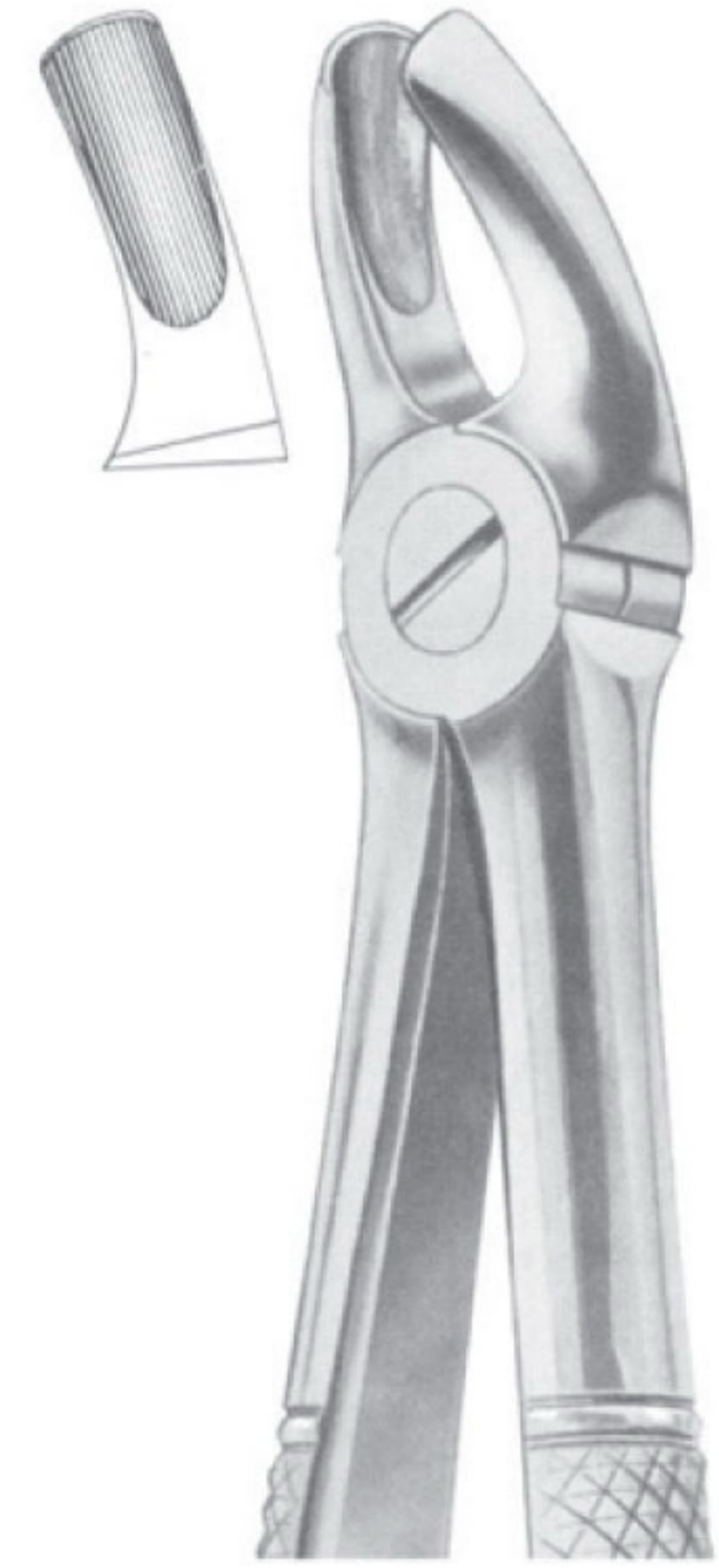

Fig. 143 lower roots
MWD-1103
 Fig. 143 lower roots



MEAD (MD 1) upper anteriors, roots, incisors, canines
MWD-1104
 MEAD (MD 1) upper anteriors, roots, incisors, canines



MEAD (MD 2) upper molars
MWD-1105
 MEAD (MD 2) upper molars

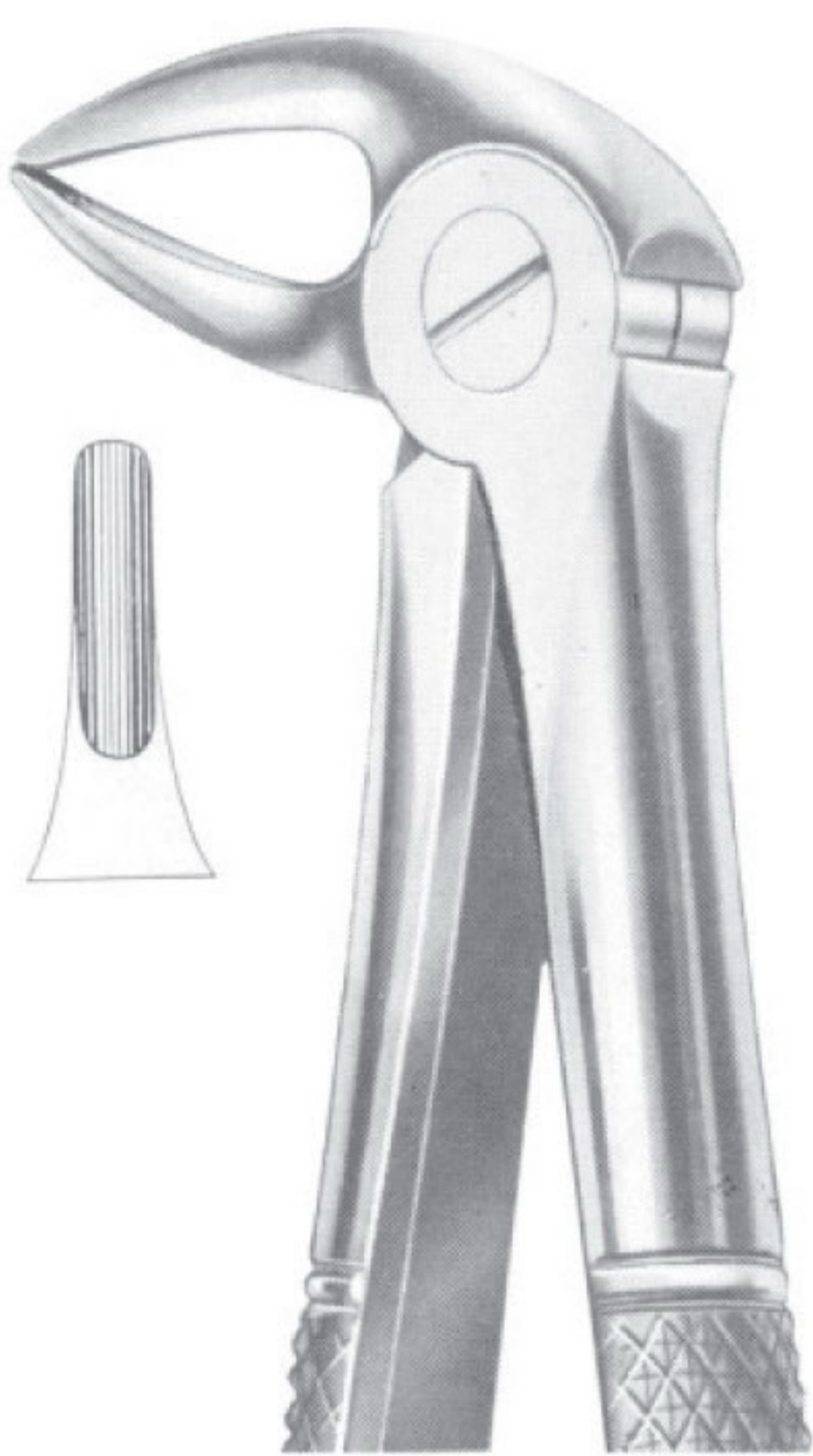

MEAD (MD 3) lower roots
MWD-1106
 MEAD (MD 3) lower roots



MEAD (MD 4) lower molars
MWD-1107
 MEAD (MD 4) lower molars



FELSCH (Fig. 210) upper third molars
MWD-1108
 FELSCH (Fig. 210) upper third molars



HERTZ (Fig. 211) lower incisors
MWD-1109

HERTZ (Fig. 211) lower incisors



ROUTURIER (Fig. 212) (22 ½ L) lower molars and wisdom left
MWD-1110

ROUTURIER (Fig. 212) (22 ½ L) lower molars and wisdom left



ROUTURIER (Fig. 213) (22 ½ R) lower molars and wisdom right
MWD-1111

ROUTURIER (Fig. 213) (22 ½ R) lower molars and wisdom right



ROUTURIER (Fig. 214) (22 ½ L) lower molars and wisdom left
MWD-1112

ROUTURIER (Fig. 214) (22 ½ L) lower molars and wisdom left



ROUTURIER (Fig. 215) (33 ½ R) lower molars and wisdom right
MWD-1113

ROUTURIER (Fig. 215) (33 ½ R) lower molars and wisdom right



RESECTION FORCEPS (216/Witzel) upper roots
MWD-1114

RESECTION FORCEPS (216/Witzel) upper roots



Fig. 5
MWD-1115
Fig. 5



Fig. 6
MWD-1116
Fig. 6

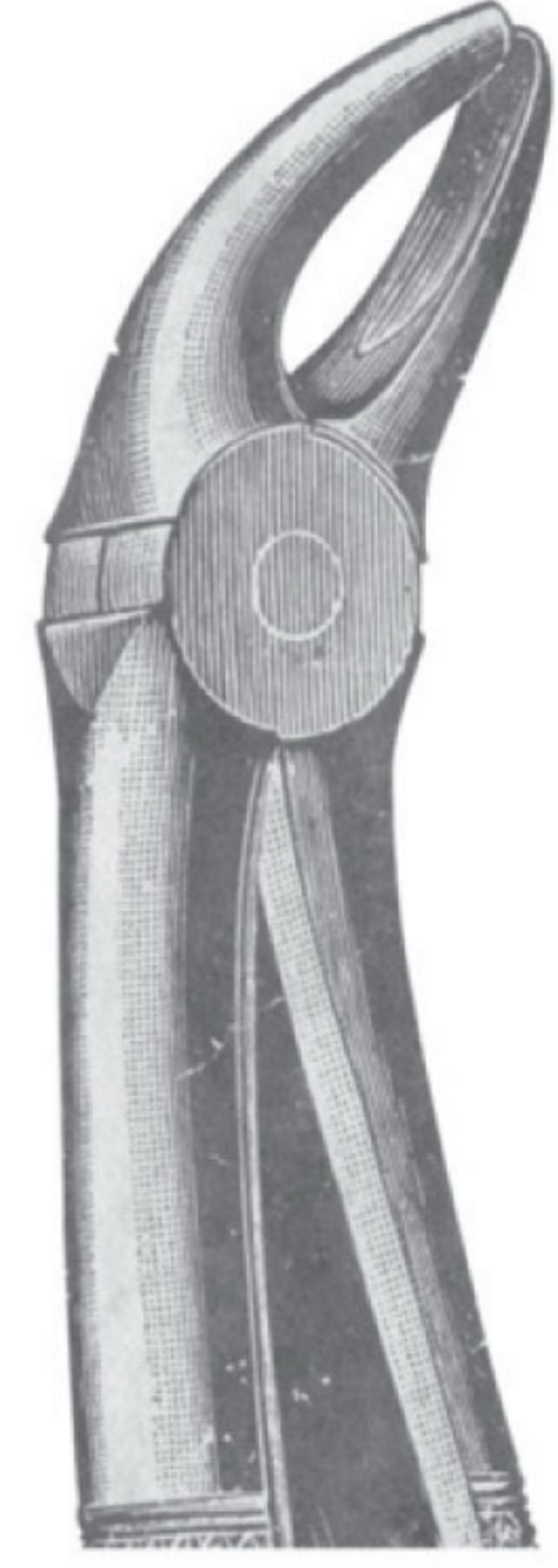

Fig. 9
MWD-1117
Fig. 9



Fig. 10
MWD-1118
Fig. 10

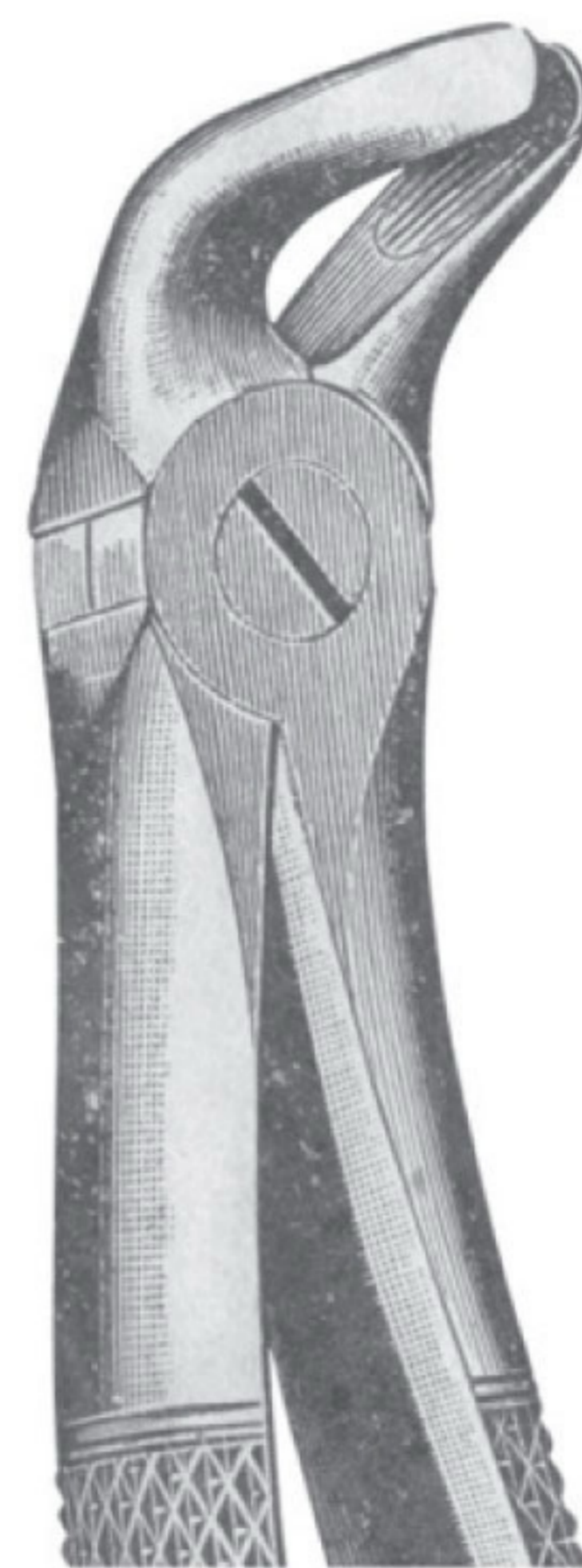

Fig. 11
MWD-1119
Fig. 11

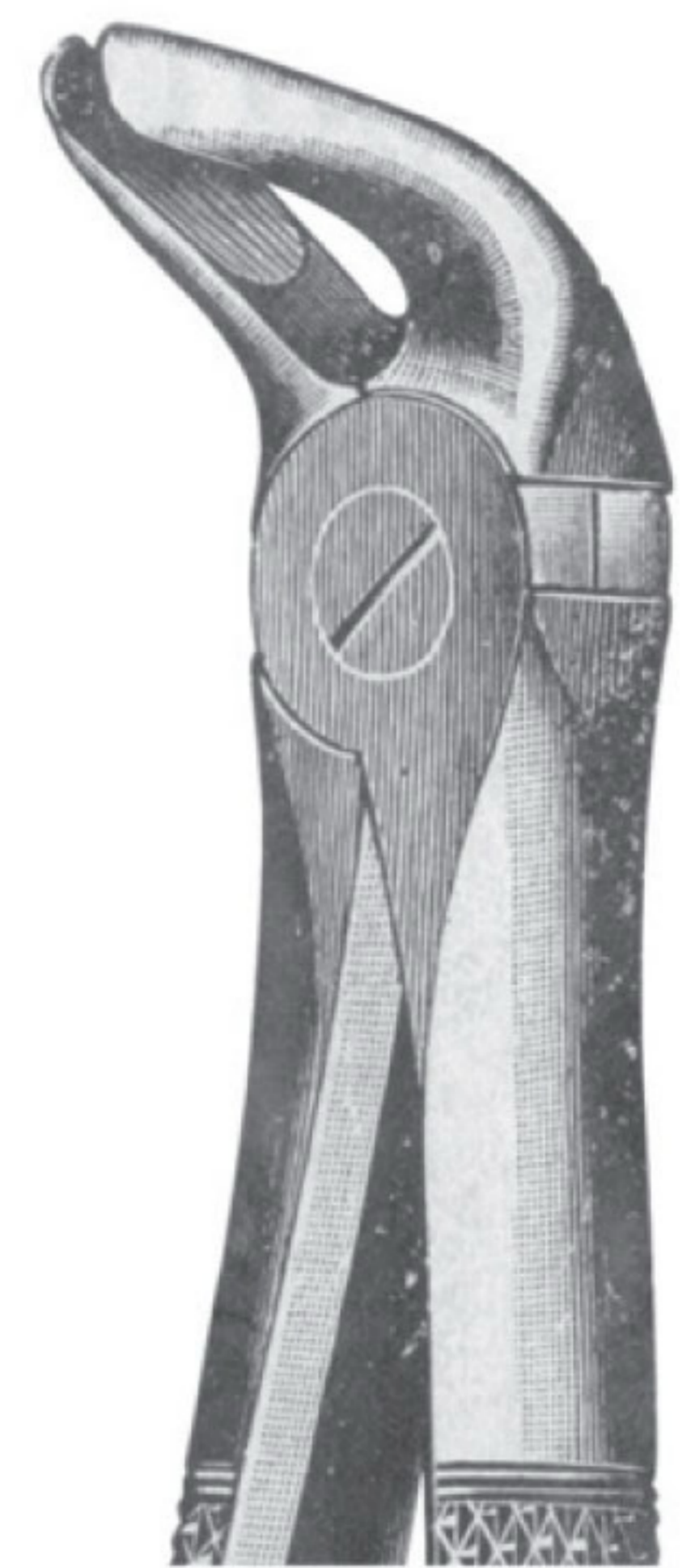

Fig. 12
MWD-1120
Fig. 12

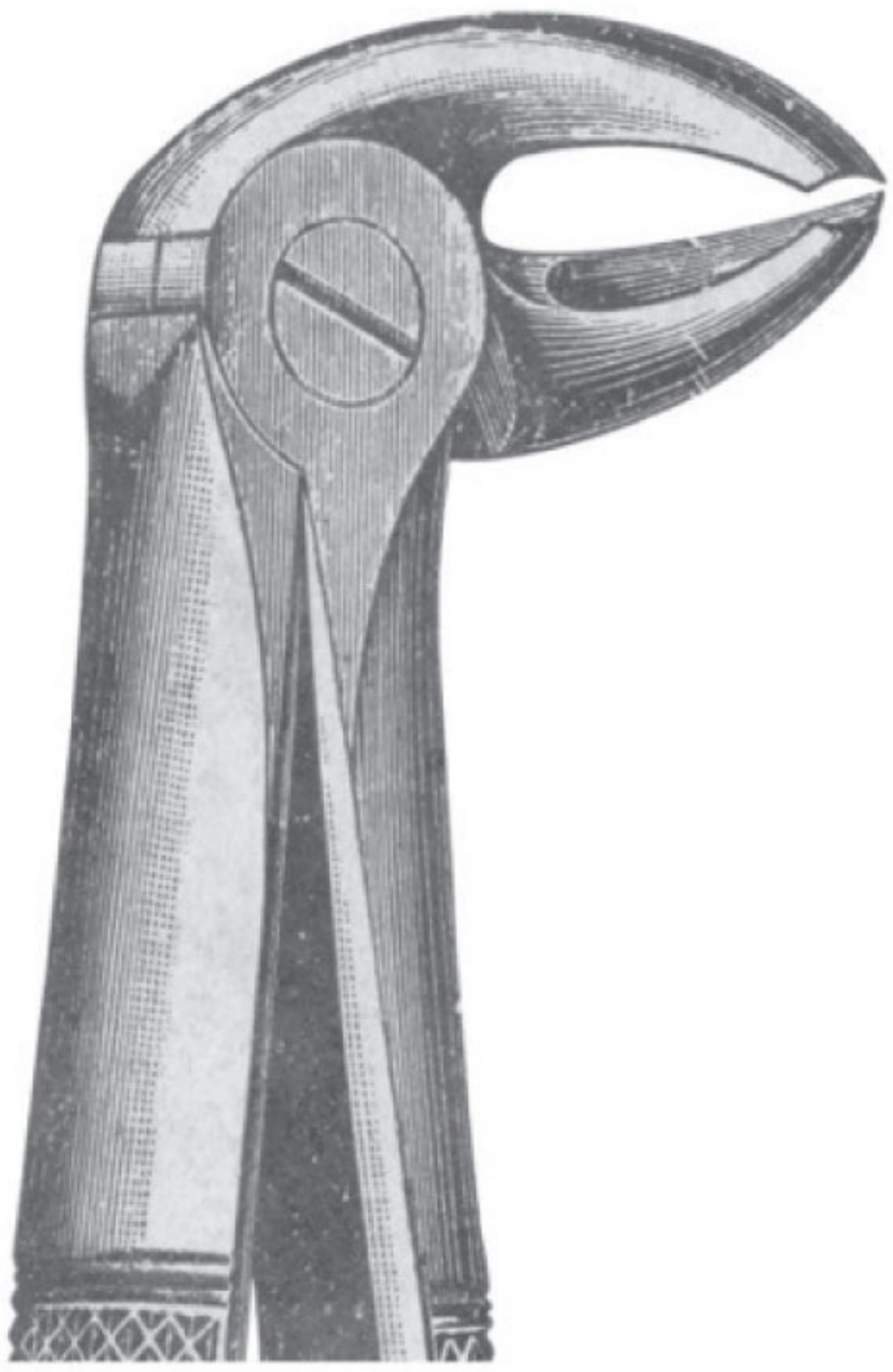

Fig. 14
MWD-1121
Fig. 14

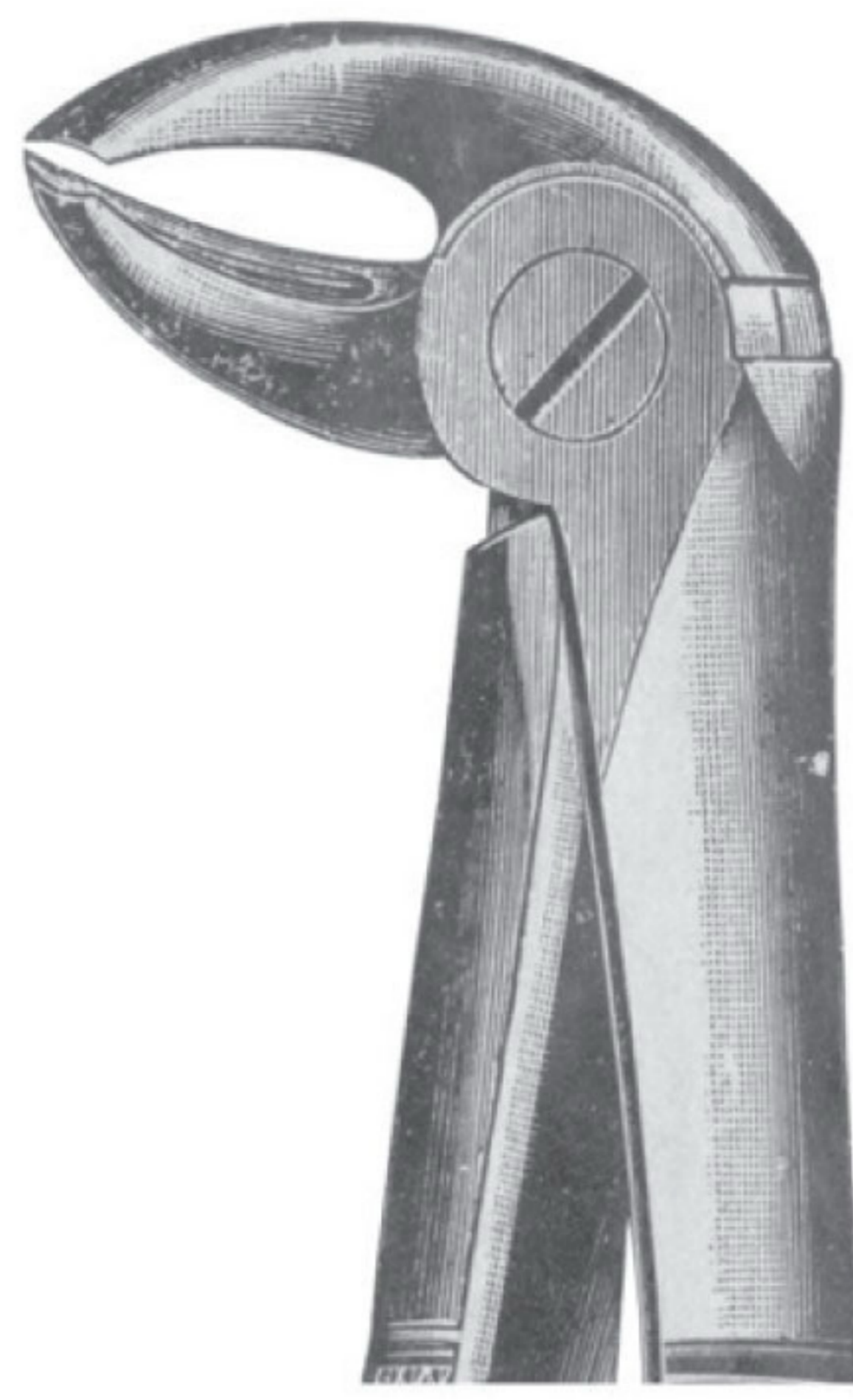

Fig. 15
MWD-1122
Fig. 15



Fig. 25
MWD-1123
Fig. 25

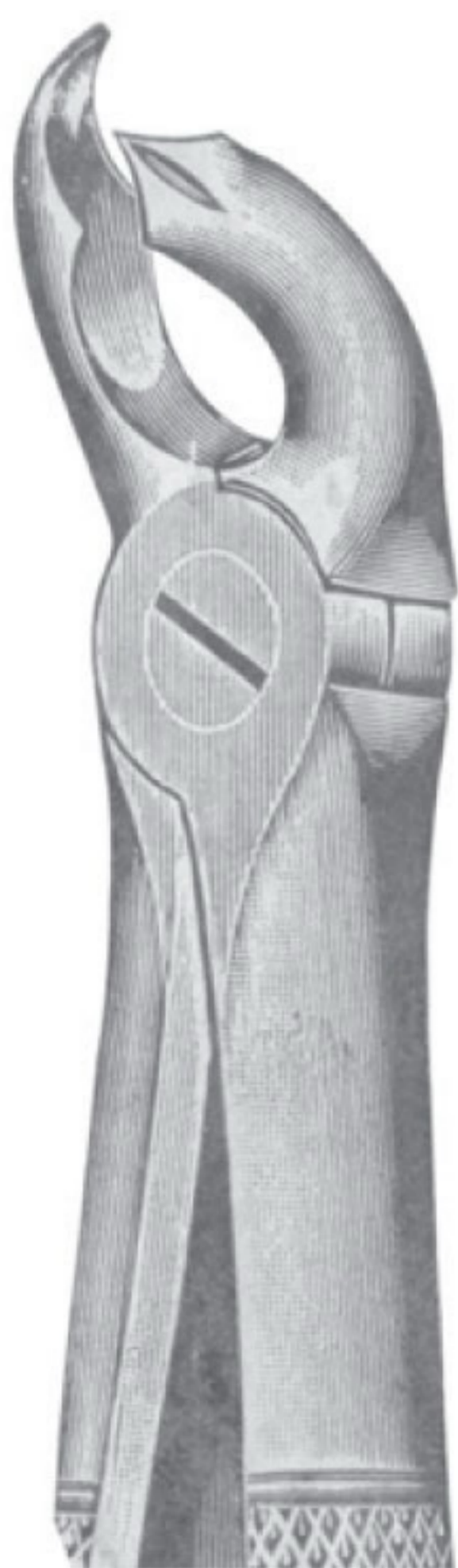

Fig. 26
MWD-1124
Fig. 26

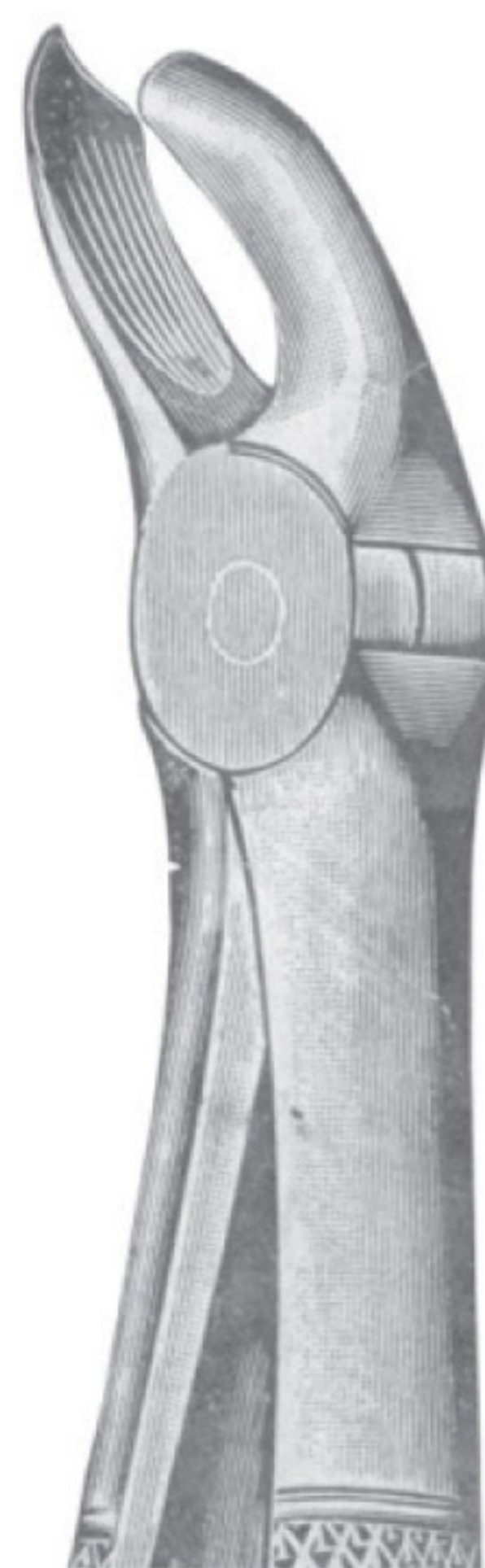

Fig. 27
MWD-1125
Fig. 27

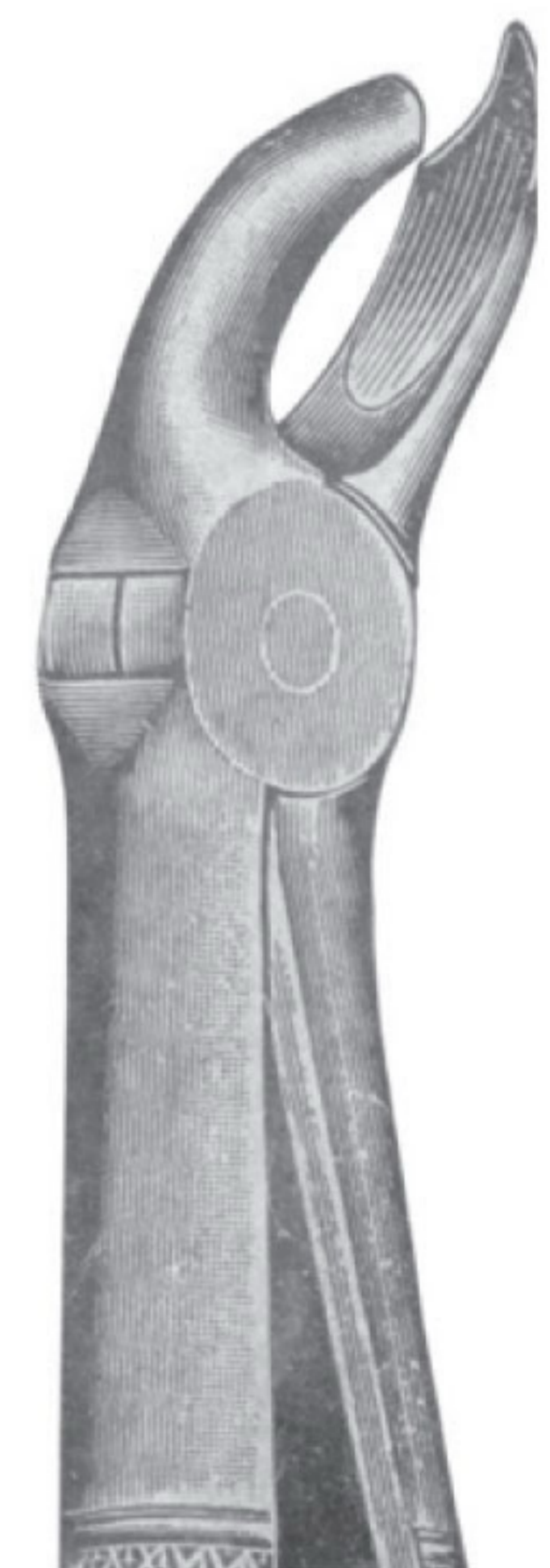

Fig. 28
MWD-1126
Fig. 28

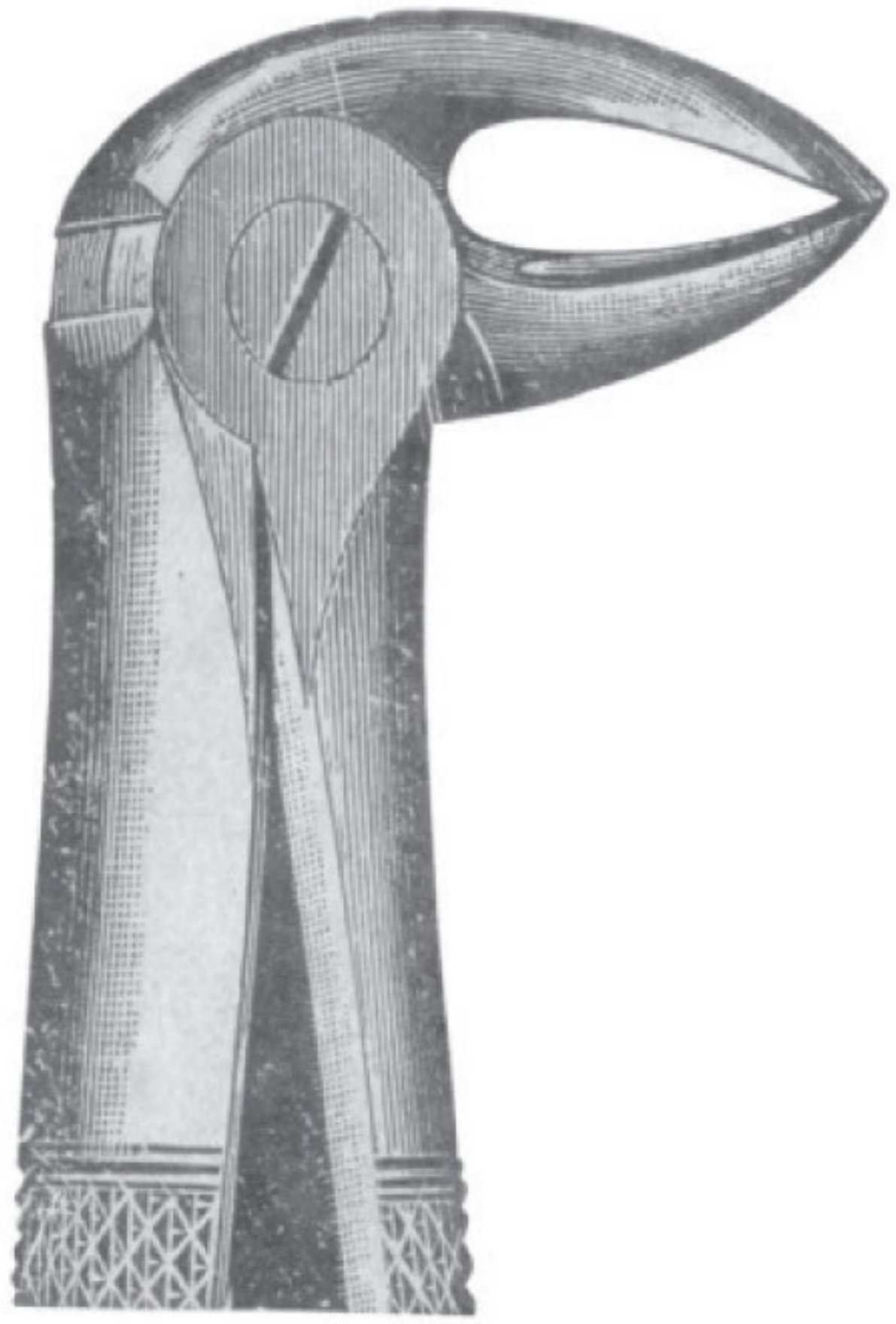

Fig. 34
MWD-1127
Fig. 34

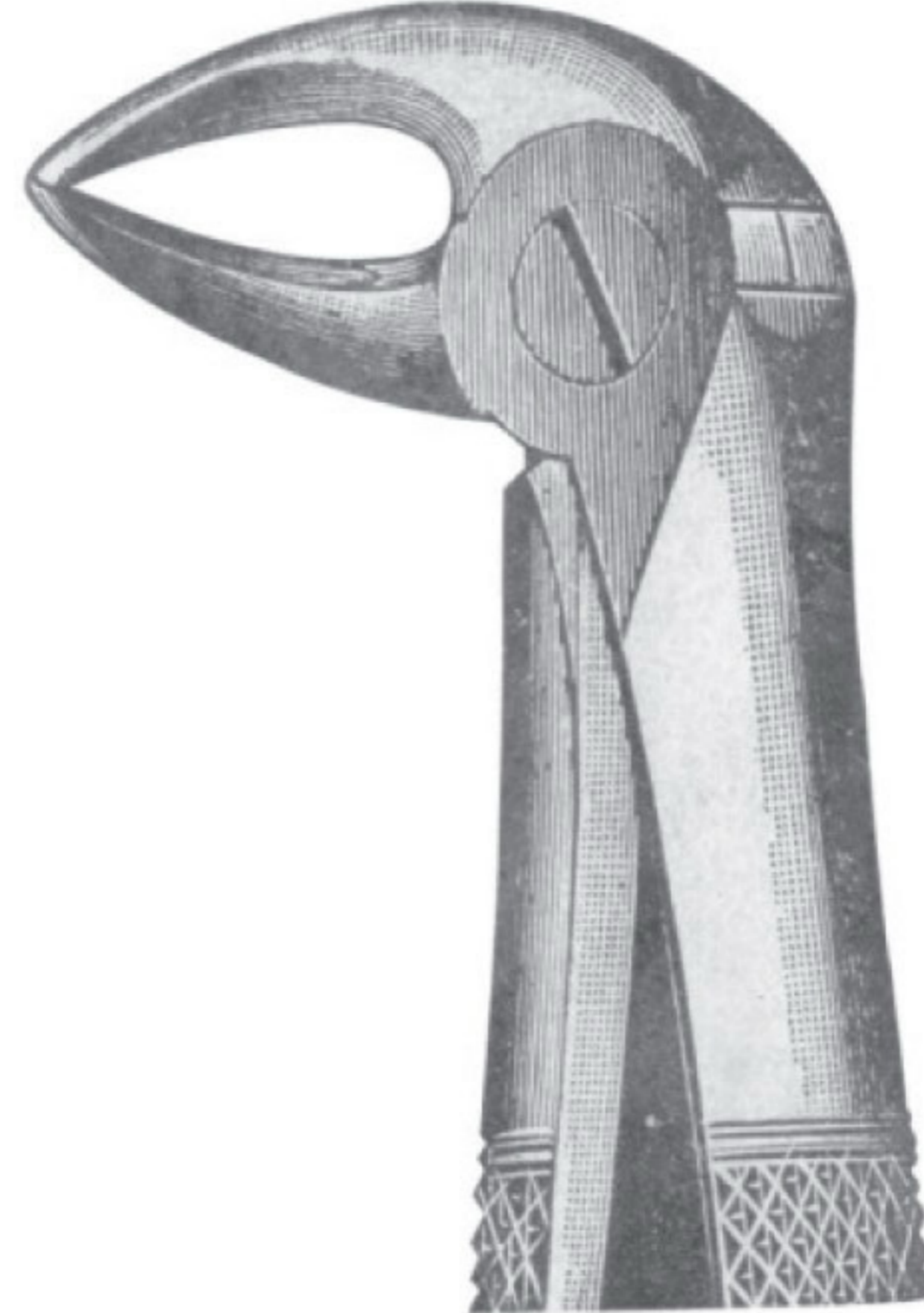

Fig. 35
MWD-1128
Fig. 35

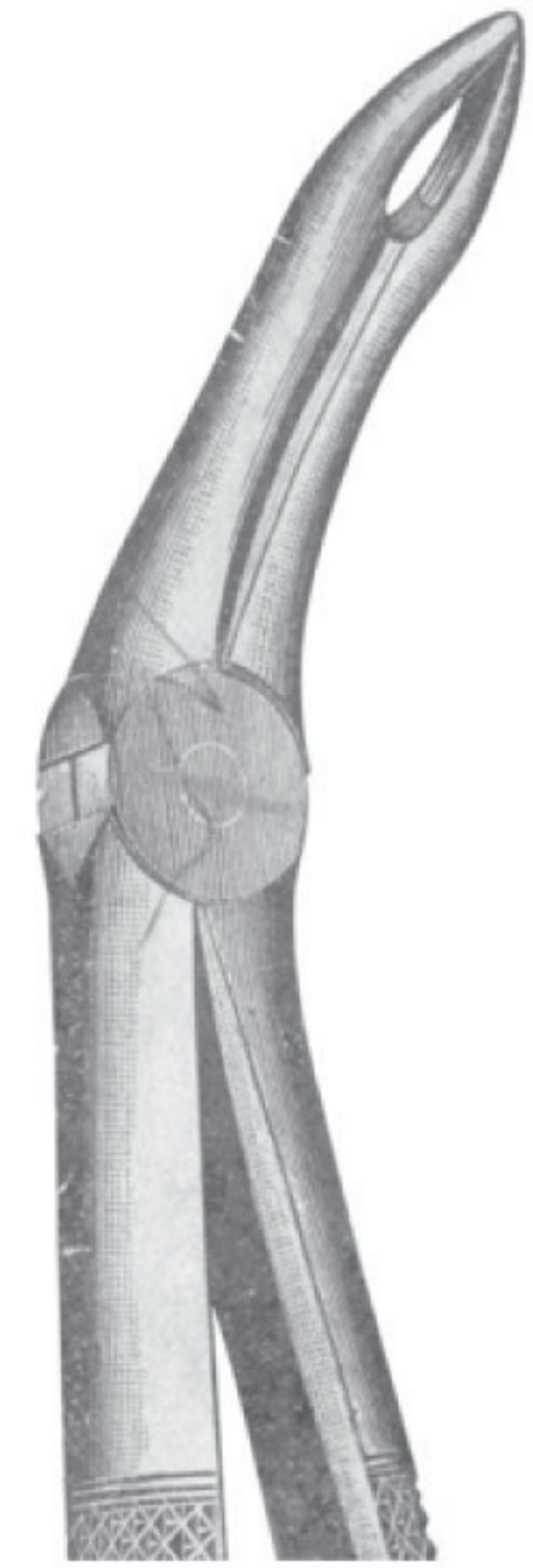

Fig. 42
MWD-1129
Fig. 42

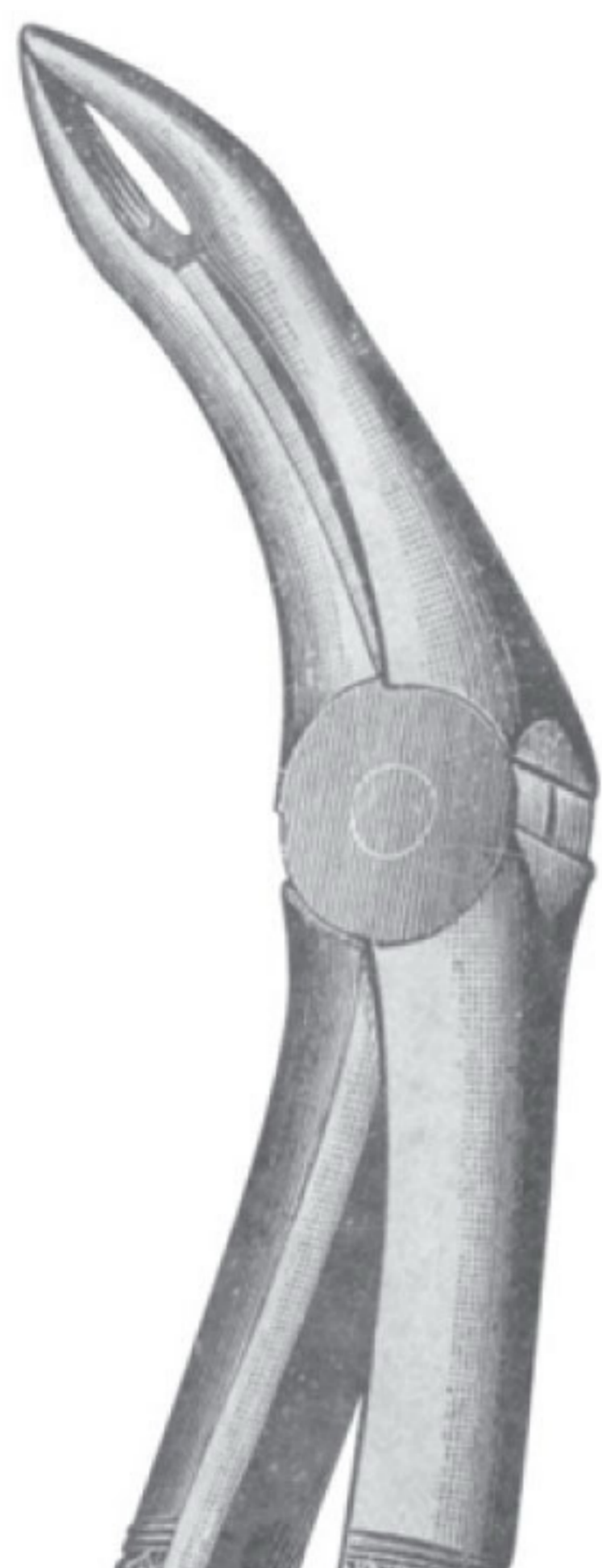

Fig. 43
MWD-1130
Fig. 43

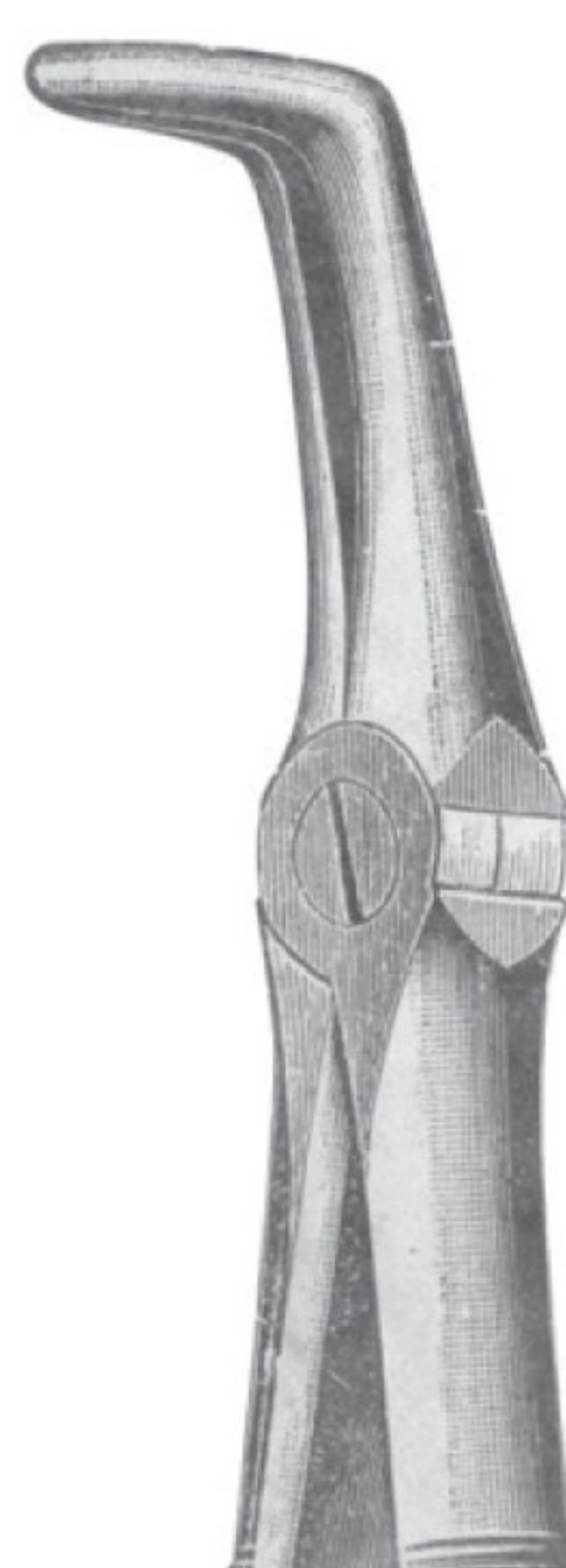

Fig. 44A
MWD-1131
Fig. 44A

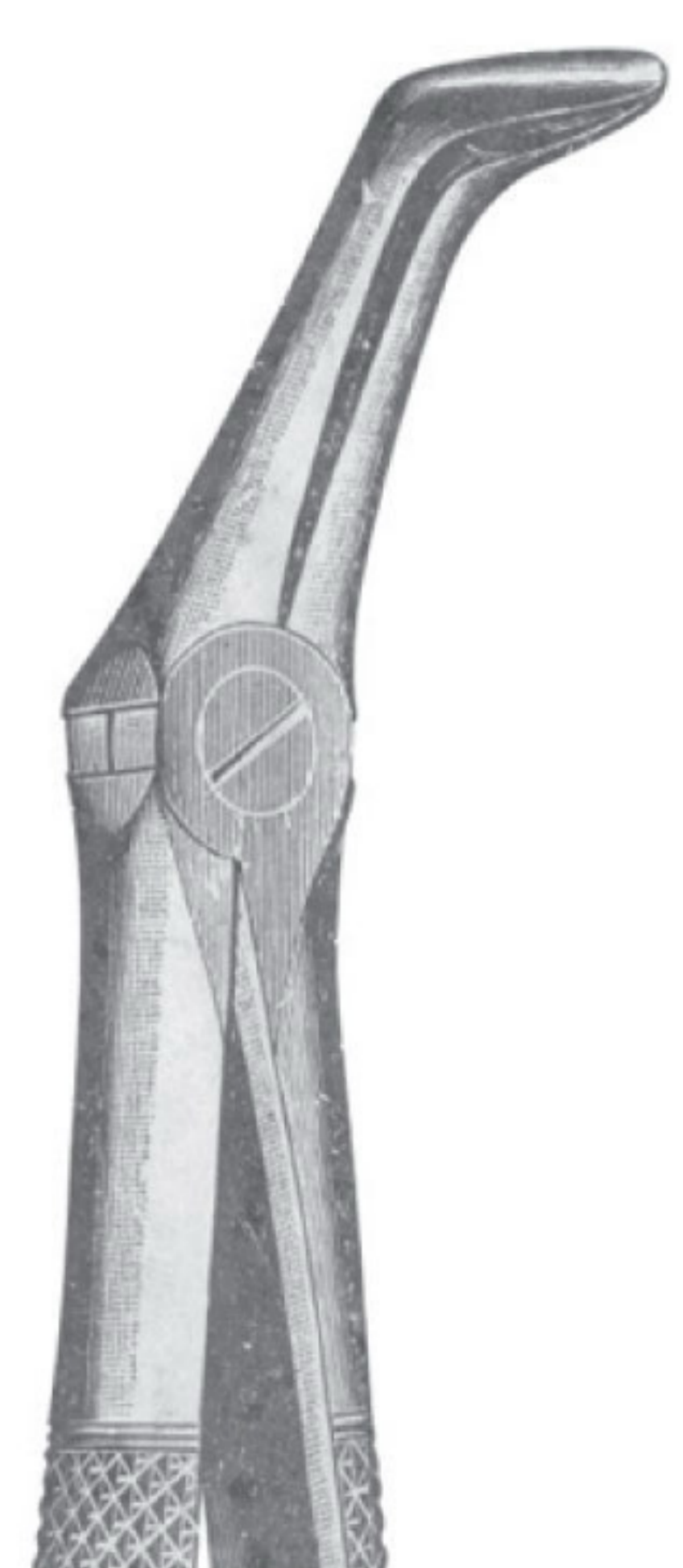

Fig. 46
MWD-1132
Fig. 46

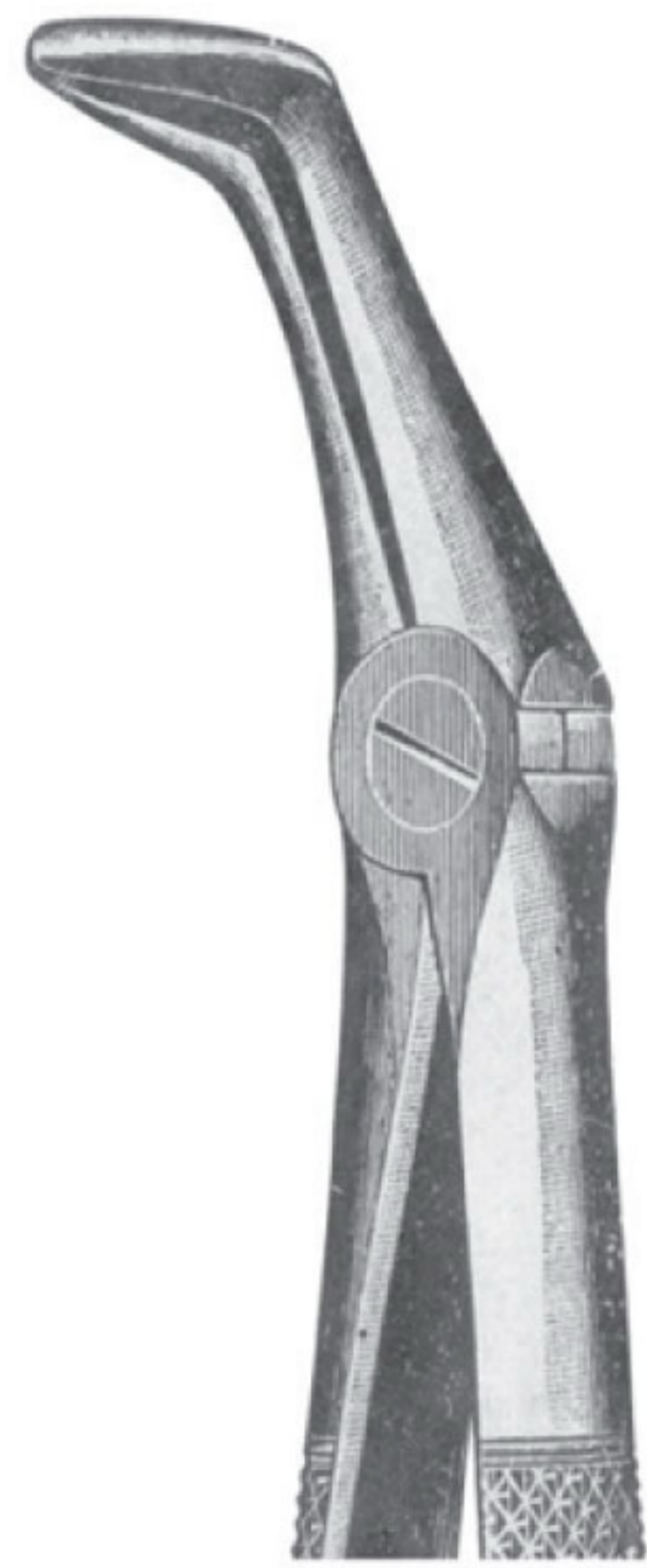

Fig. 47
MWD-1133
Fig. 47

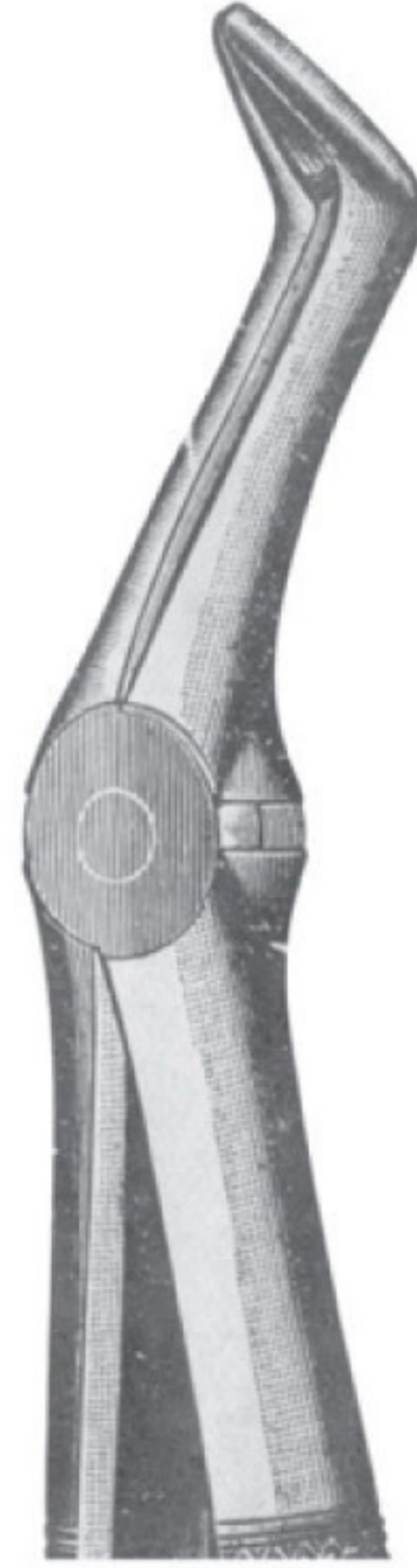

Fig. 50A
MWD-1134
Fig. 50A



Fig. 74R
MWD-1135
Fig. 74R



Fig. 74L
MWD-1136
Fig. 74L



Fig. 75R
MWD-1137
Fig. 75R



Fig. 75L
MWD-1138
Fig. 75L

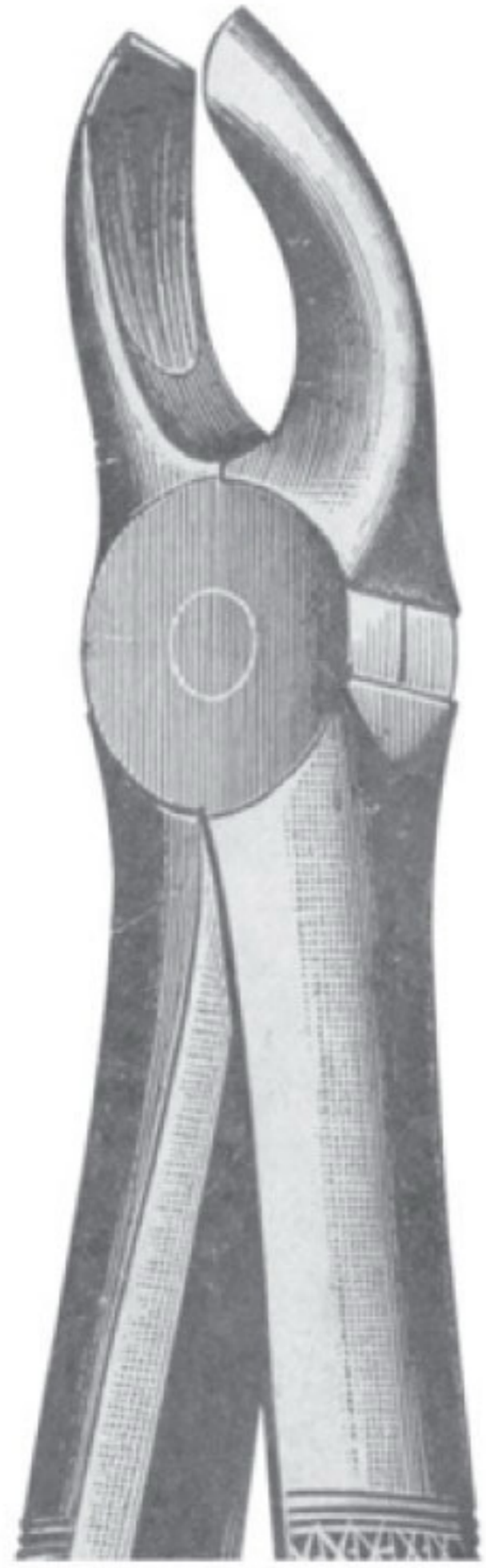

Fig. 94
MWD-1139
Fig. 94

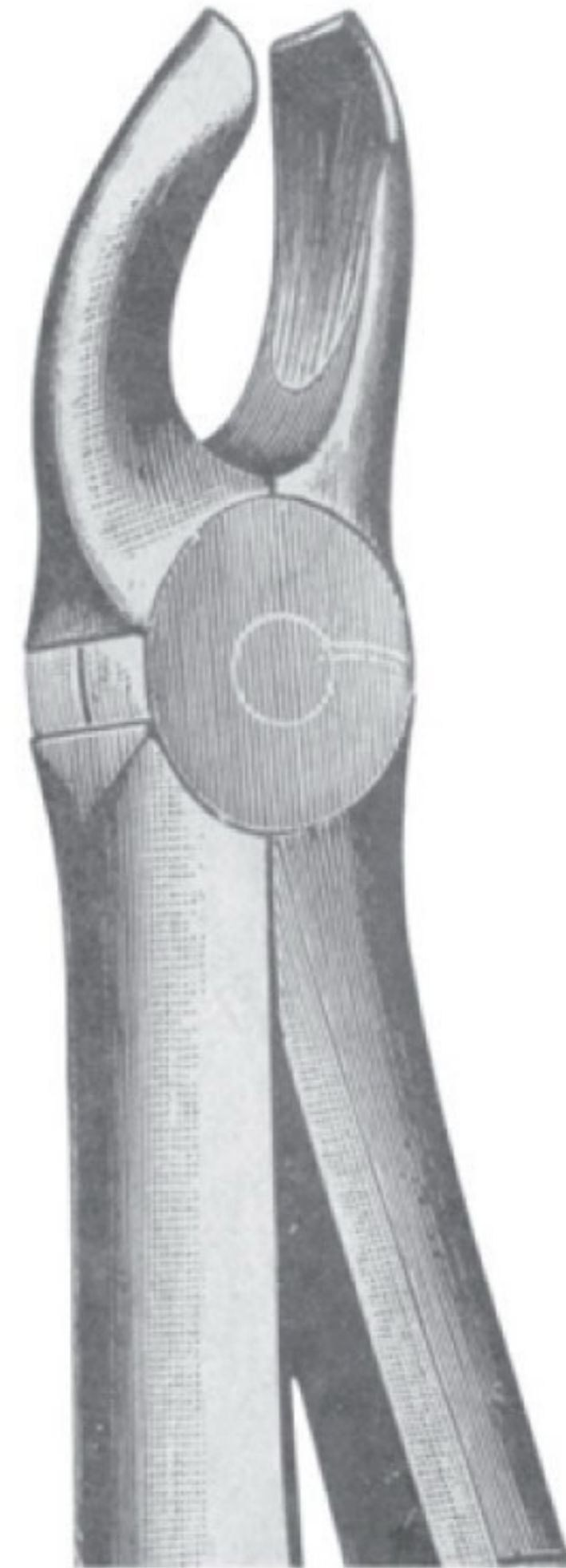

Fig. 95
MWD-1140
Fig. 95

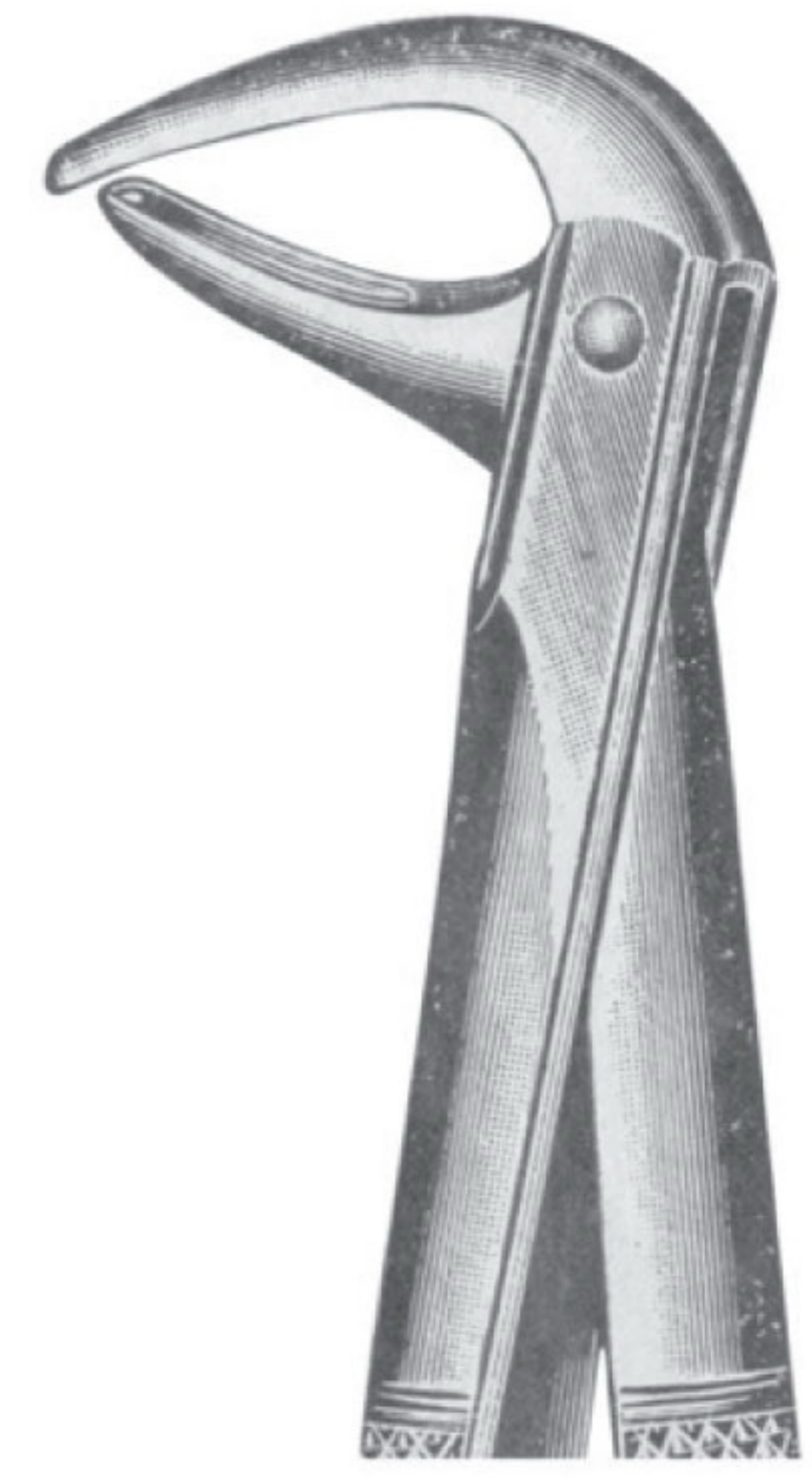

Fig. 98
MWD-1141
Fig. 98



Fig. 105
MWD-1142
Fig. 105



Fig. 106
MWD-1143
Fig. 106



Fig. 1 upper laterals and canines
MWD-1145
Fig. 1 upper laterals and canines

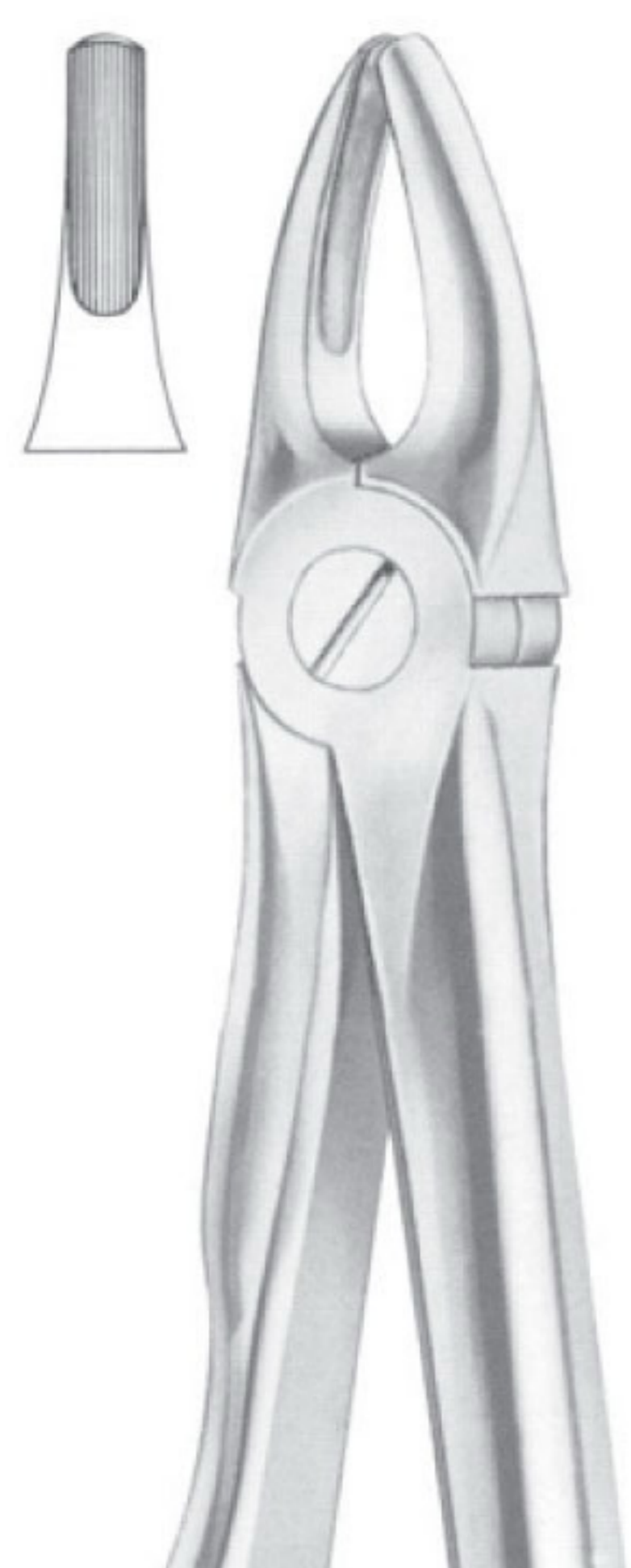

Fig. 2 upper laterals and canines
MWD-1146

Fig. 2 upper laterals and canines



Fig. 3 upper incisors and canines
MWD-1147

Fig. 3 upper incisors and canines

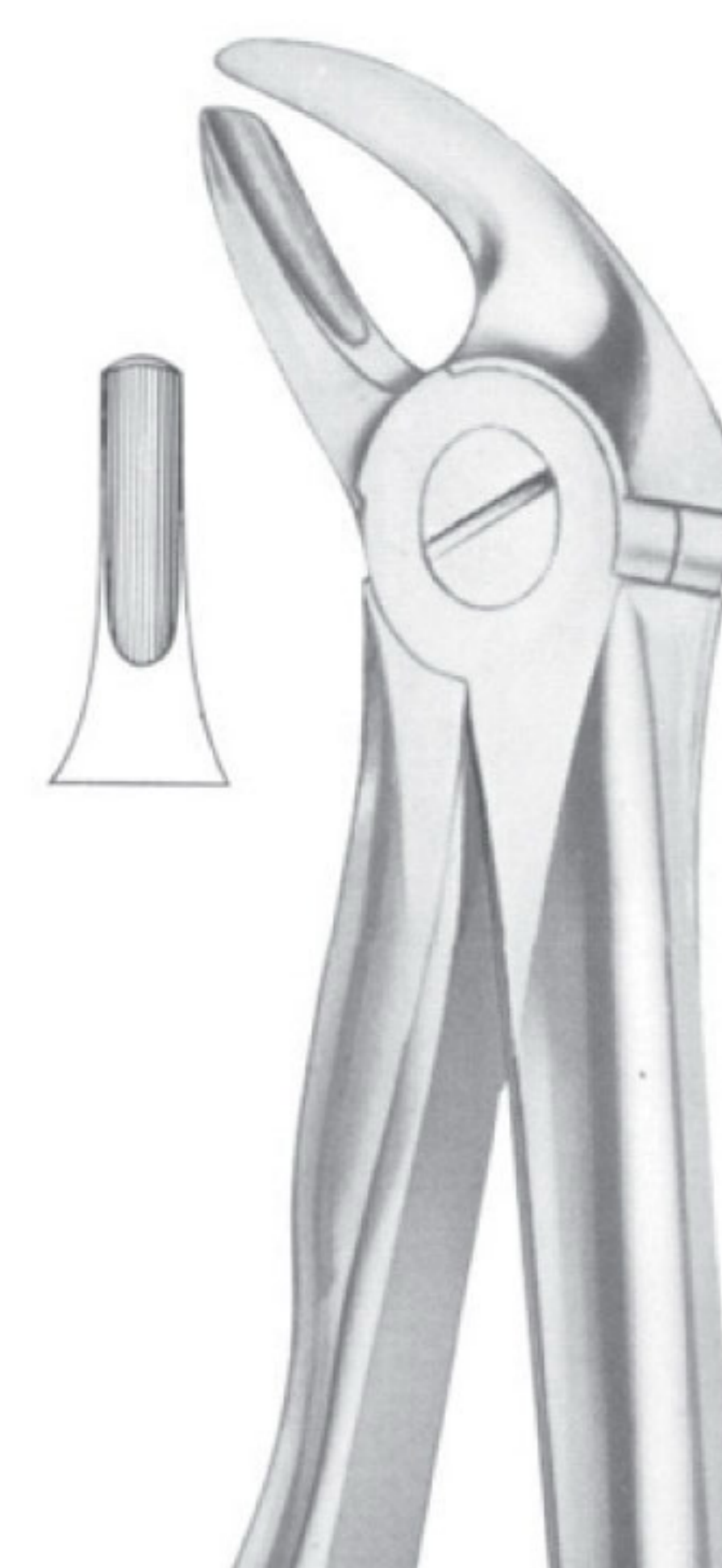

Fig. 4 lower incisors and canines
MWD-1148

Fig. 4 lower incisors and canines

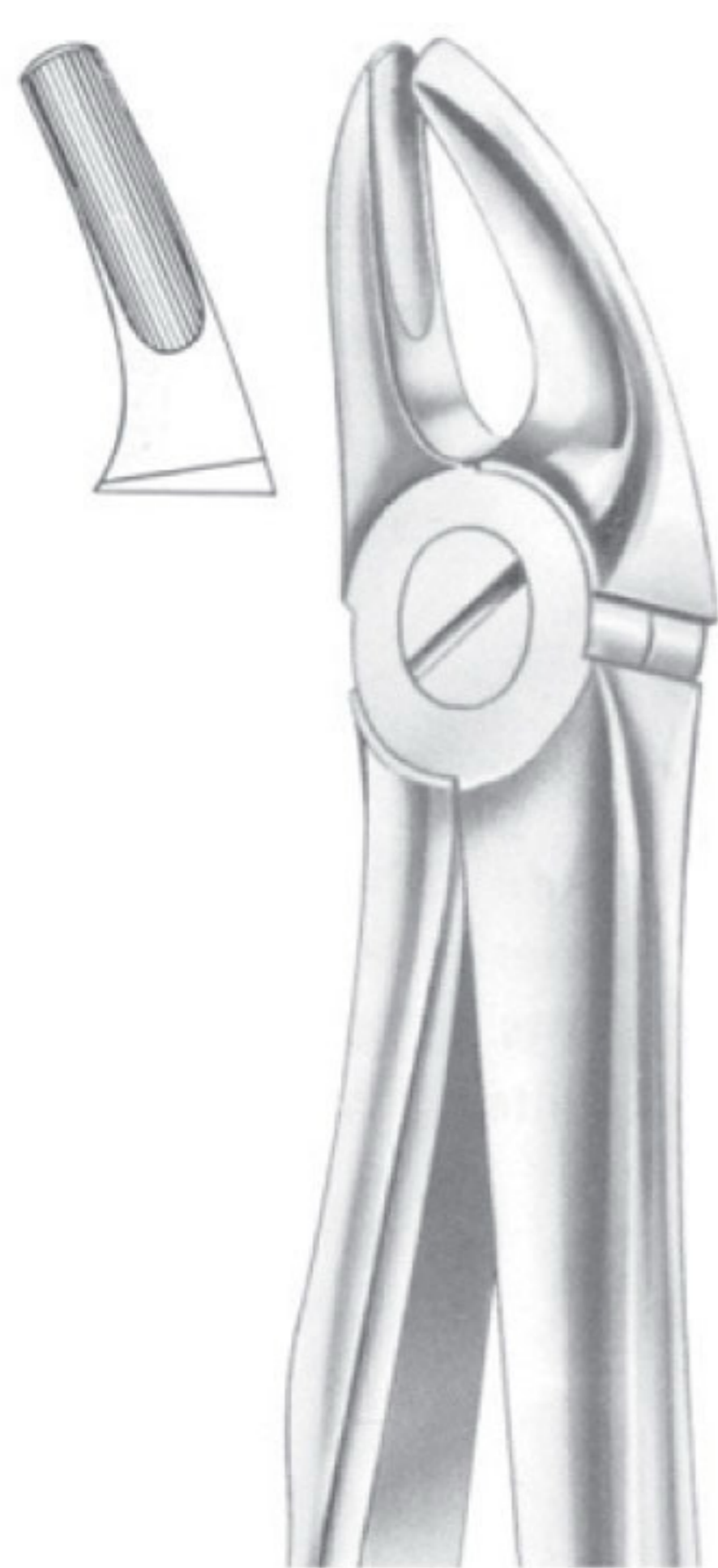

Fig. 7 upper premolars
MWD-1149

Fig. 7 upper premolars

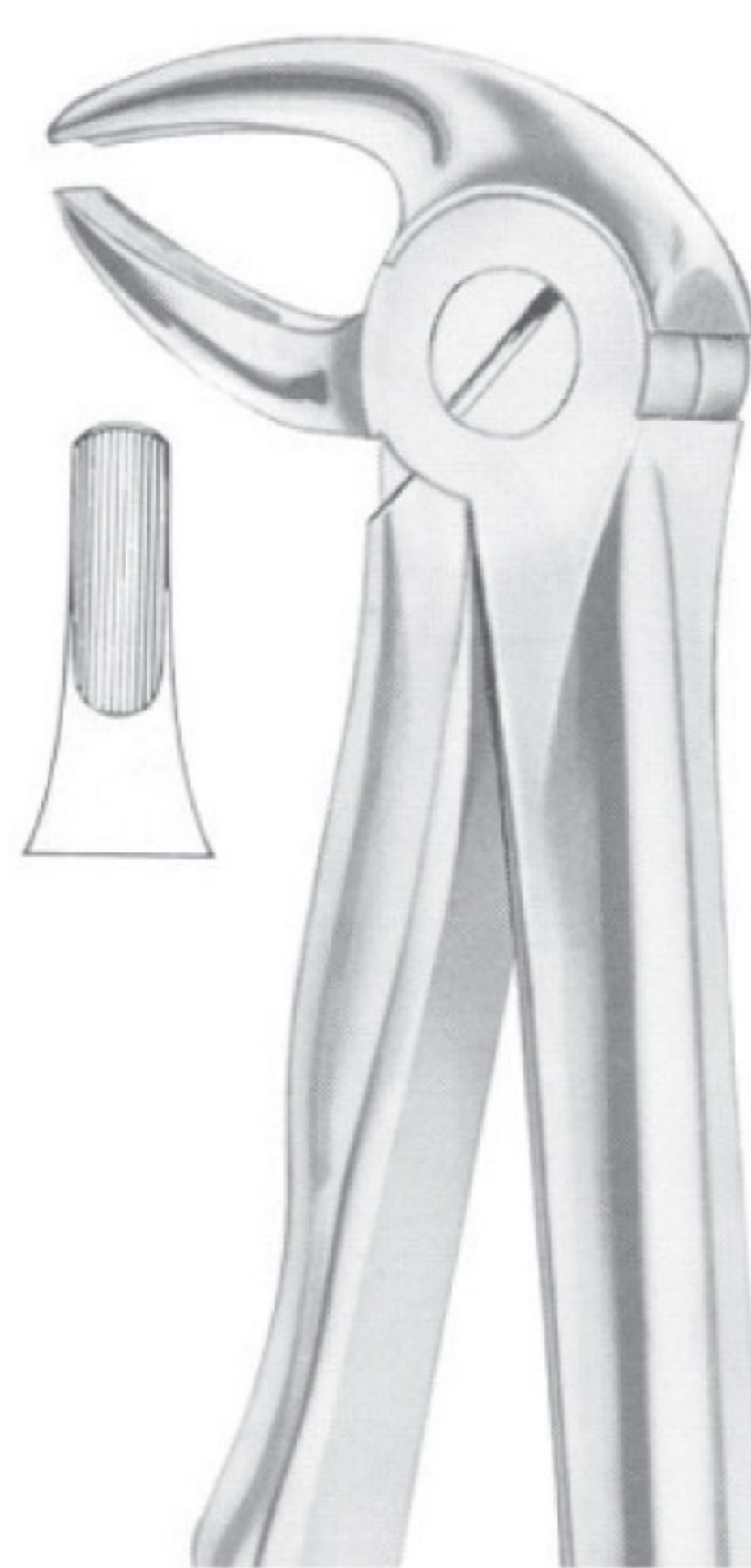

Fig. 13 lower premolars
MWD-1150

Fig. 13 lower premolars

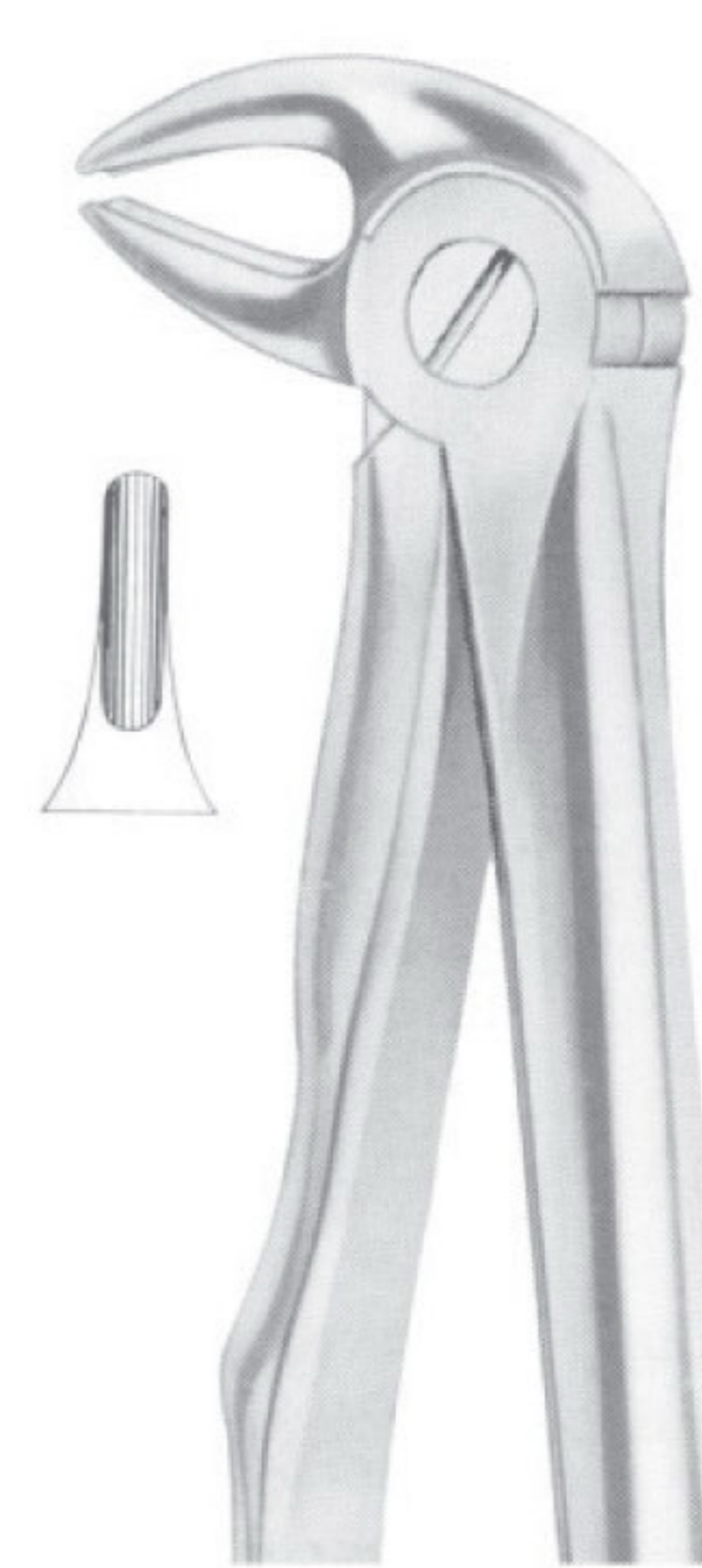

Fig. 13S lower premolars for children
MWD-1151

Fig. 13S lower premolars for children



**Fig. 17 upper molars right
MWD-1152**
Fig. 17 upper molars right



**Fig. 18 upper molars left
MWD-1153**
Fig. 18 upper molars left



**Fig. 18A upper molars
MWD-1154**
Fig. 18A upper molars

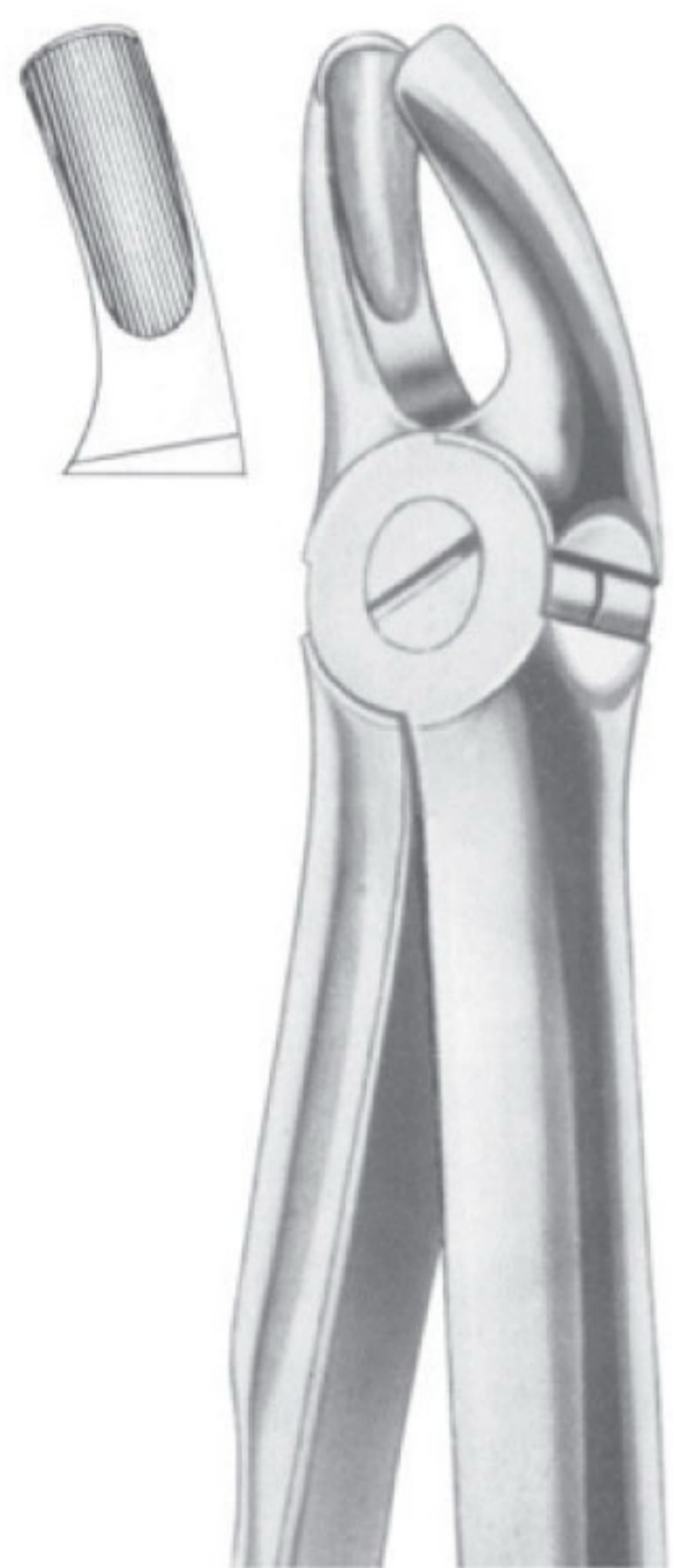

**Fig. 18B upper molars
MWD-1155**
Fig. 18B upper molars



**Fig. 19 upper third molars
MWD-1156**
Fig. 19 upper third molars

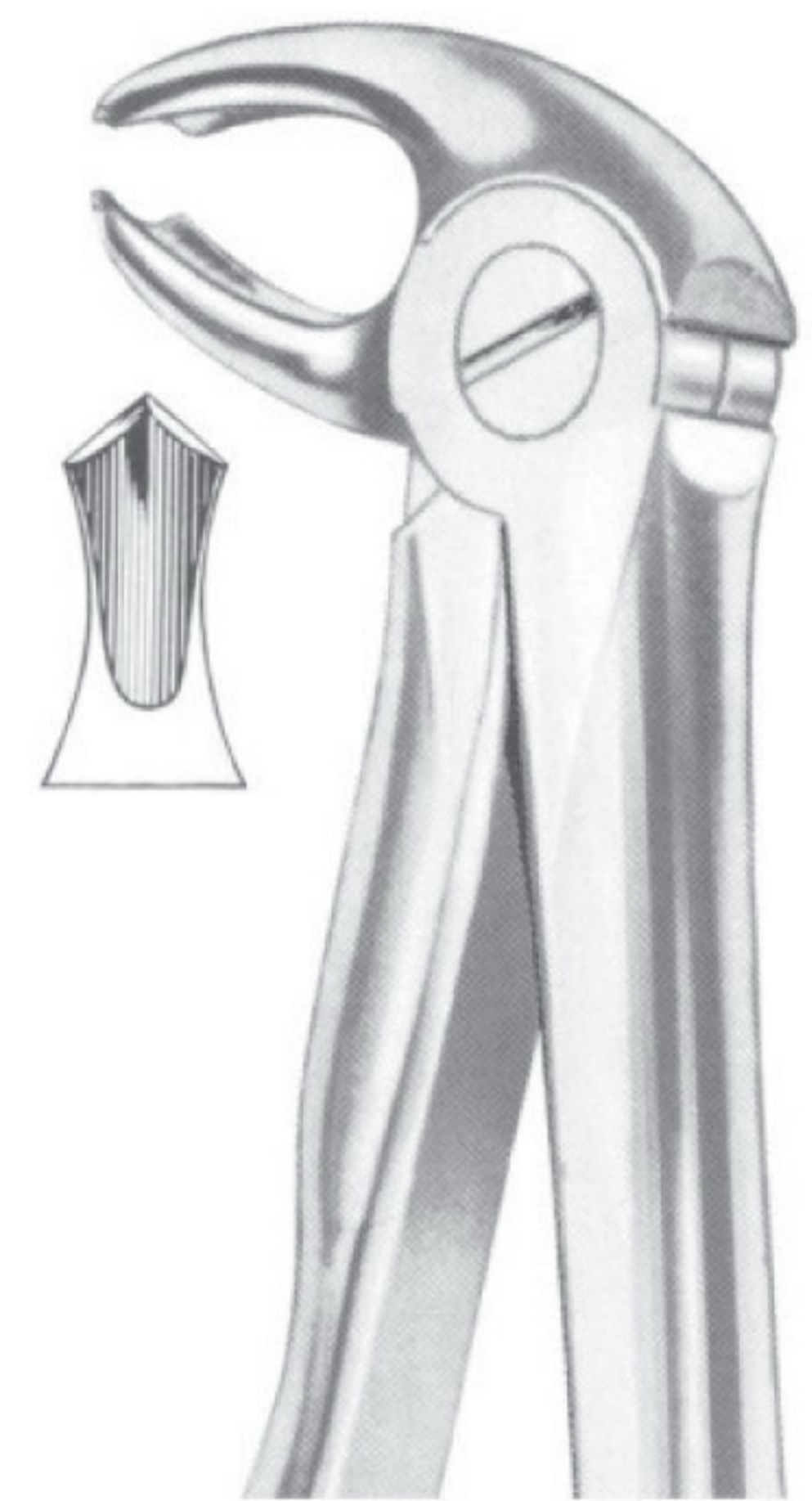

**Fig. 22 lower molars
MWD-1157**
Fig. 22 lower molars

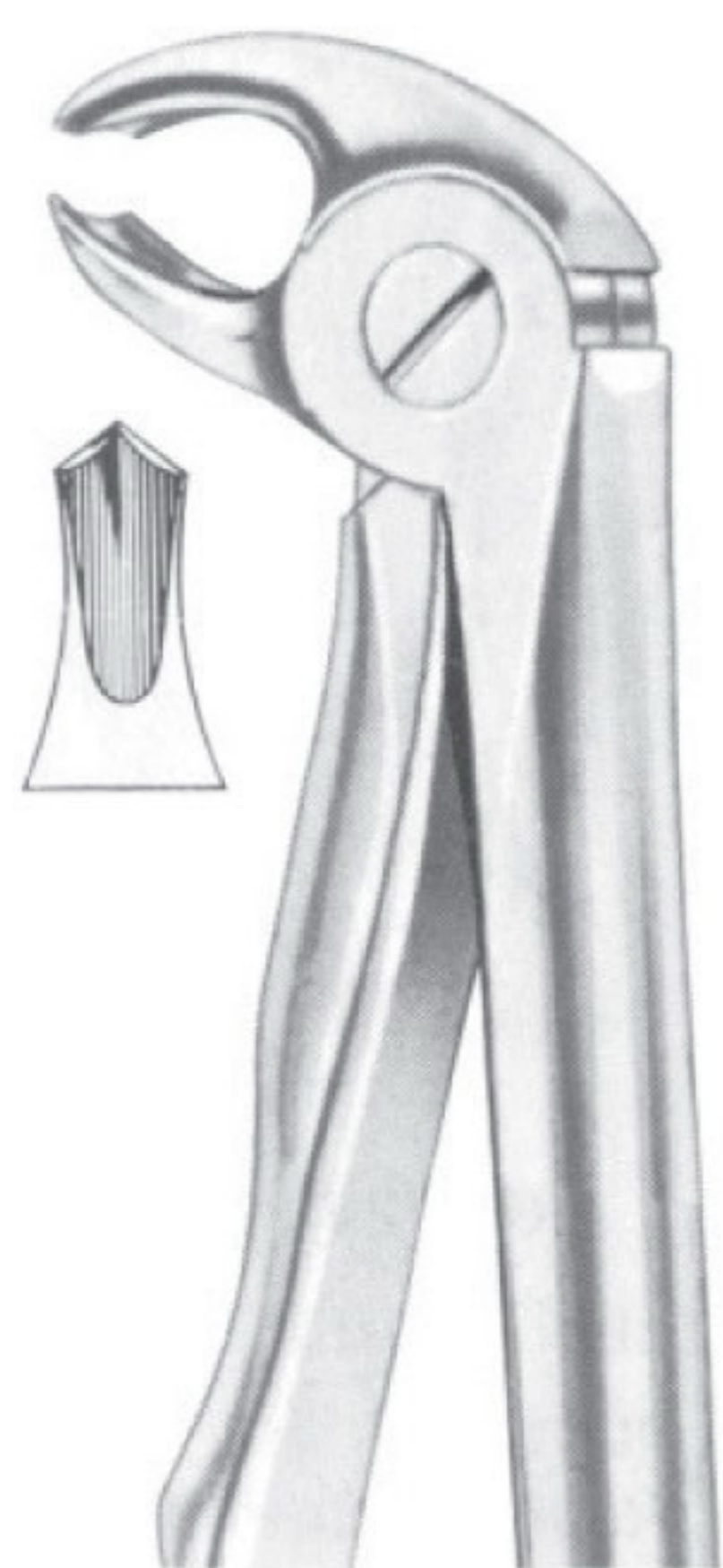

Fig. 22S lower molars for children
MWD-1158
 Fig. 22S lower molars for children



Fig. 29 upper roots
MWD-1159
 Fig. 29 upper roots

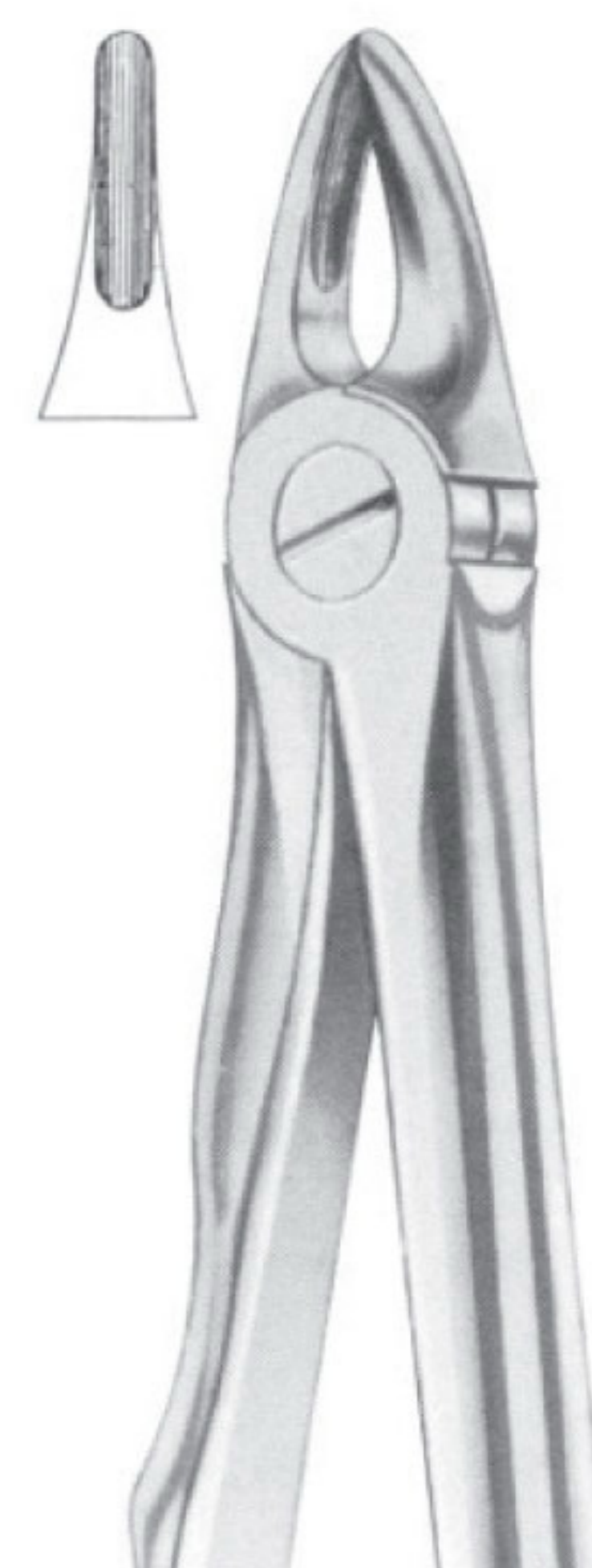

Fig. 29S upper roots for children
MWD-1160
 Fig. 29S upper roots for children

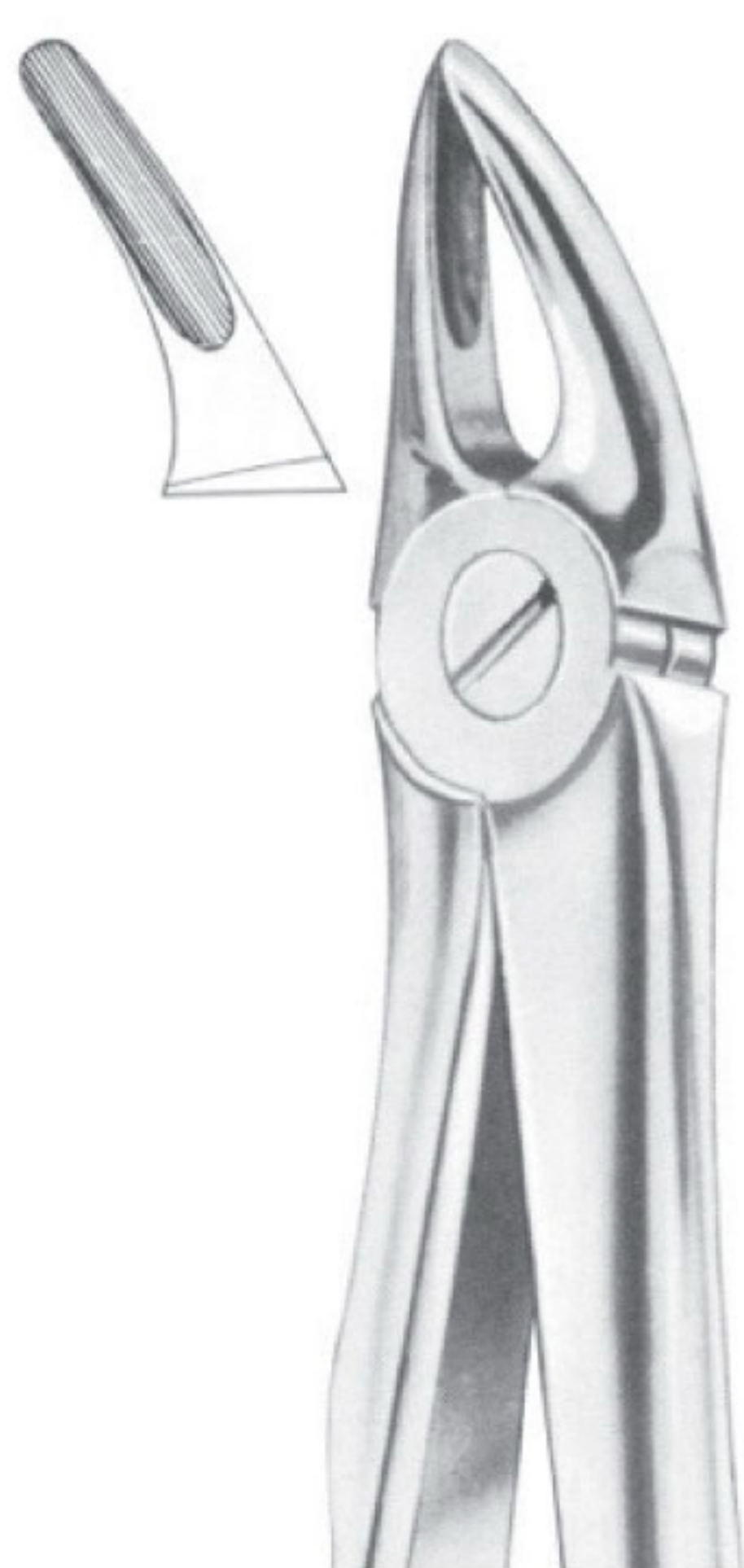

Fig. 30 upper roots
MWD-1161
 Fig. 30 upper roots

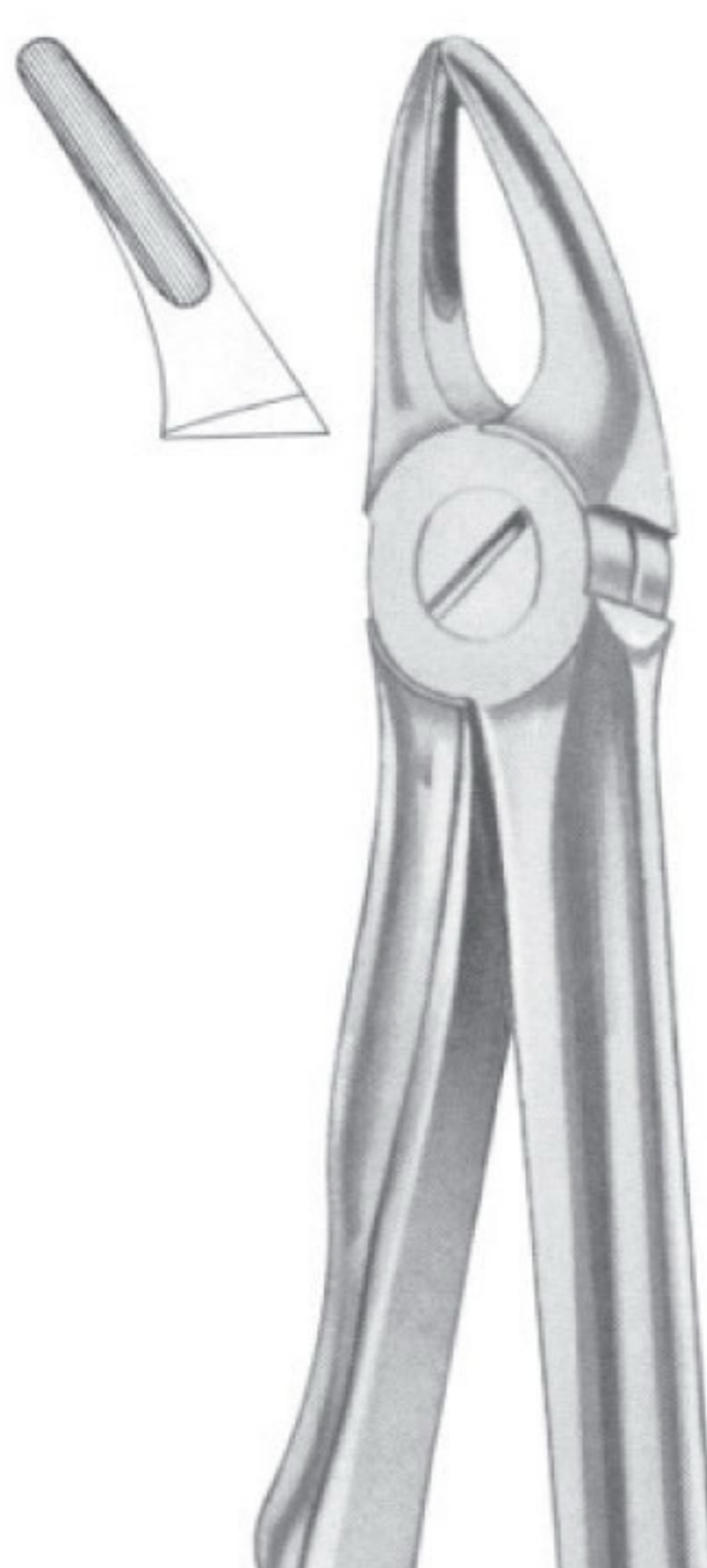

Fig. 30S upper roots for children
MWD-1162
 Fig. 30S upper roots for children

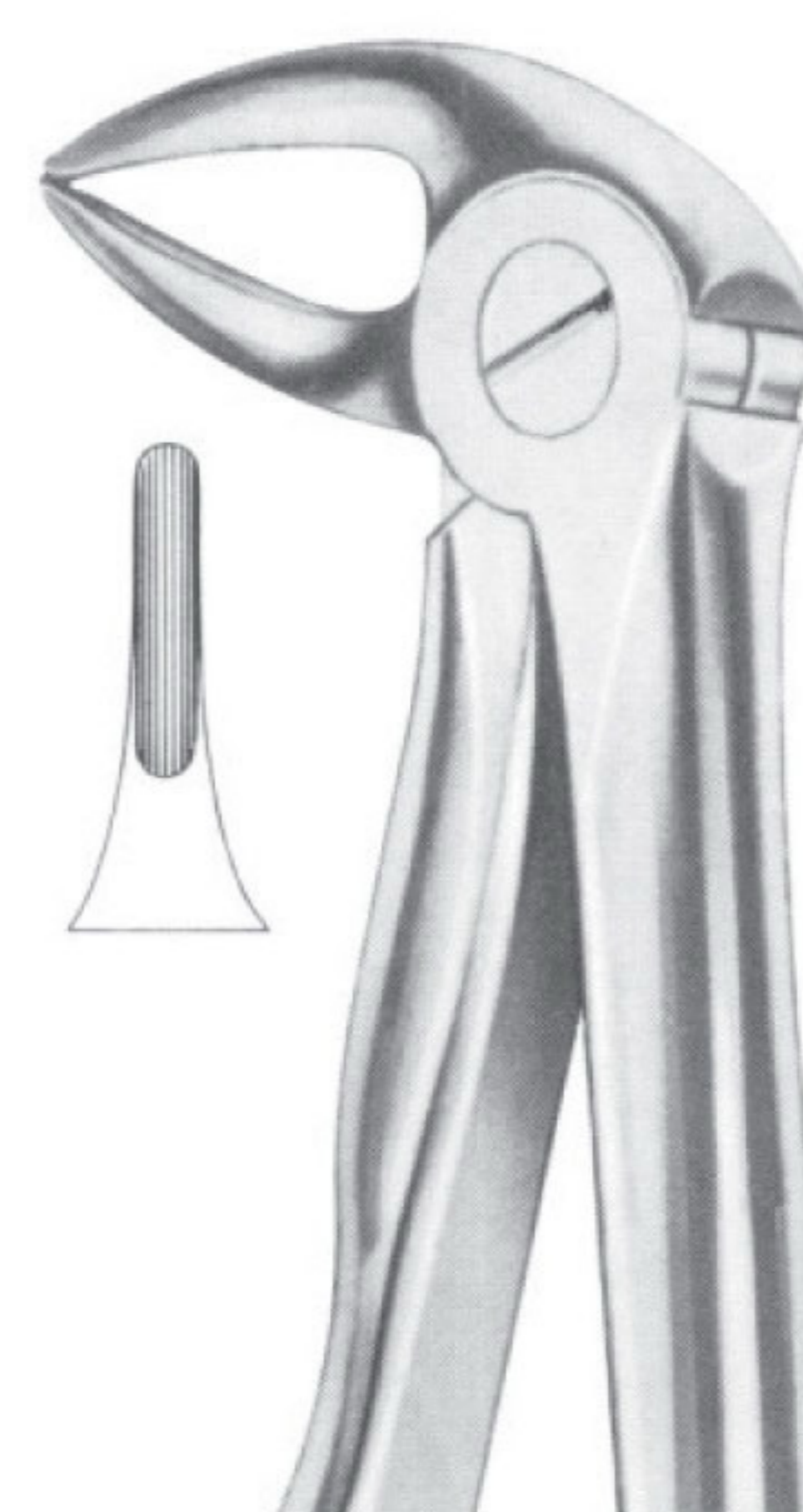

Fig. 33 lower roots
MWD-1163
 Fig. 33 lower roots

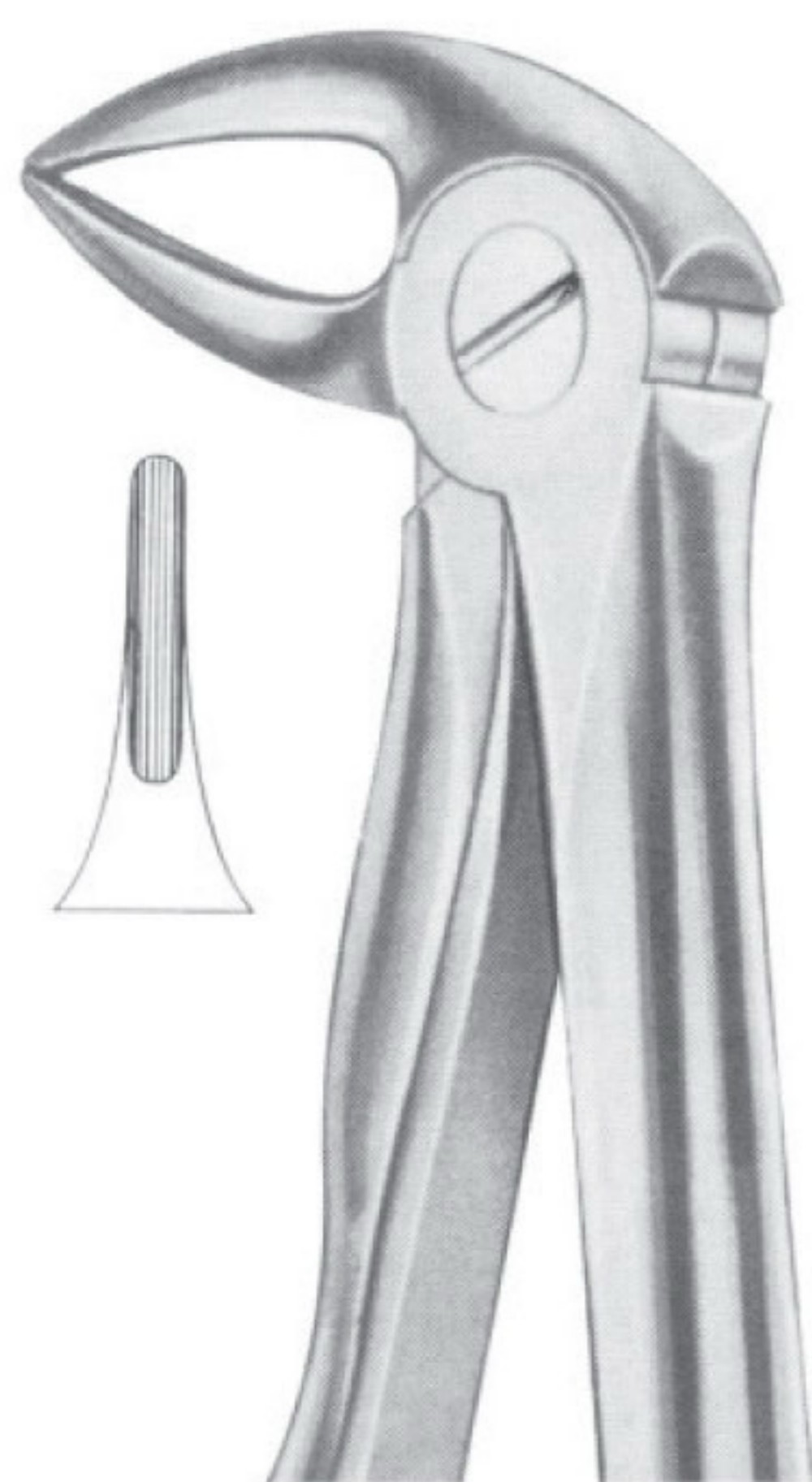

Fig. 33A lower roots
MWD-1164
 Fig. 33A lower roots

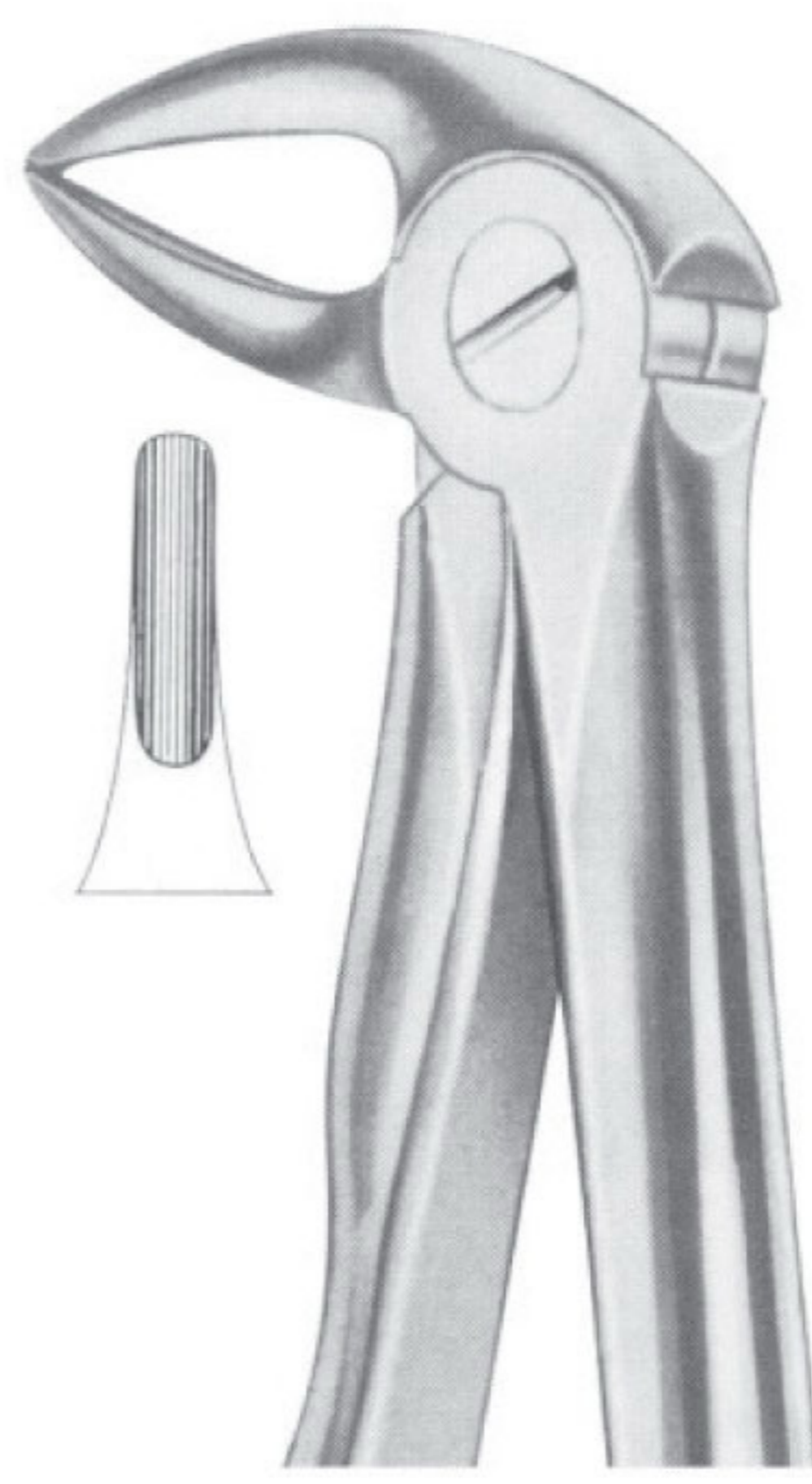

Fig. 33B lower roots
MWD-1165
 Fig. 33B lower roots



Fig. 33L lower roots
MWD-1166
 Fig. 33L lower roots

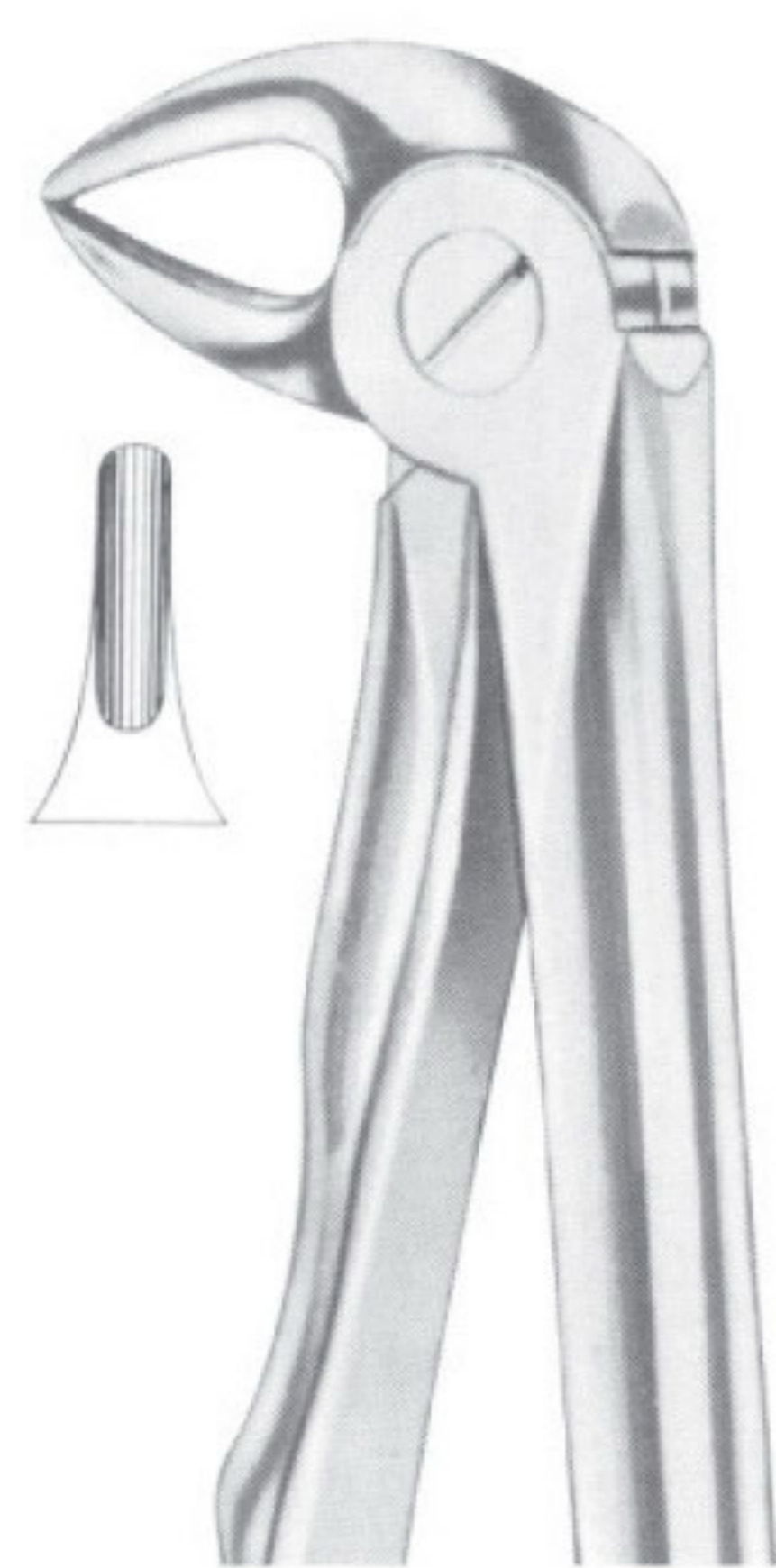

Fig. 33S lower roots for children
MWD-1167
 Fig. 33S lower roots for children

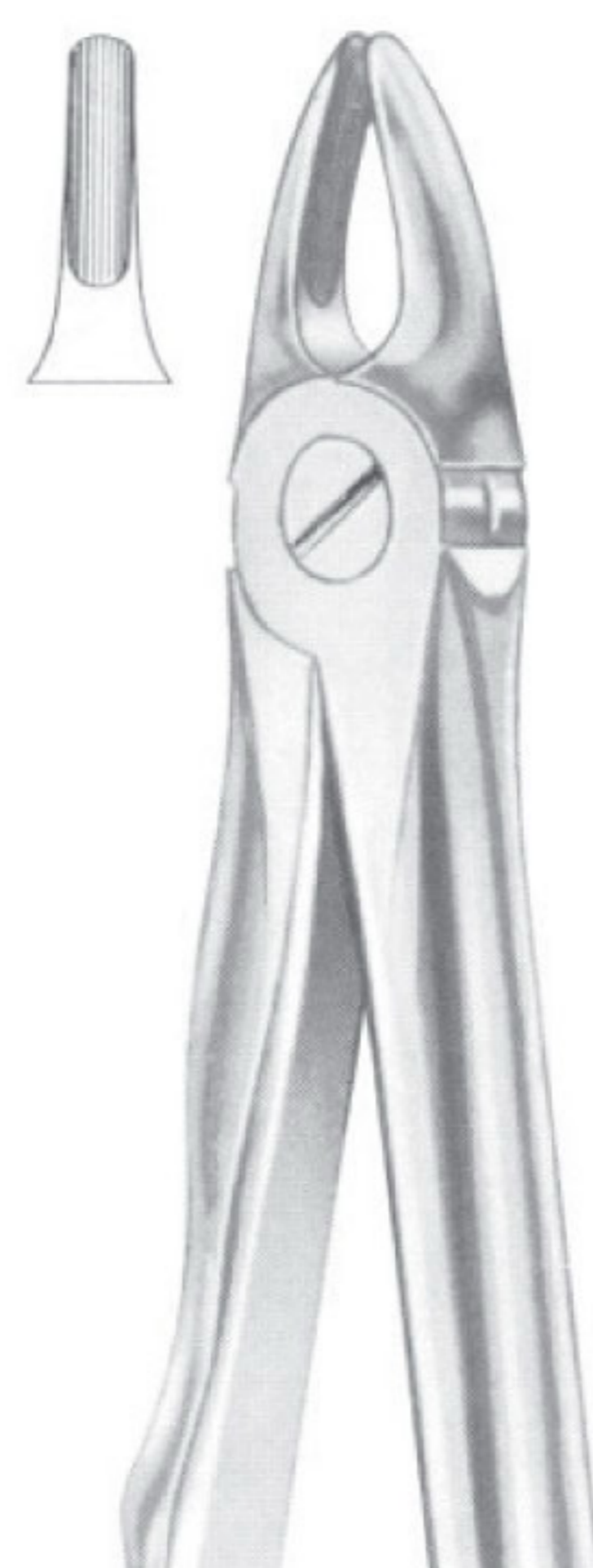

Fig. 37 upper incisors for children
MWD-1168
 Fig. 37 upper incisors for children

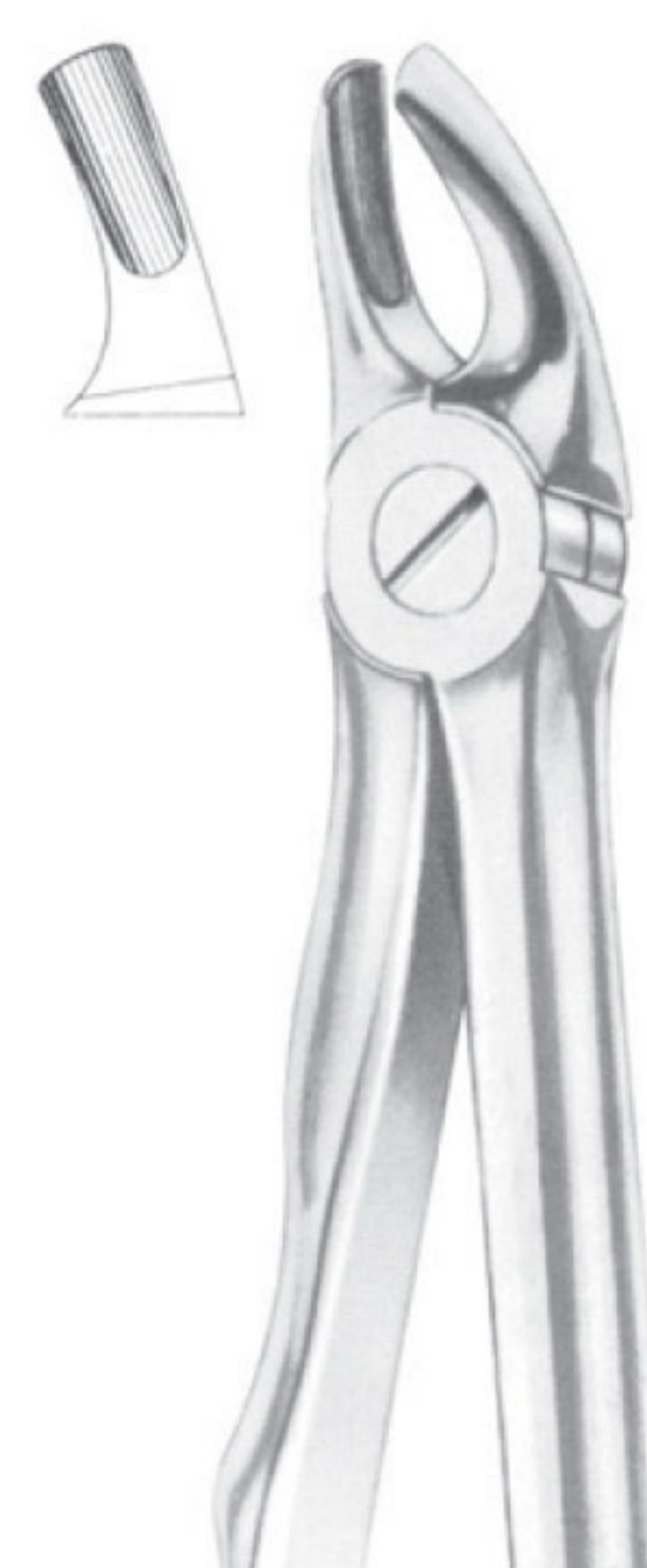

Fig. 39 upper incisors for children
MWD-1169
 Fig. 39 upper incisors for children



Fig. 39A upper molars for children
MWD-1170

Fig. 39A upper molars for children



Fig. 39R upper molars right for children
MWD-1171

Fig. 39R upper molars right for children

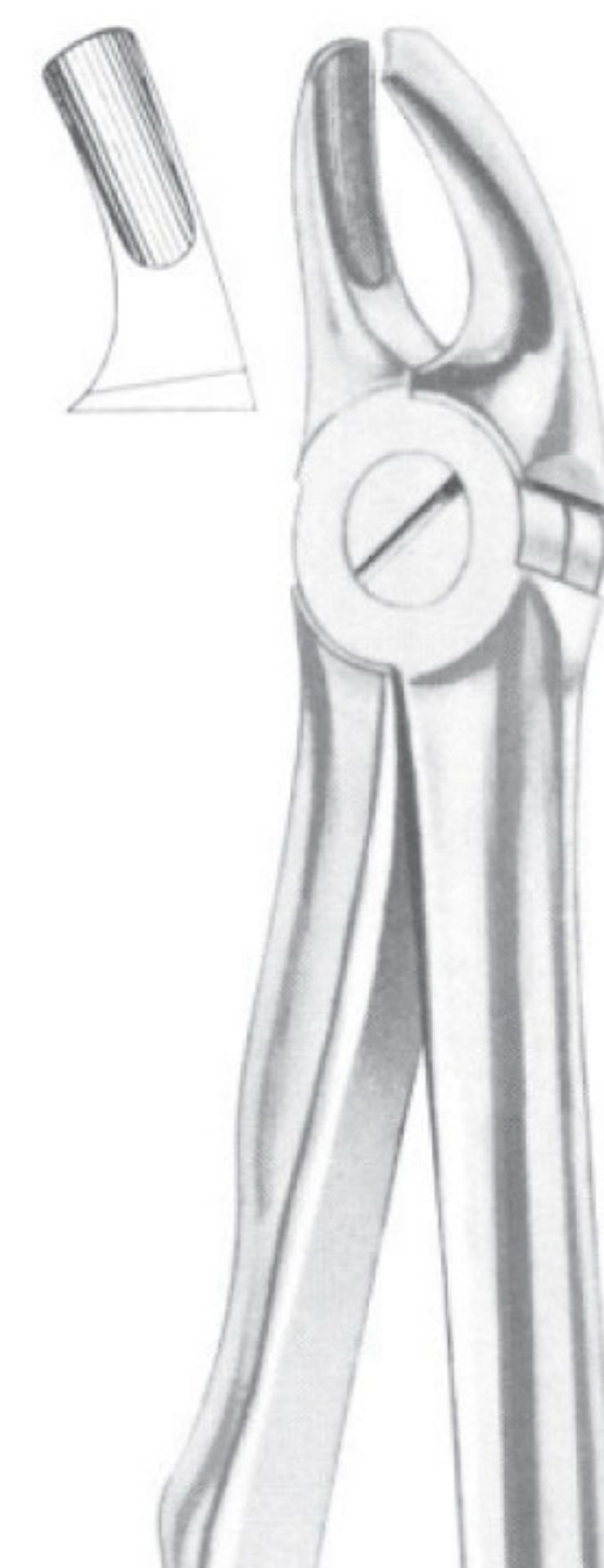

Fig. 39L upper molars left for children
MWD-1172

Fig. 39L upper molars left for children



Fig. 41 upper roots
MWD-1173

Fig. 41 upper roots

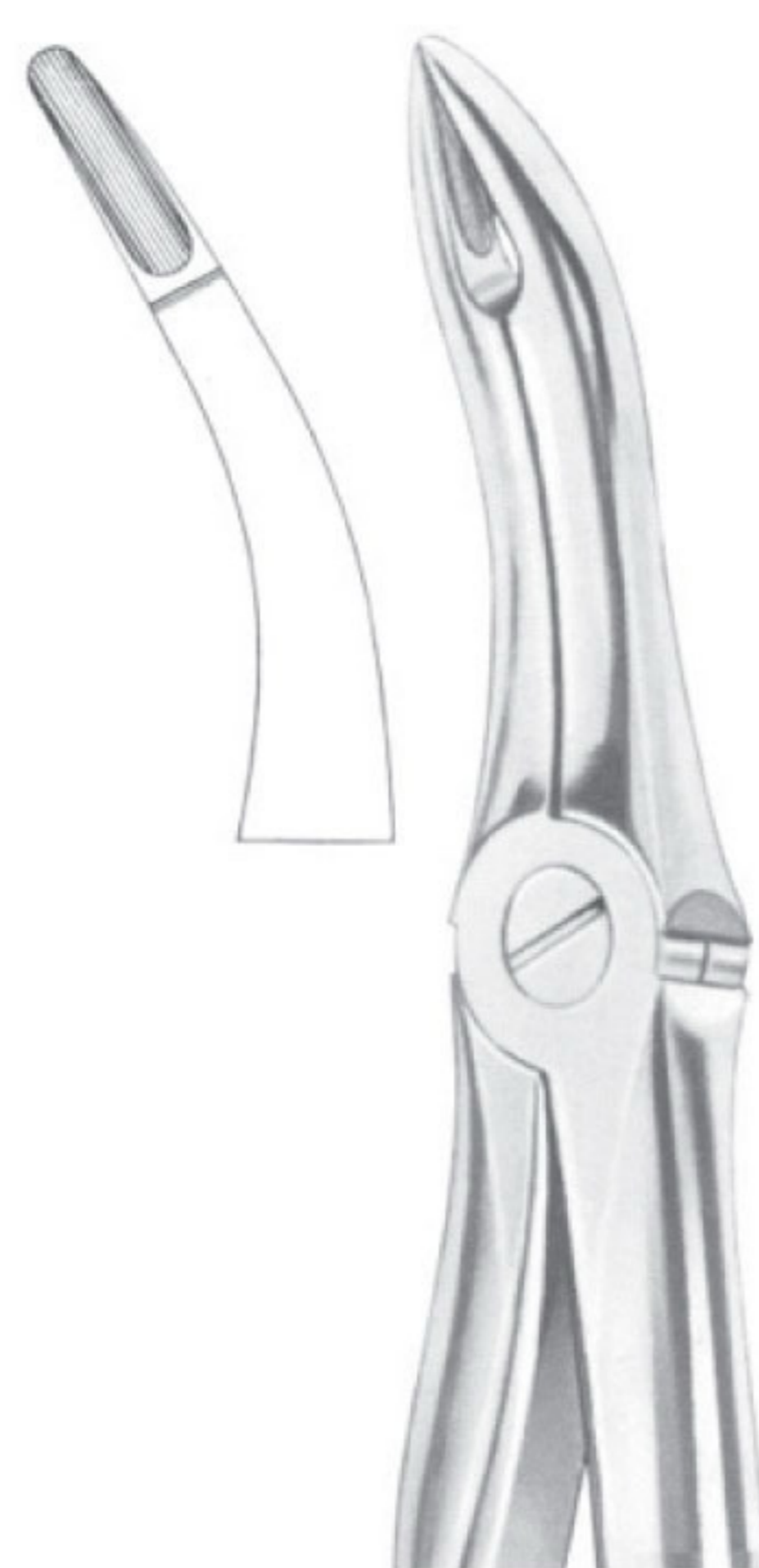

Fig. 44 upper roots
MWD-1174

Fig. 44 upper roots

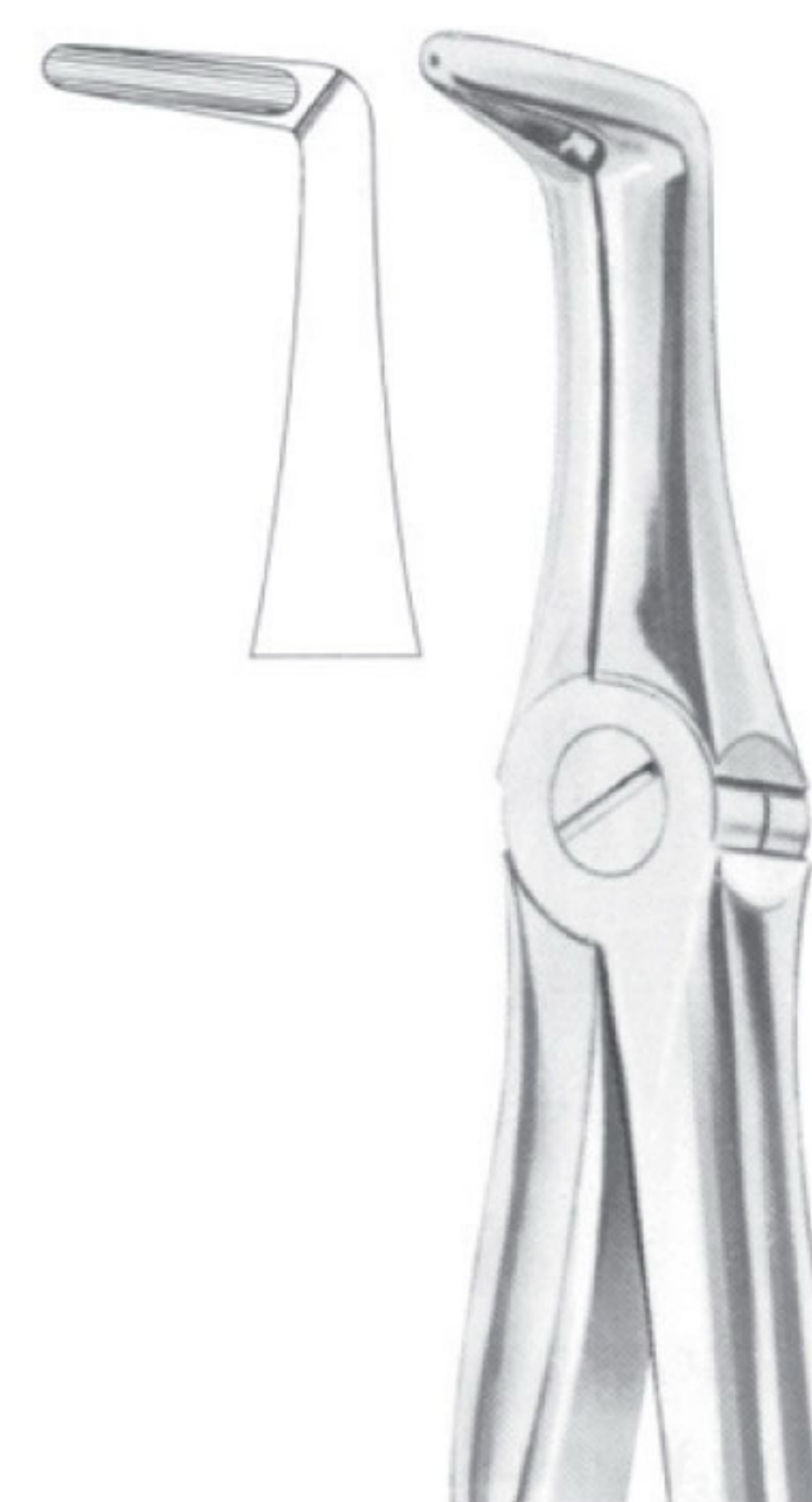

Fig. 45 lower roots
MWD-1175

Fig. 45 lower roots

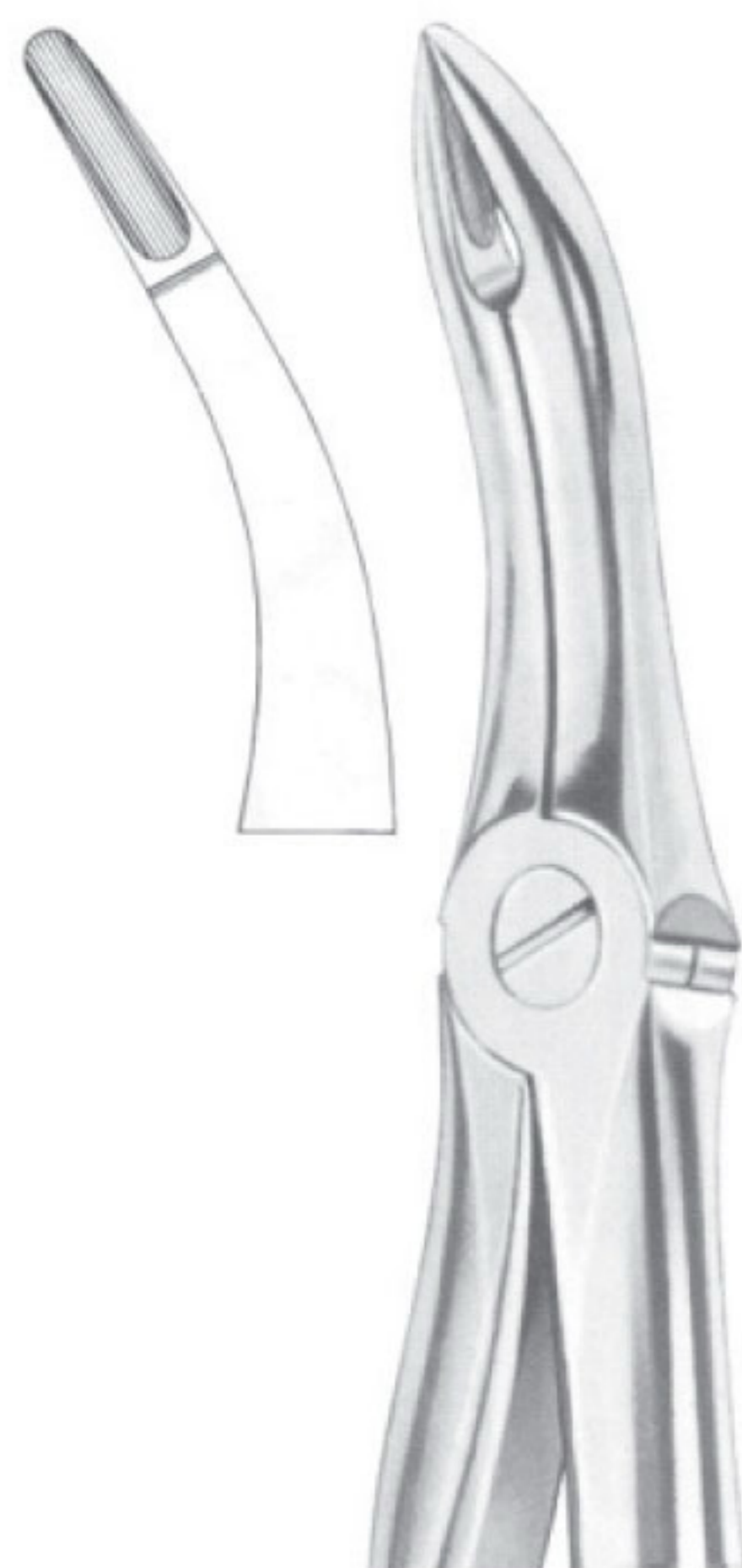

Fig. 48 lower roots
MWD-1176
 Fig. 48 lower roots

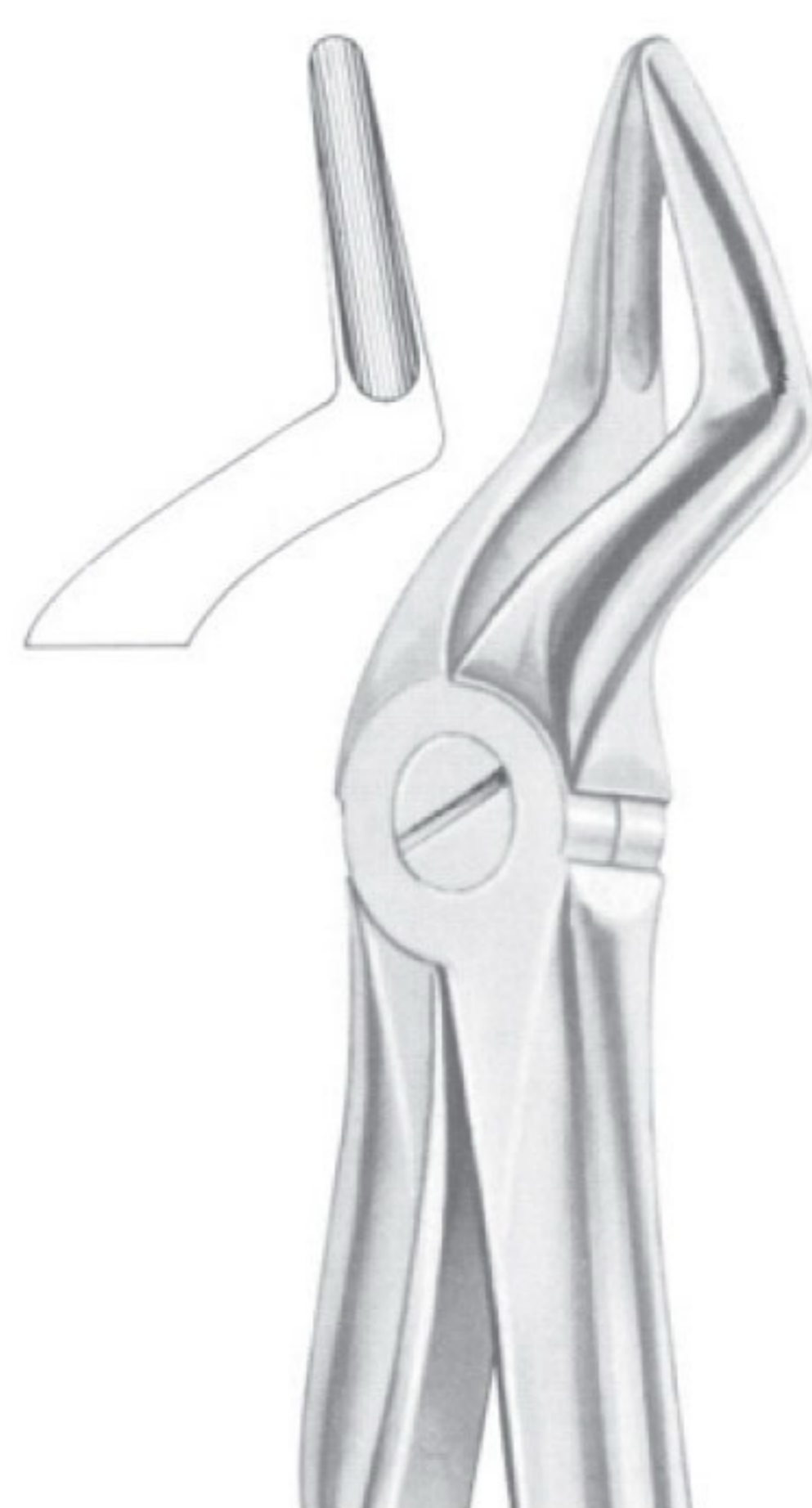

Fig. 51 upper roots
MWD-1177
 Fig. 51 upper roots

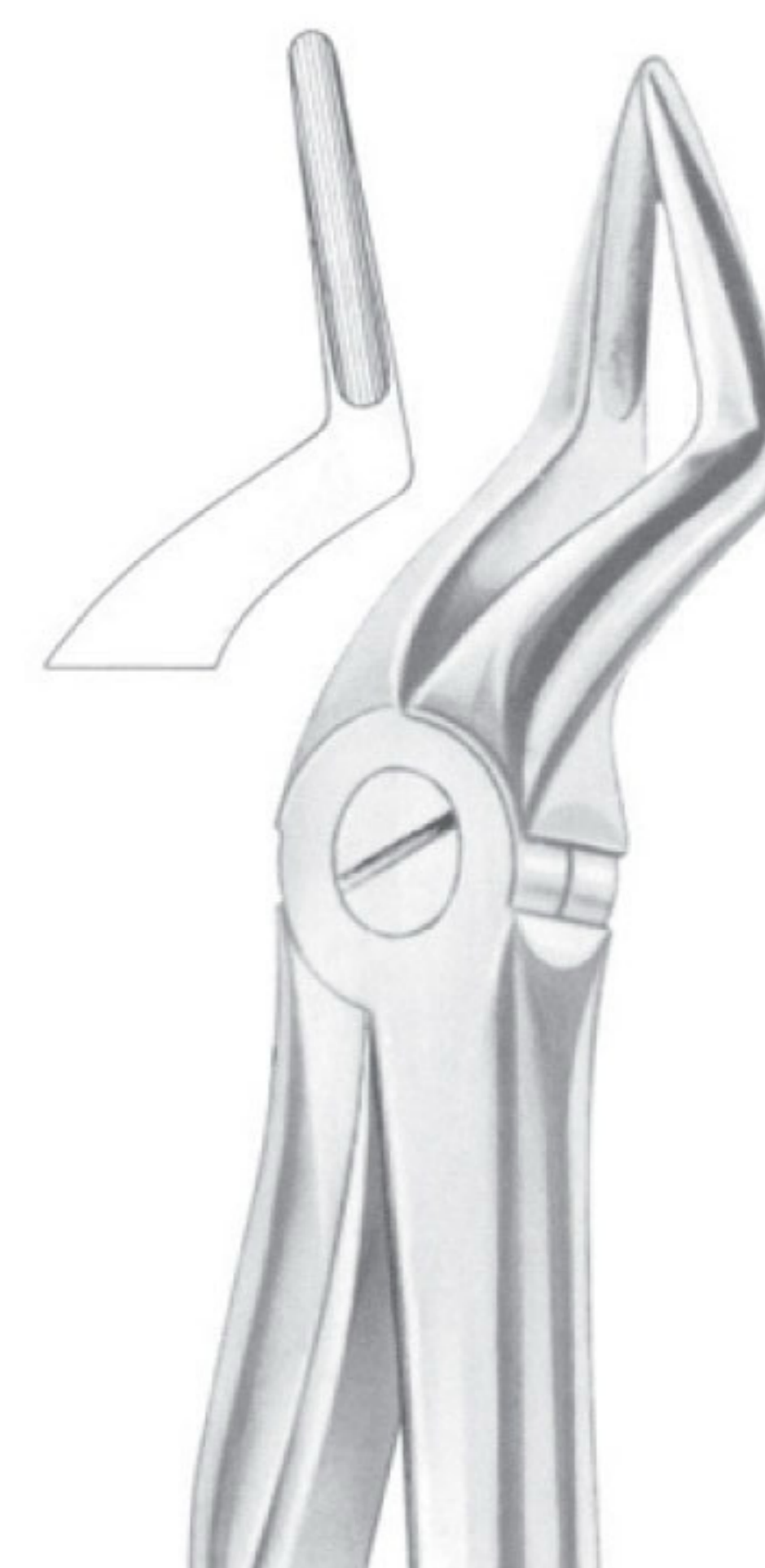

Fig. 51A upper roots
MWD-1178
 Fig. 51A upper roots



Fig. 51L upper roots
MWD-1180
 Fig. 51L upper roots

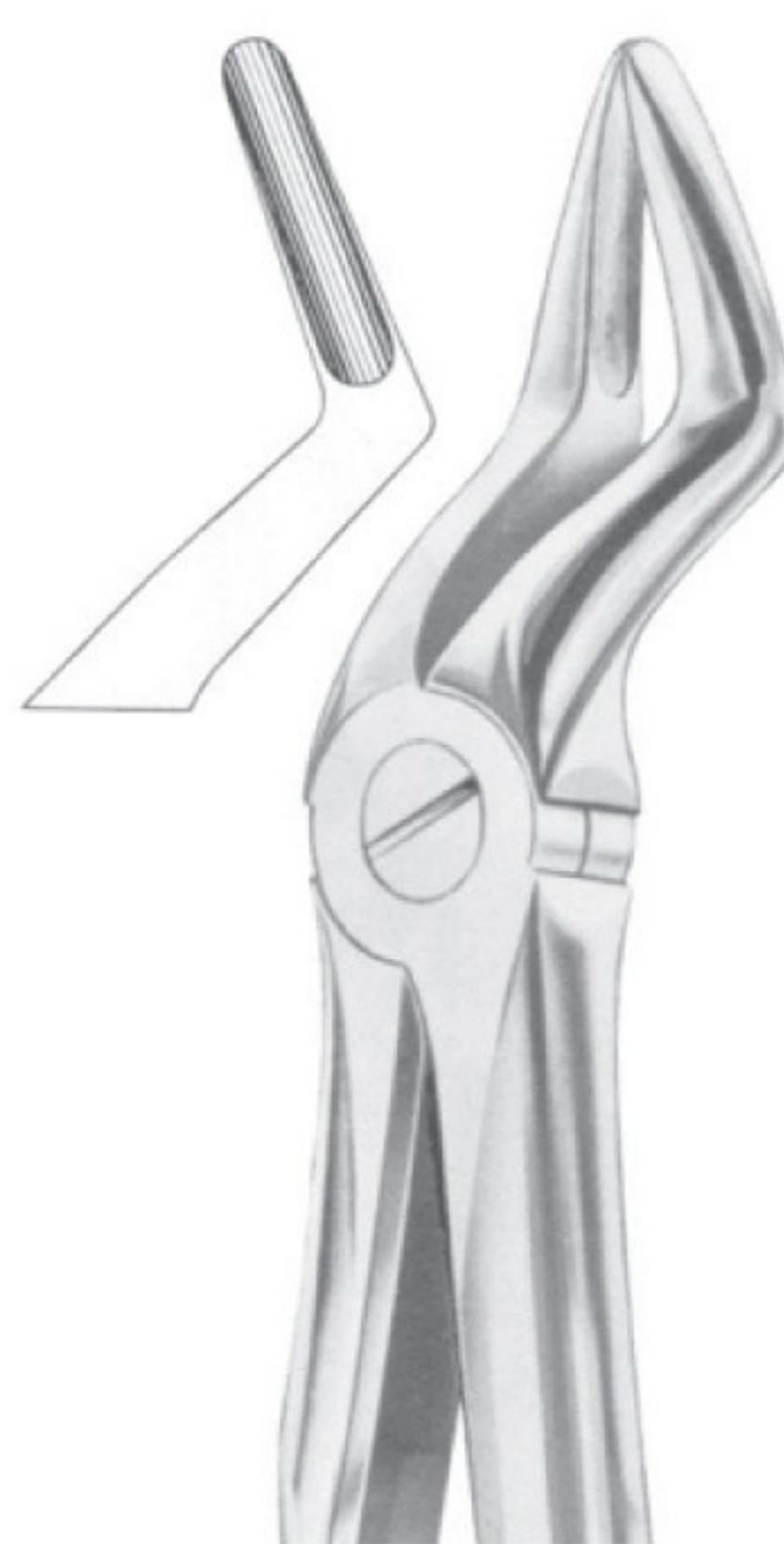

Fig. 52 upper roots
MWD-1181
 Fig. 52 upper roots

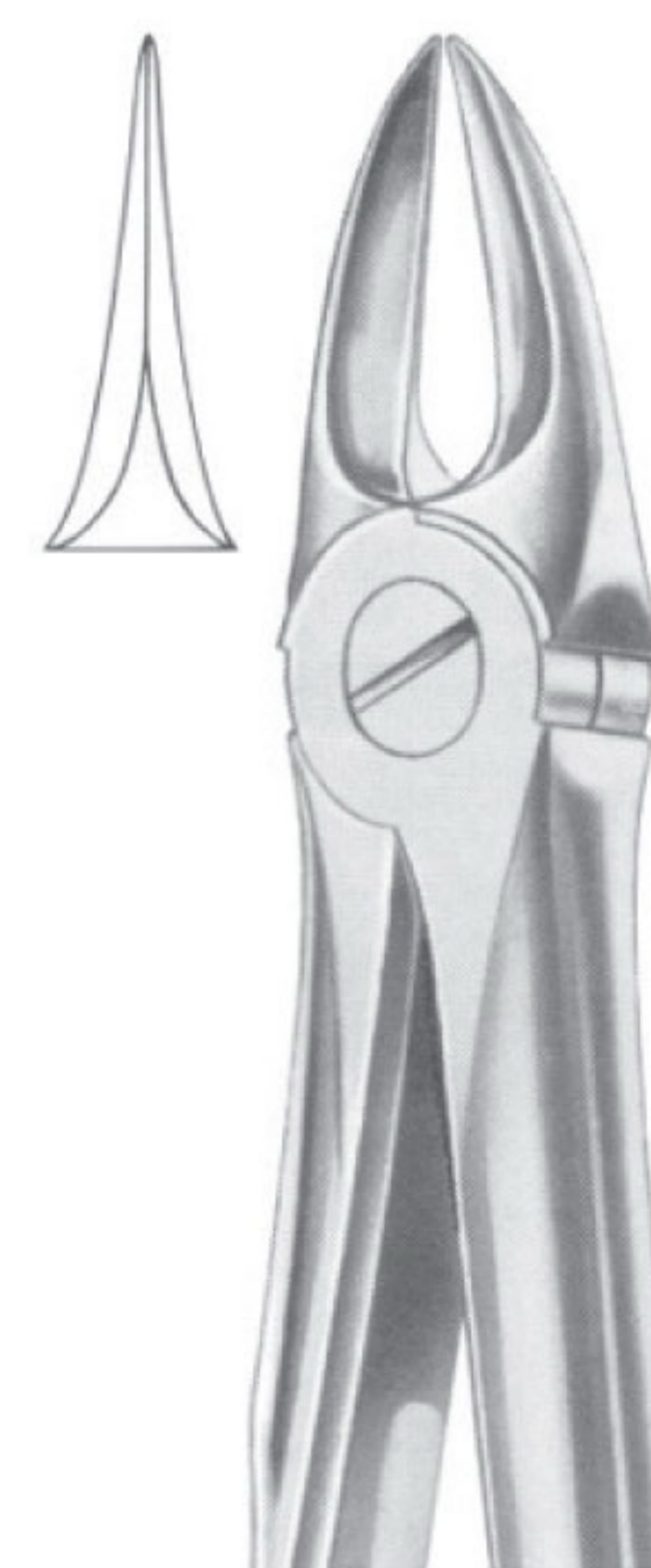

Fig. 54 for separating upper molars
MWD-1182
 Fig. 54 for separating upper molars

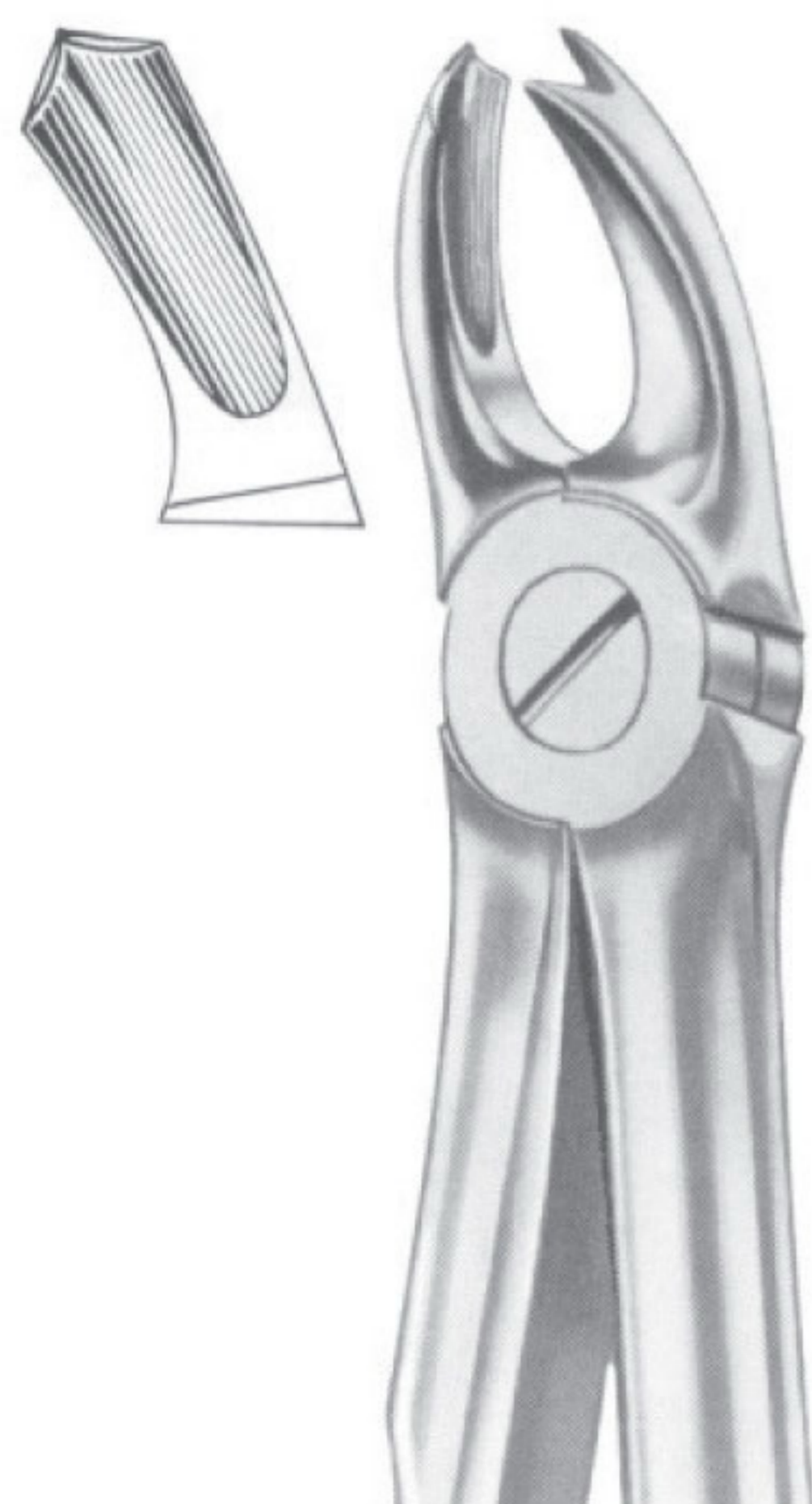

Fig. 65R upper molars right
MWD-1183
 Fig. 65R upper molars right



Fig. 65L upper molars left
MWD-1184
 Fig. 65L upper molars left



Fig. 67 upper third molars
MWD-1185
 Fig. 67 upper third molars

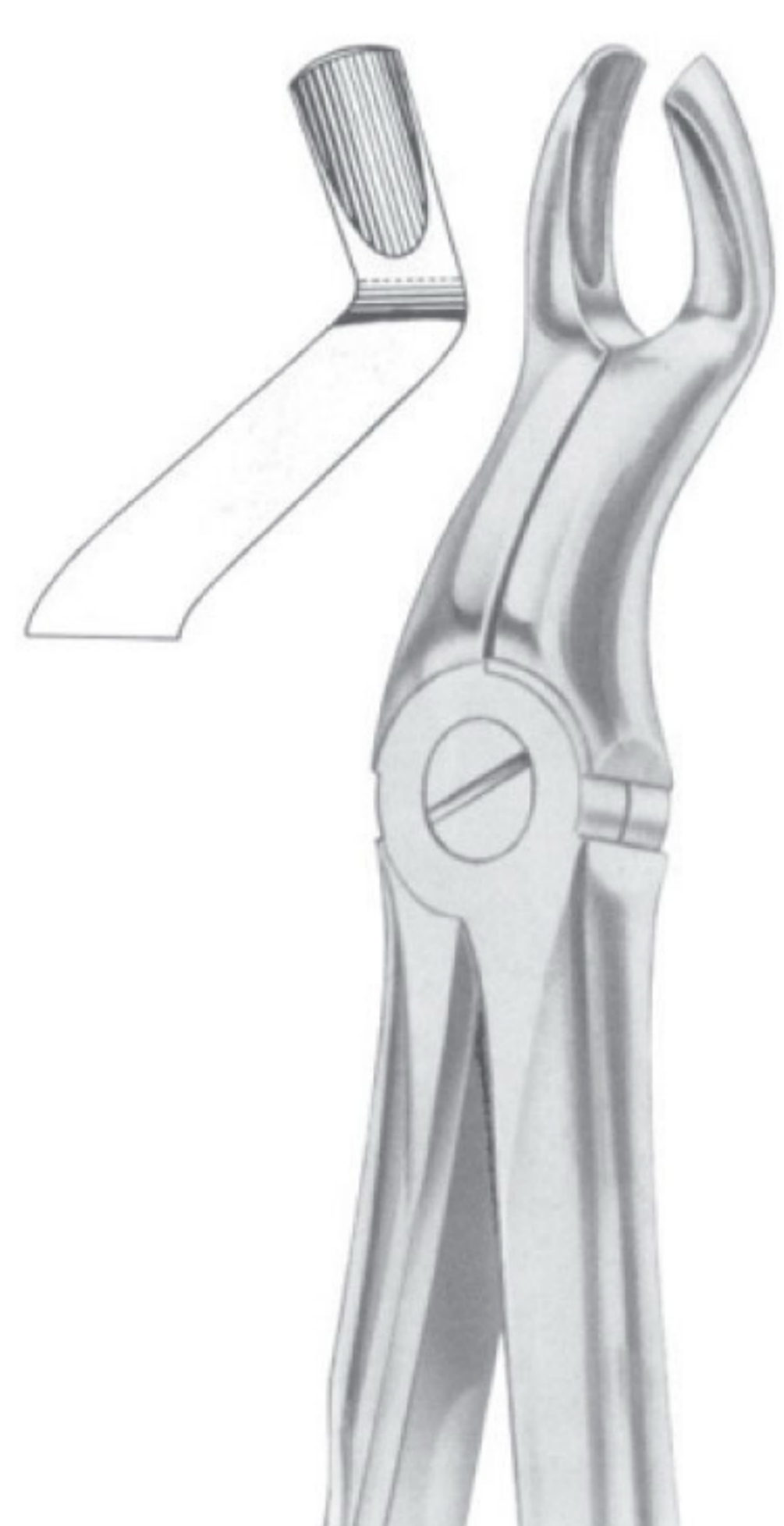

Fig. 67A upper third molars
MWD-1186
 Fig. 67A upper third molars



Fig. 67 1/2 R upper third molars right
MWD-1187
 Fig. 67 1/2 R upper third molars right

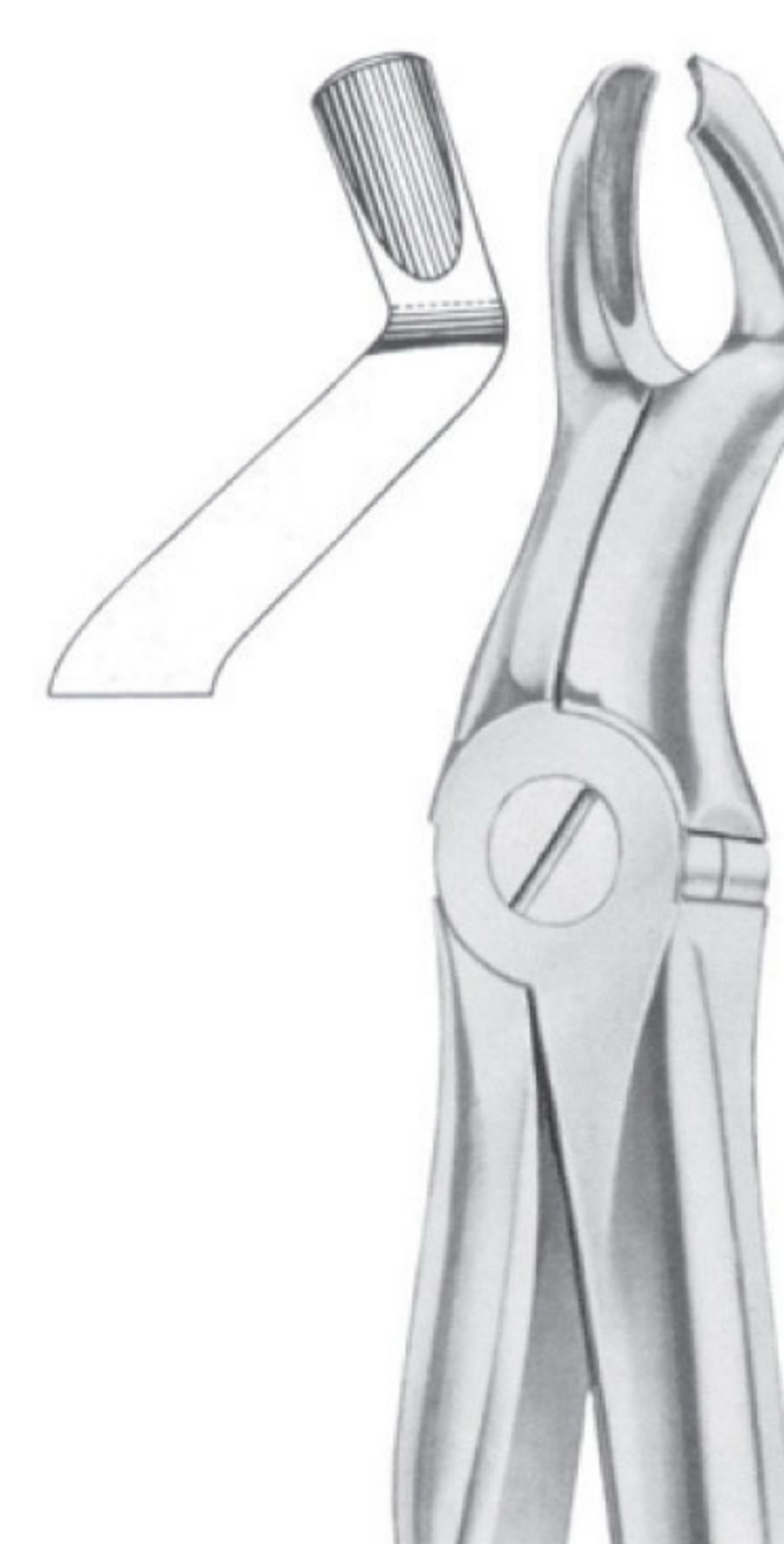

Fig. 67 1/2 L upper third molars left
MWD-1188
 Fig. 67 1/2 L upper third molars left

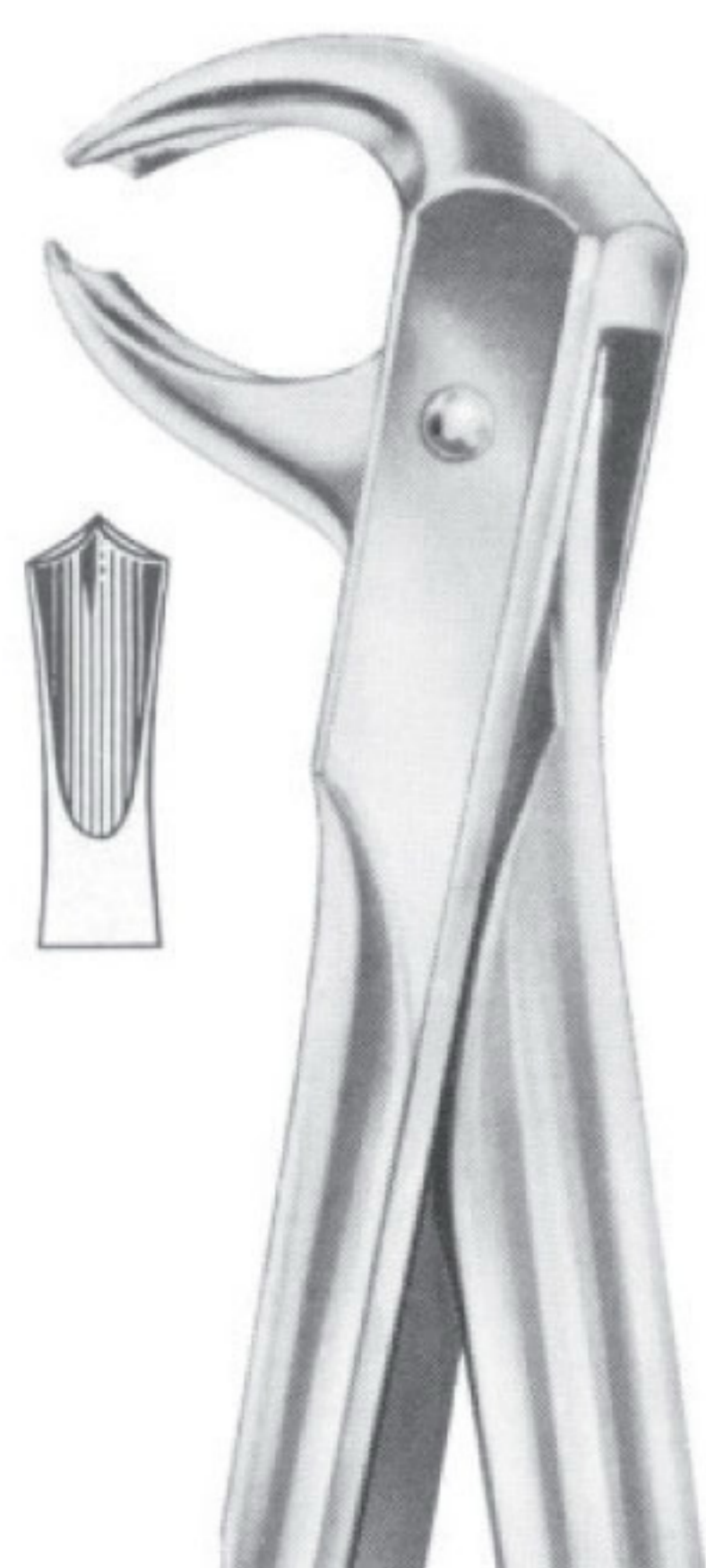

Fig. 73 lower molars
MWD-1189
Fig. 73 lower molars

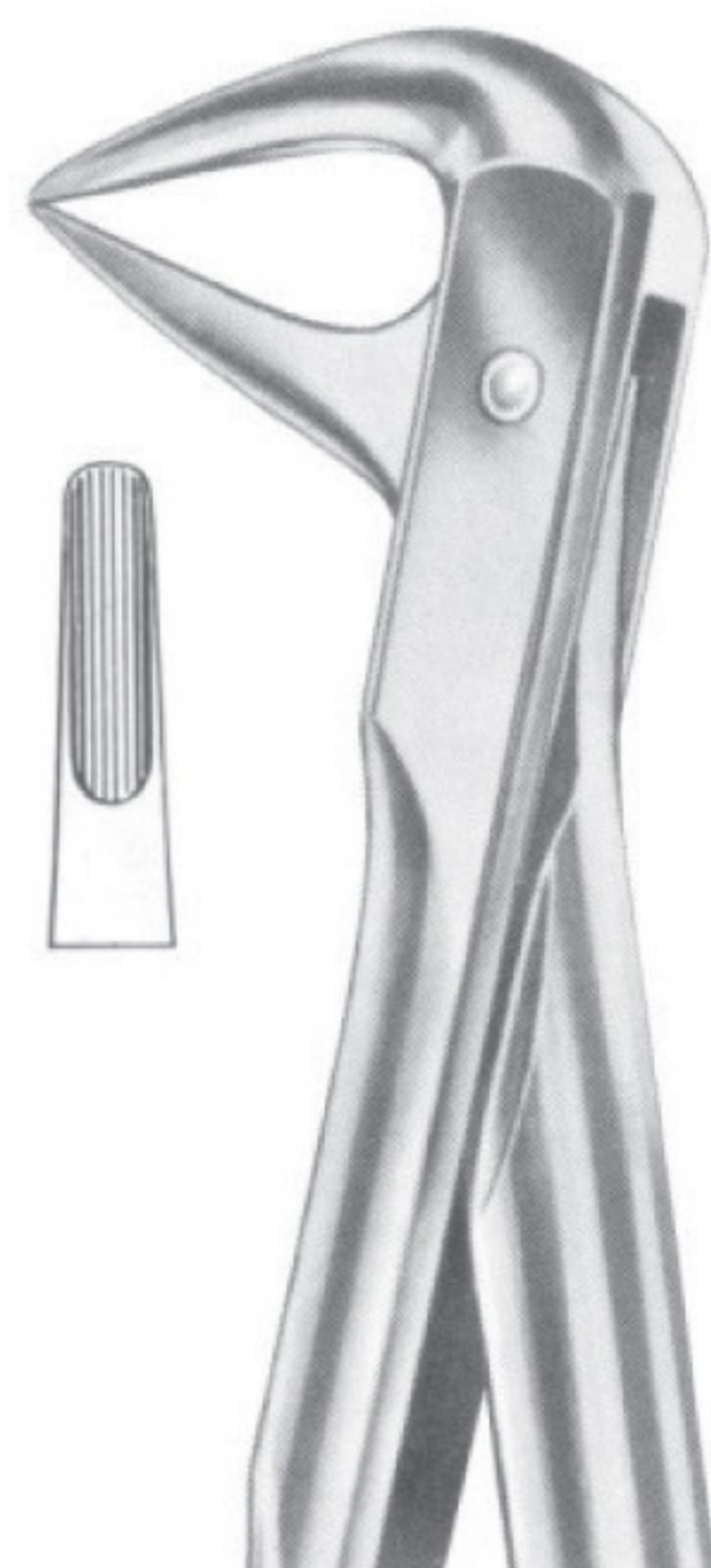

Fig. 74 lower roots
MWD-1190
Fig. 74 lower roots

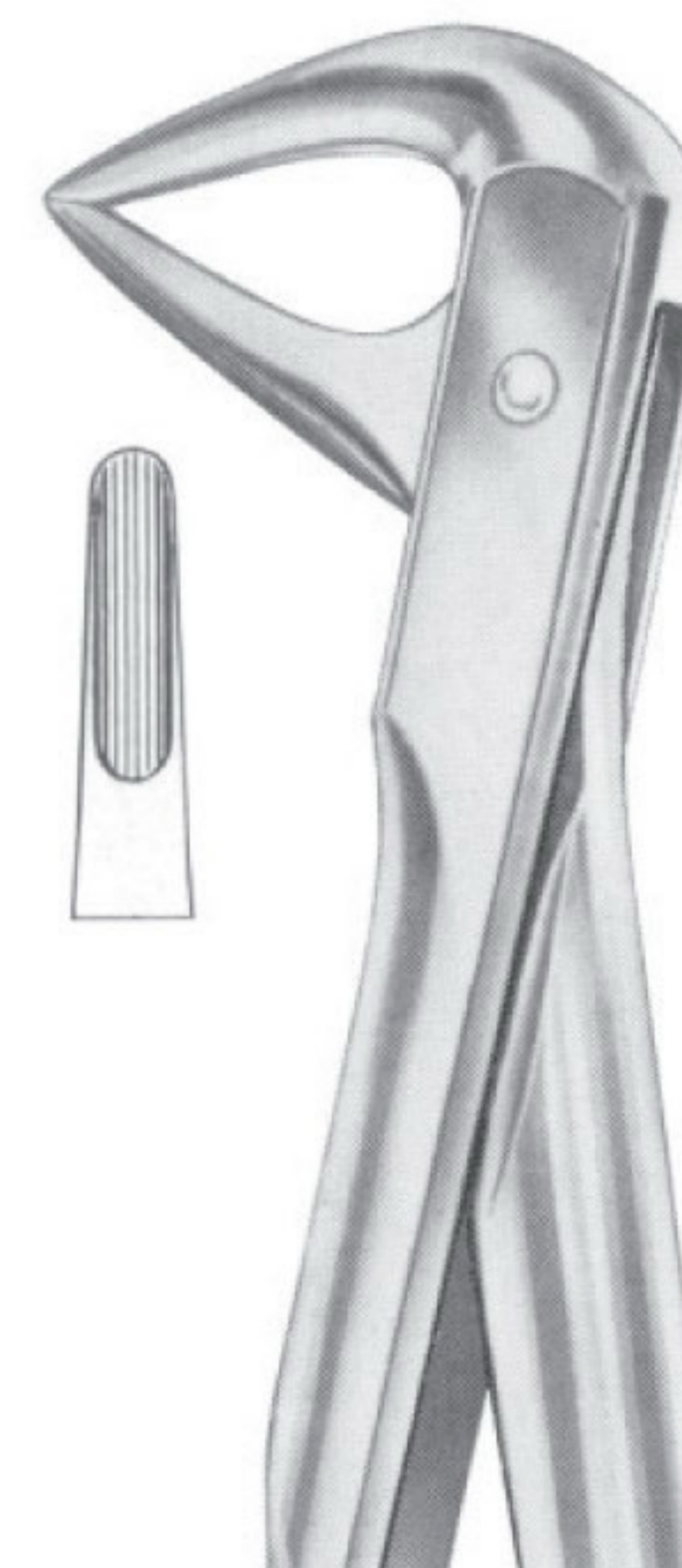

Fig. 74M lower roots
MWD-1191
Fig. 74M lower roots

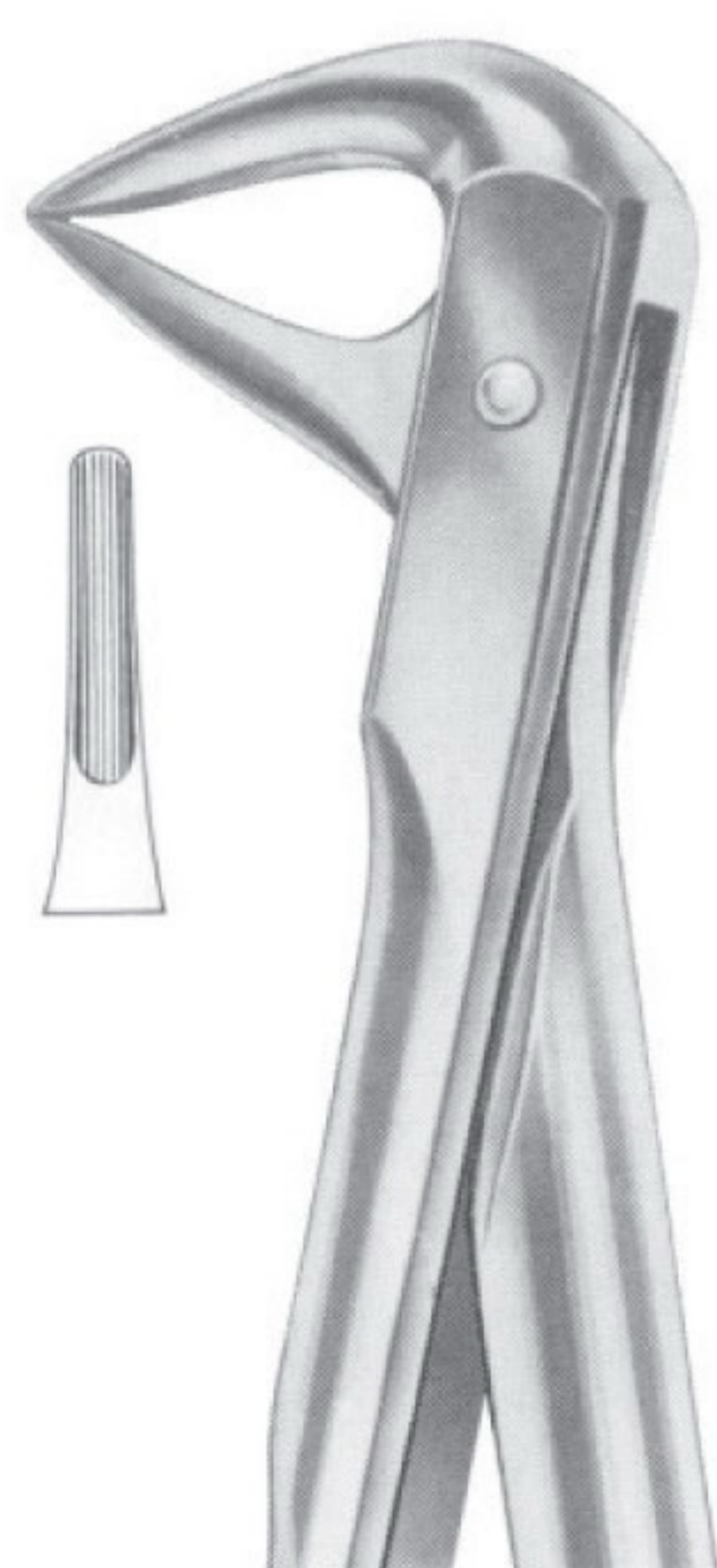

Fig. 74N lower roots
MWD-1192
Fig. 74N lower roots

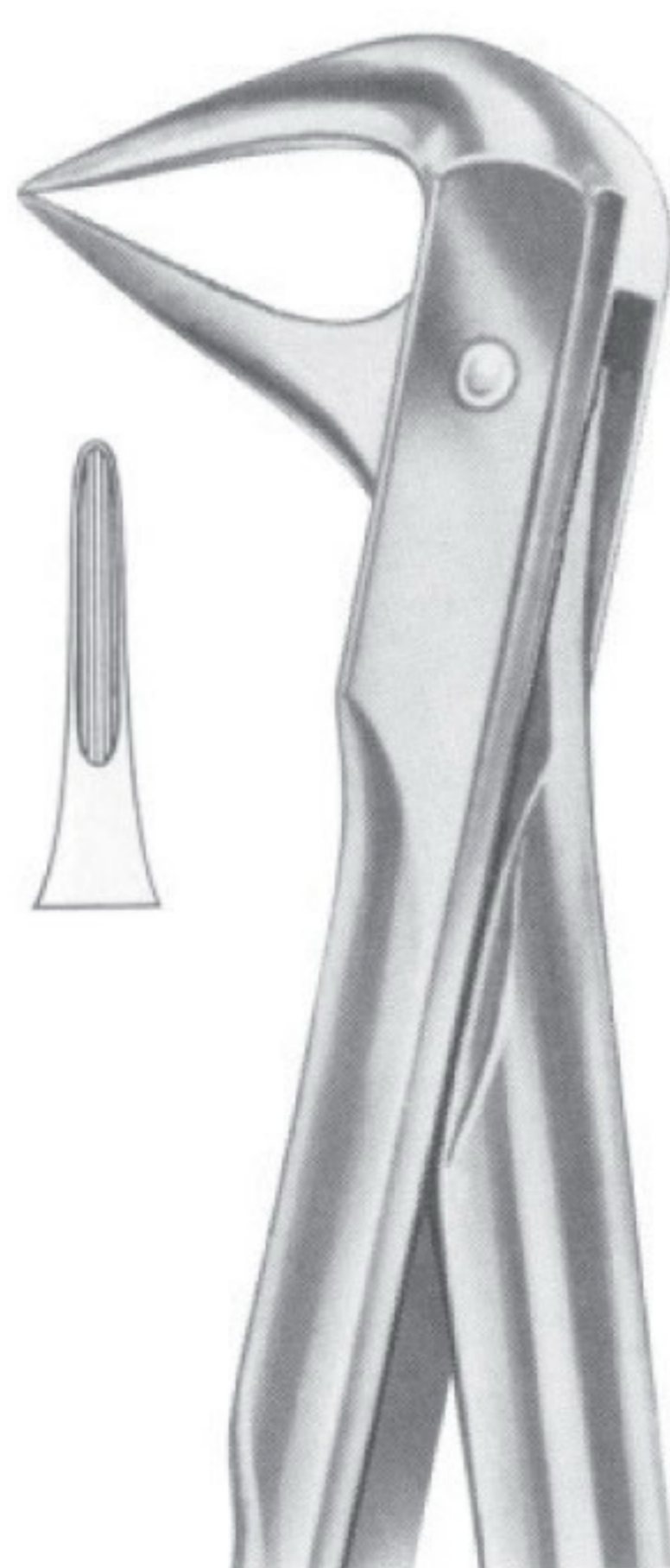

Fig. 74XN lower roots and crowded incisors
MWD-1193
Fig. 74XN lower roots and crowded incisors



Fig. 75 lower premolars
MWD-1194
Fig. 75 lower premolars



Fig. 76 upper roots
MWD-1195
Fig. 76 upper roots



Fig. 76N upper roots
MWD-1196
Fig. 76N upper roots

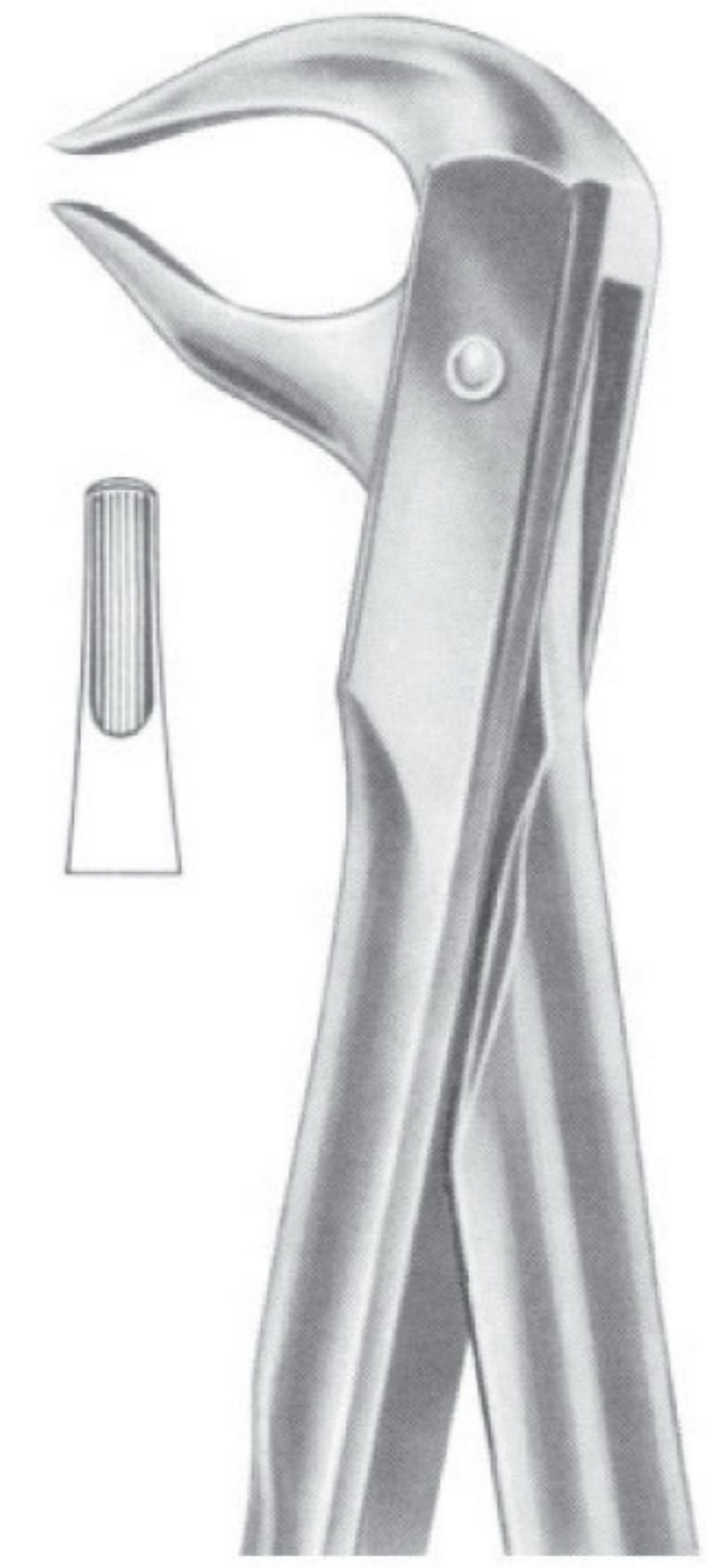

Fig. 81 lower premolars and roots
MWD-1197
Fig. 81 lower premolars and roots

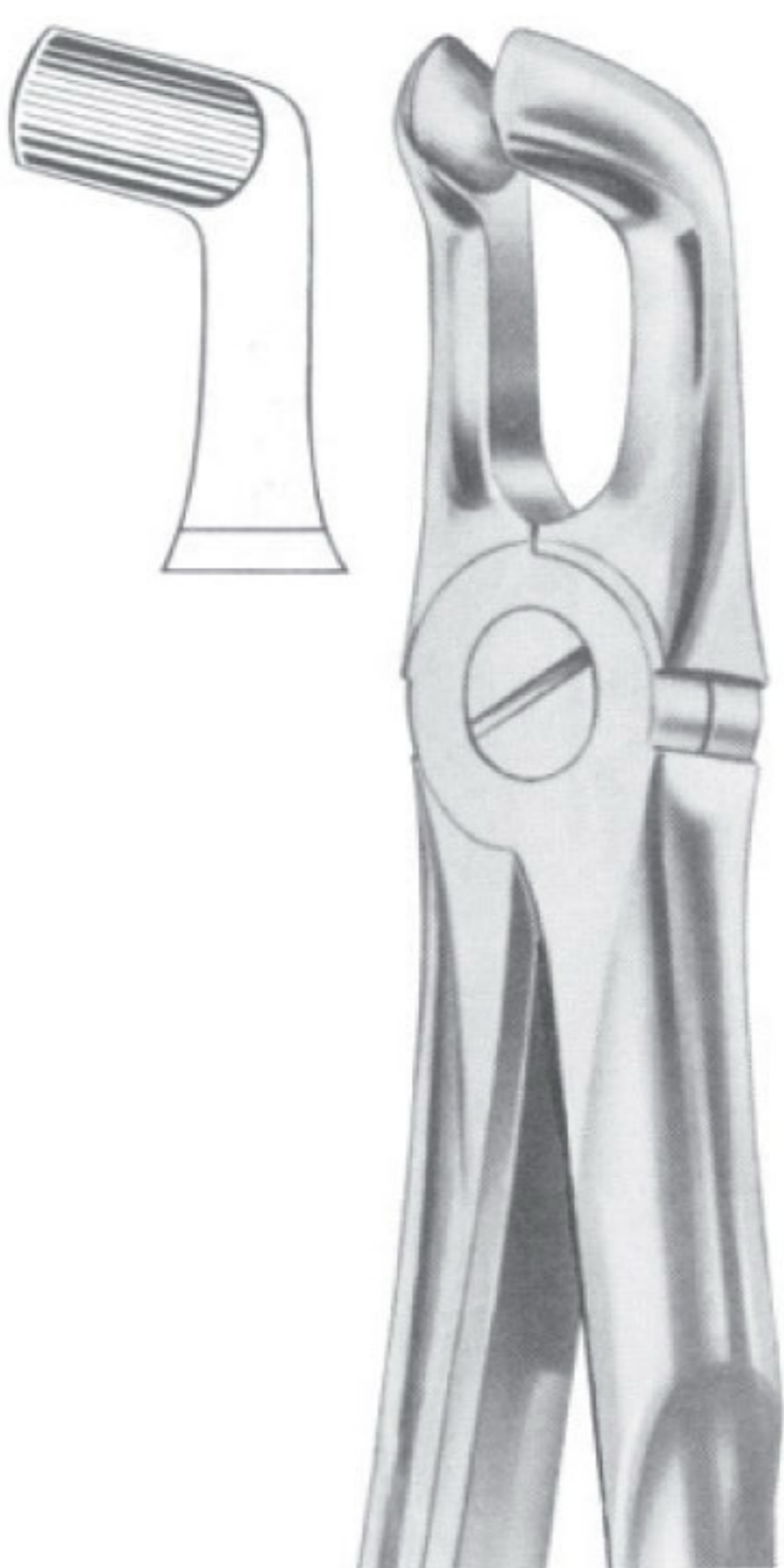

Fig. 76A lower third molars
MWD-1198
Fig. 76A lower third molars



Fig. 79 lower third molars
MWD-1199
Fig. 79 lower third molars



Fig. 86A lower molars
MWD-1200
Fig. 86A lower molars



Fig. 86B lower molars
MWD-1201
Fig. 86B lower molars



Fig. 86C lower molars
MWD-1202
Fig. 86C lower molars

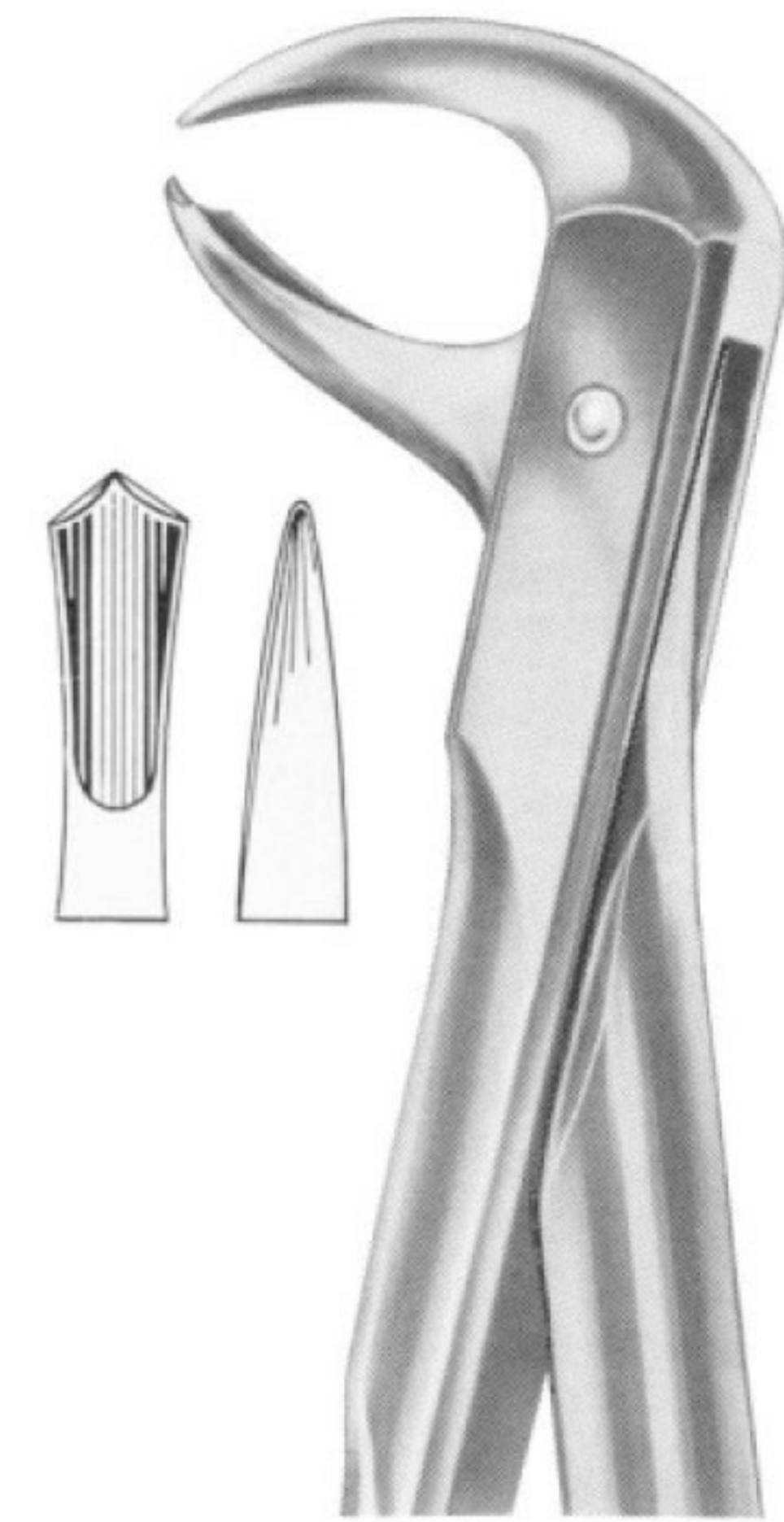

Fig. 99 lower molars
MWD-1203
Fig. 99 lower molars

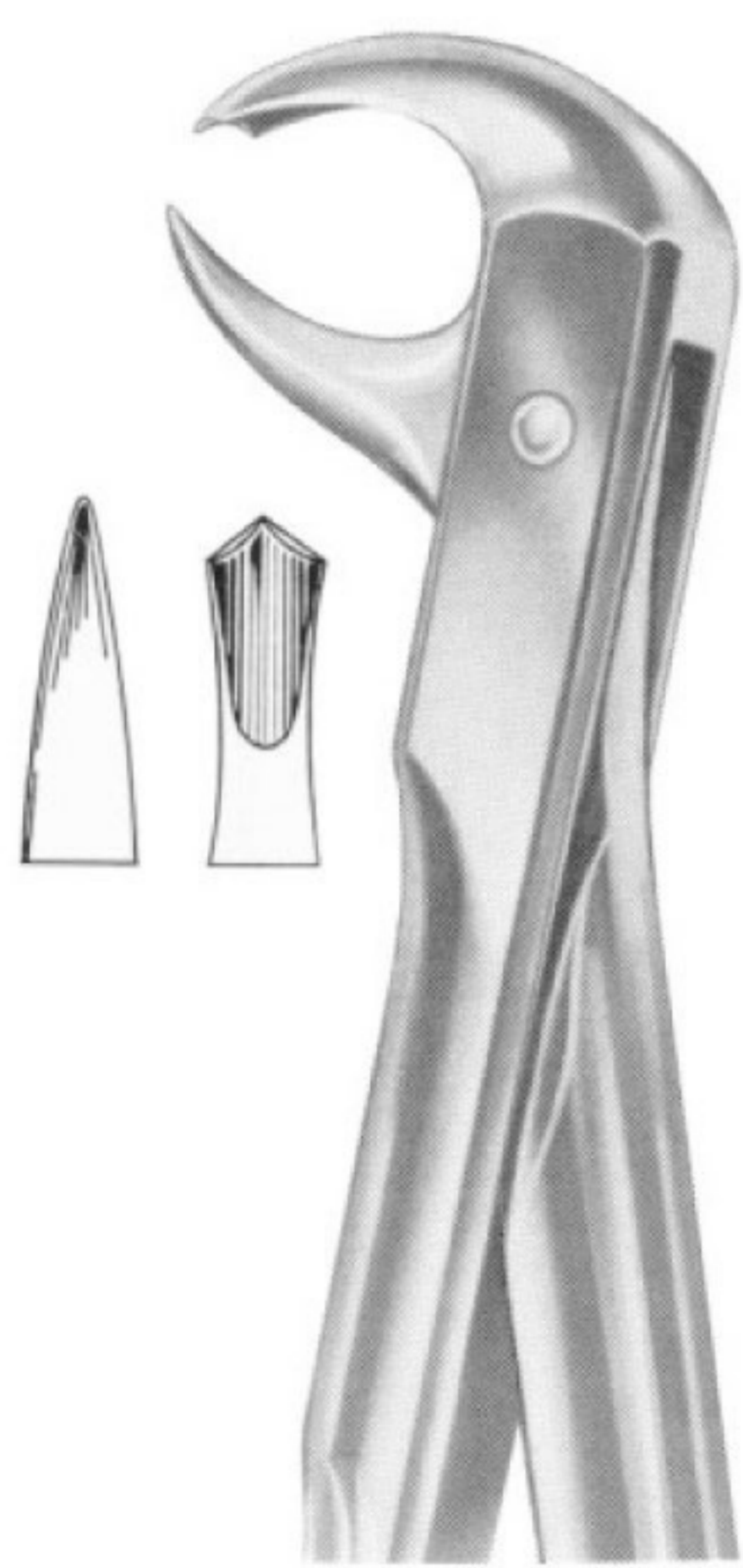

Fig. 99 1/4 lower molars
MWD-1204
Fig. 99 1/4 lower molars

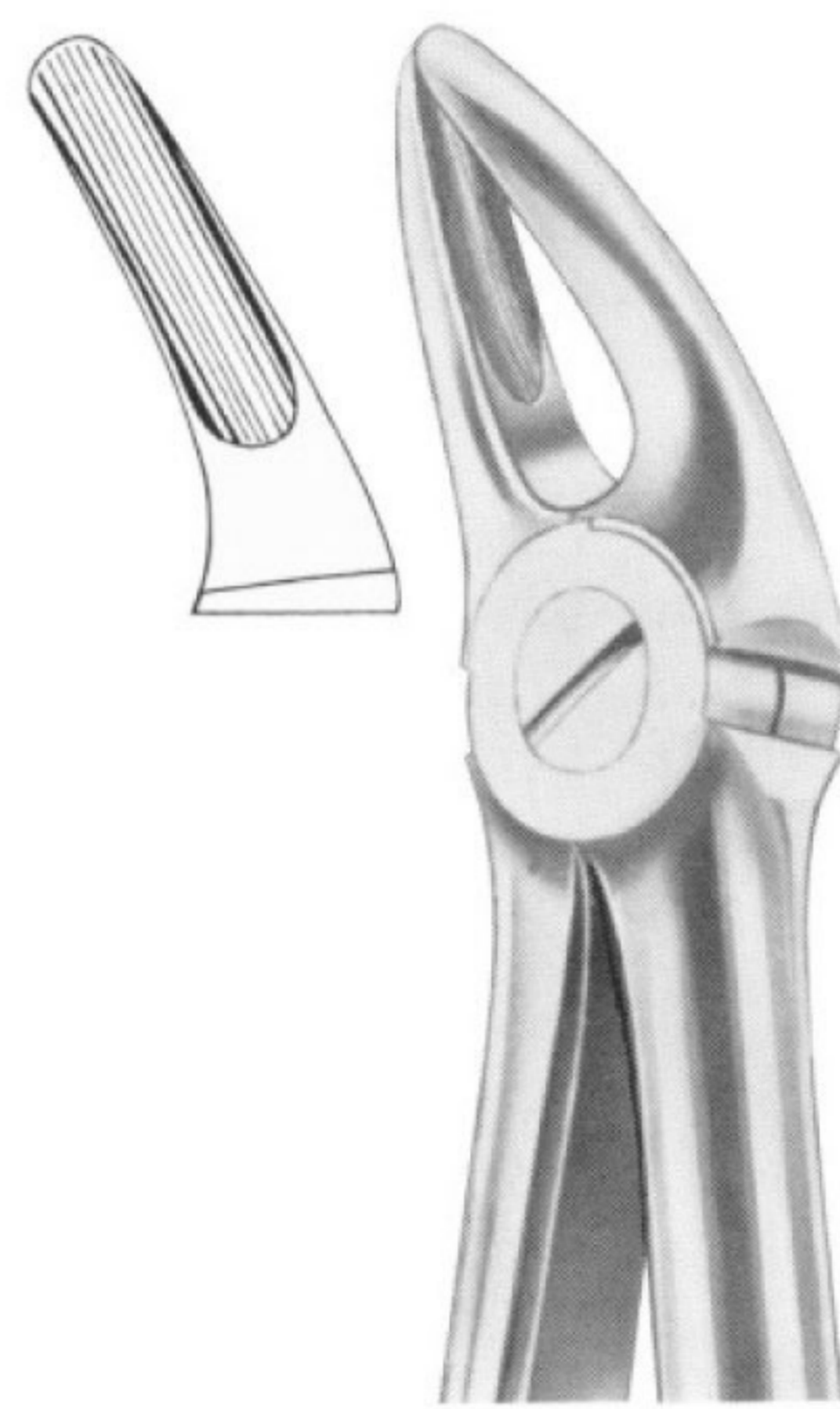

Fig. 136 upper premolars and roots
MWD-1205
Fig. 136 upper premolars and roots

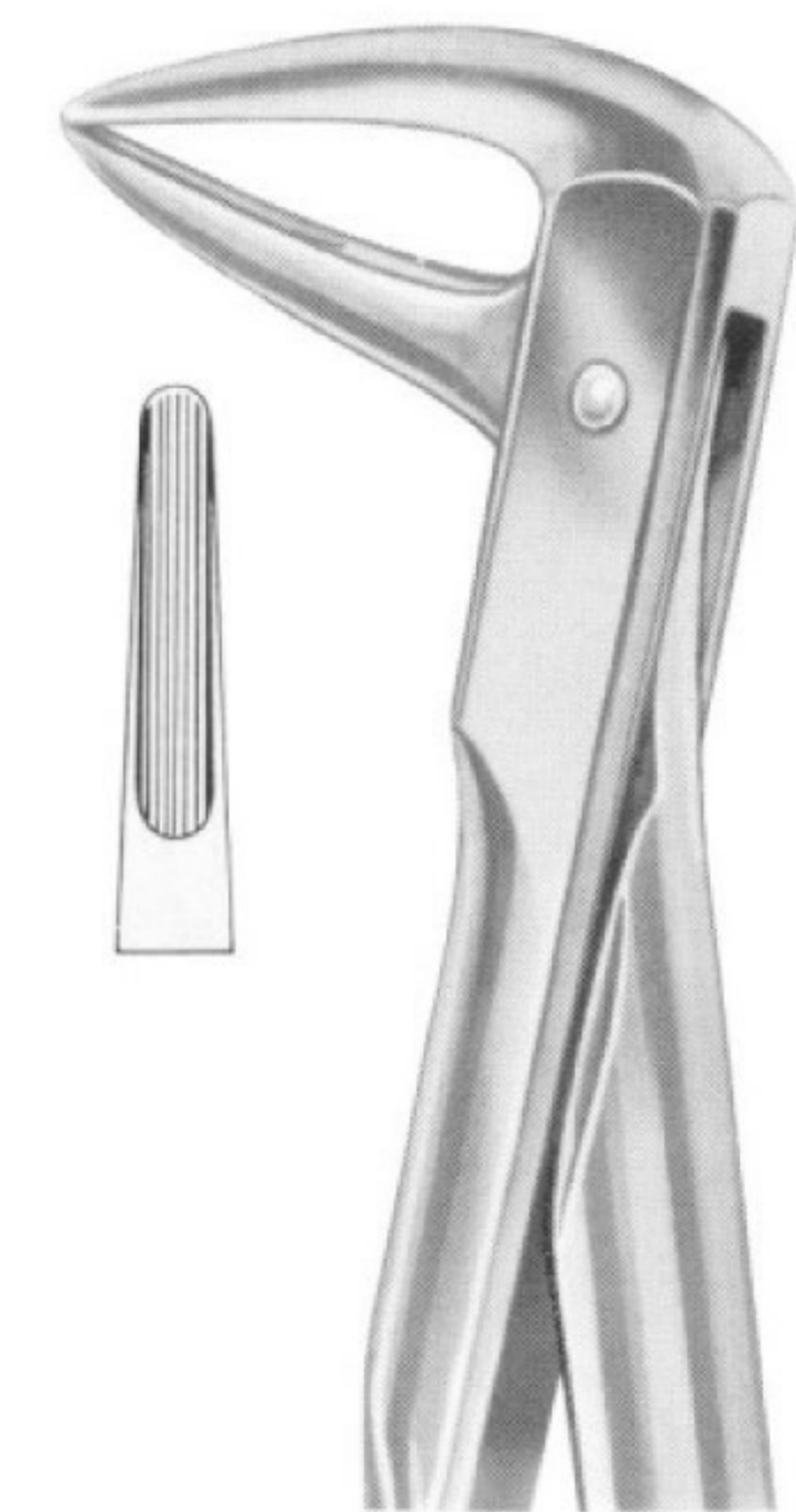

Fig. 143 lower roots
MWD-1206
Fig. 143 lower roots



KLEIN (Fig. 217) upper incisors
MWD-1207
 KLEIN (Fig. 217) upper incisors



KLEIN (Fig. 218) upper premolars
MWD-1208
 KLEIN (Fig. 218) upper premolars



KLEIN (Fig. 219) upper roots
MWD-1209
 KLEIN (Fig. 219) upper roots

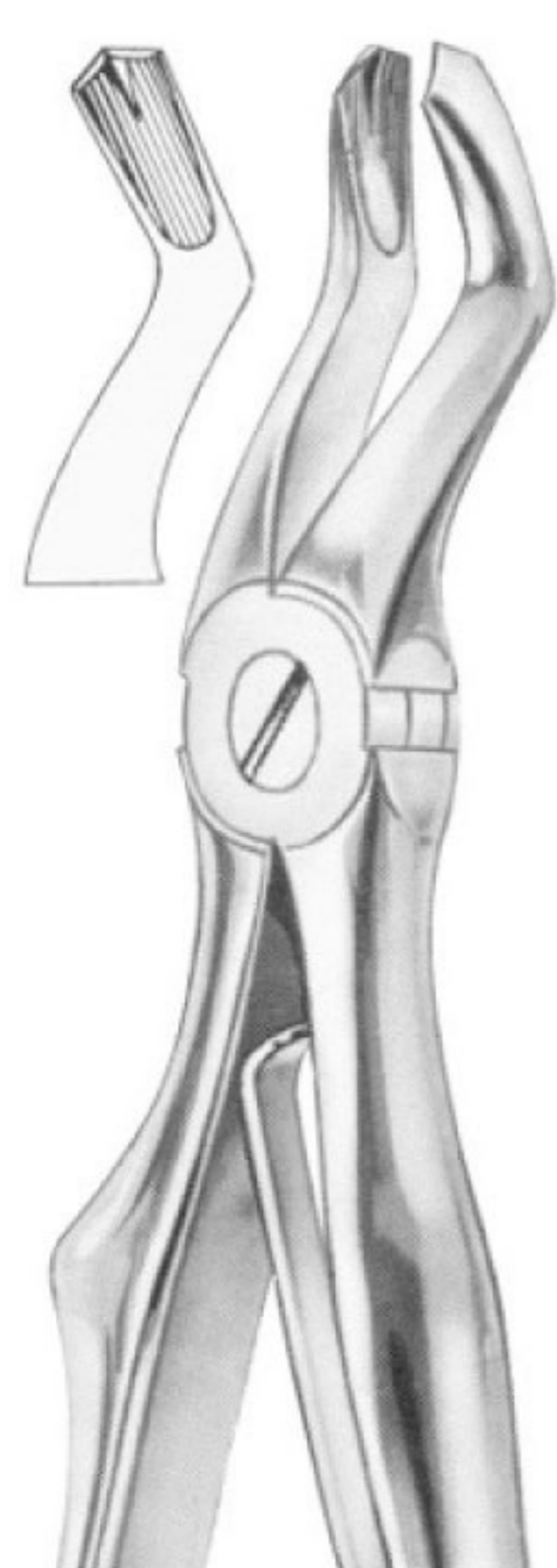

KLEIN (Fig. 220) upper molars
MWD-1210
 KLEIN (Fig. 220) upper molars



KLEIN (Fig. 221) lower incisors
MWD-1211
 KLEIN (Fig. 221) lower incisors

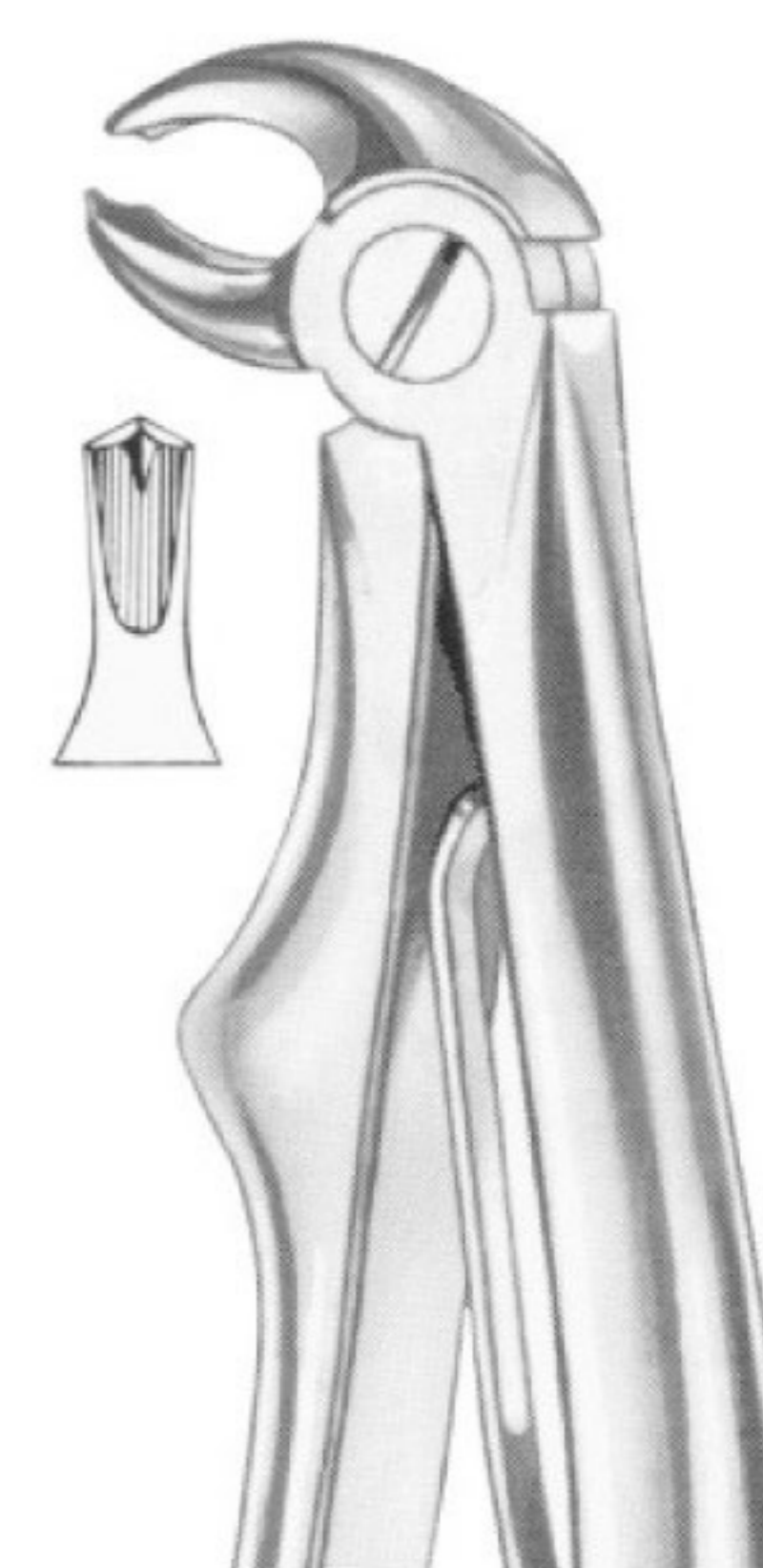

KLEIN (Fig. 222) lower molars
MWD-1212
 KLEIN (Fig. 222) lower molars

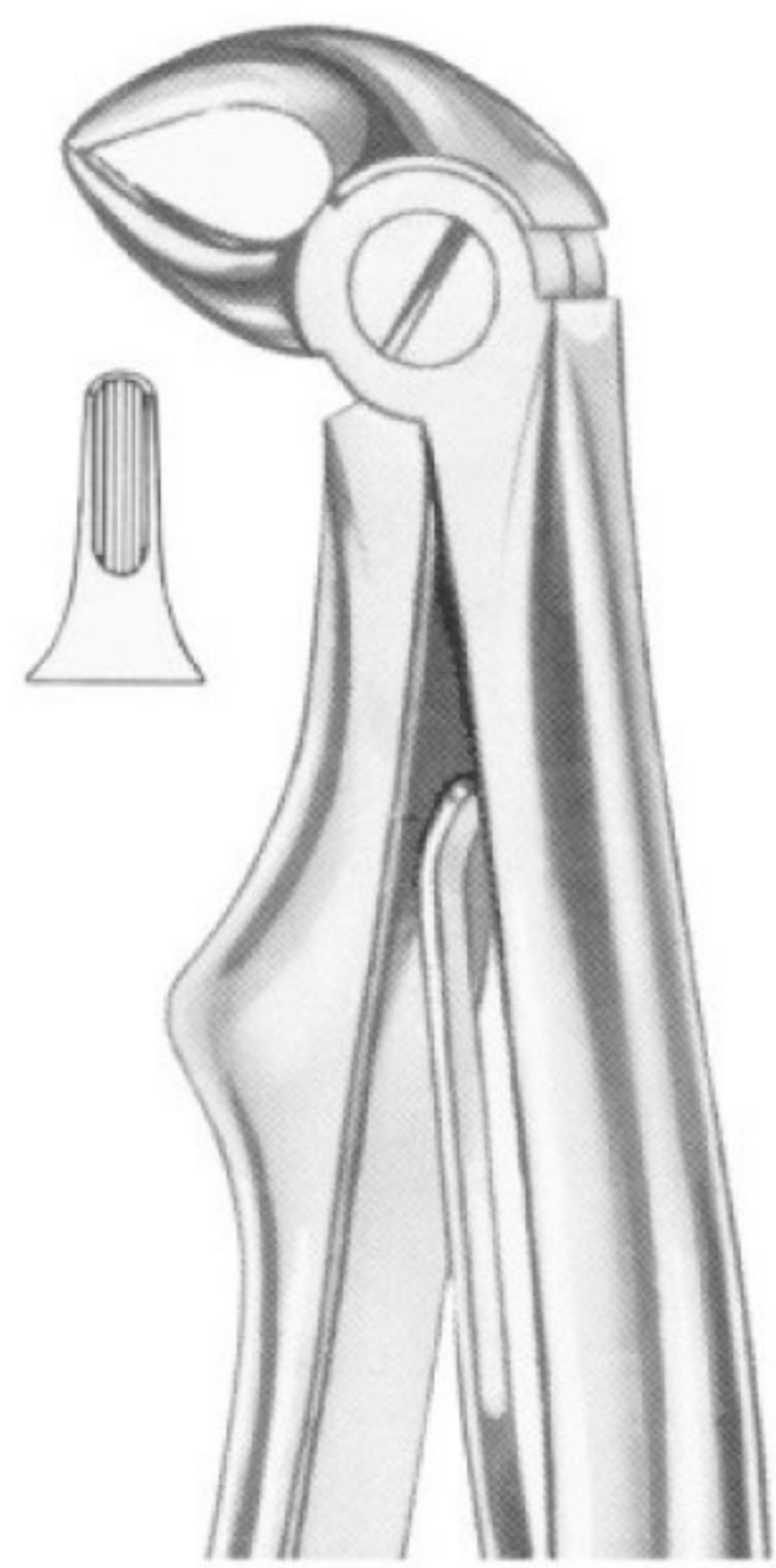

KLEIN (Fig. 223) lower roots
MWD-1213
 KLEIN (Fig. 223) lower roots



ALBRECHT Fig. 224 Deciduous
MWD-1214
 ALBRECHT Fig. 224 Deciduous



ALBRECHT Fig. 225 Deciduous
MWD-1215
 ALBRECHT Fig. 225 Deciduous



WITZEL Fig. 226 lower roots
MWD-1216
 WITZEL Fig. 226 lower roots

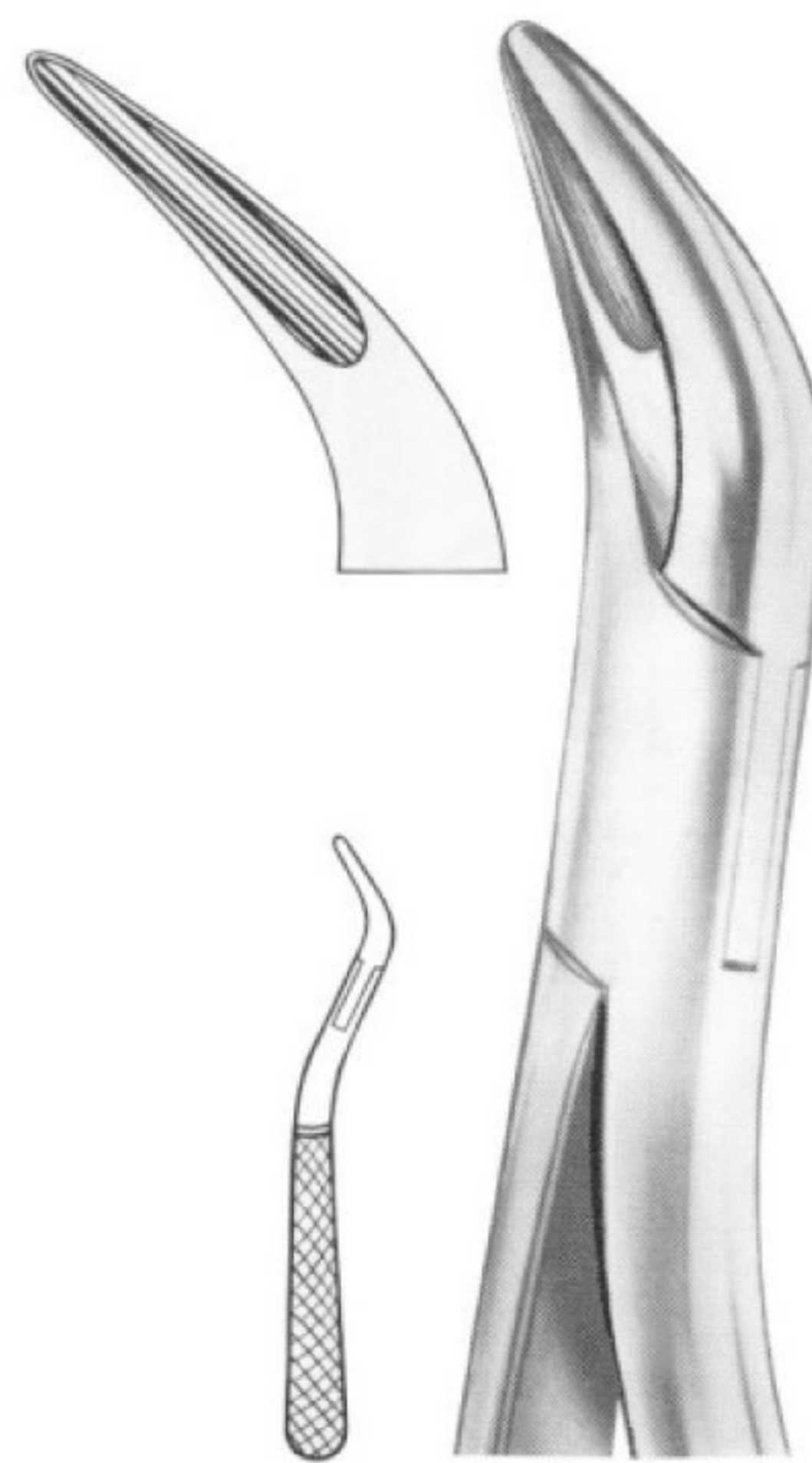

WITZEL Fig. 227 upper roots
MWD-1217
 WITZEL Fig. 227 upper roots



ARTHUR Fig. 228 root fragments
MWD-1218
 ARTHUR Fig. 228 root fragments



STIEGLITZ Fig. 229 root fragments
MWD-1219
 STIEGLITZ Fig. 229 root fragments

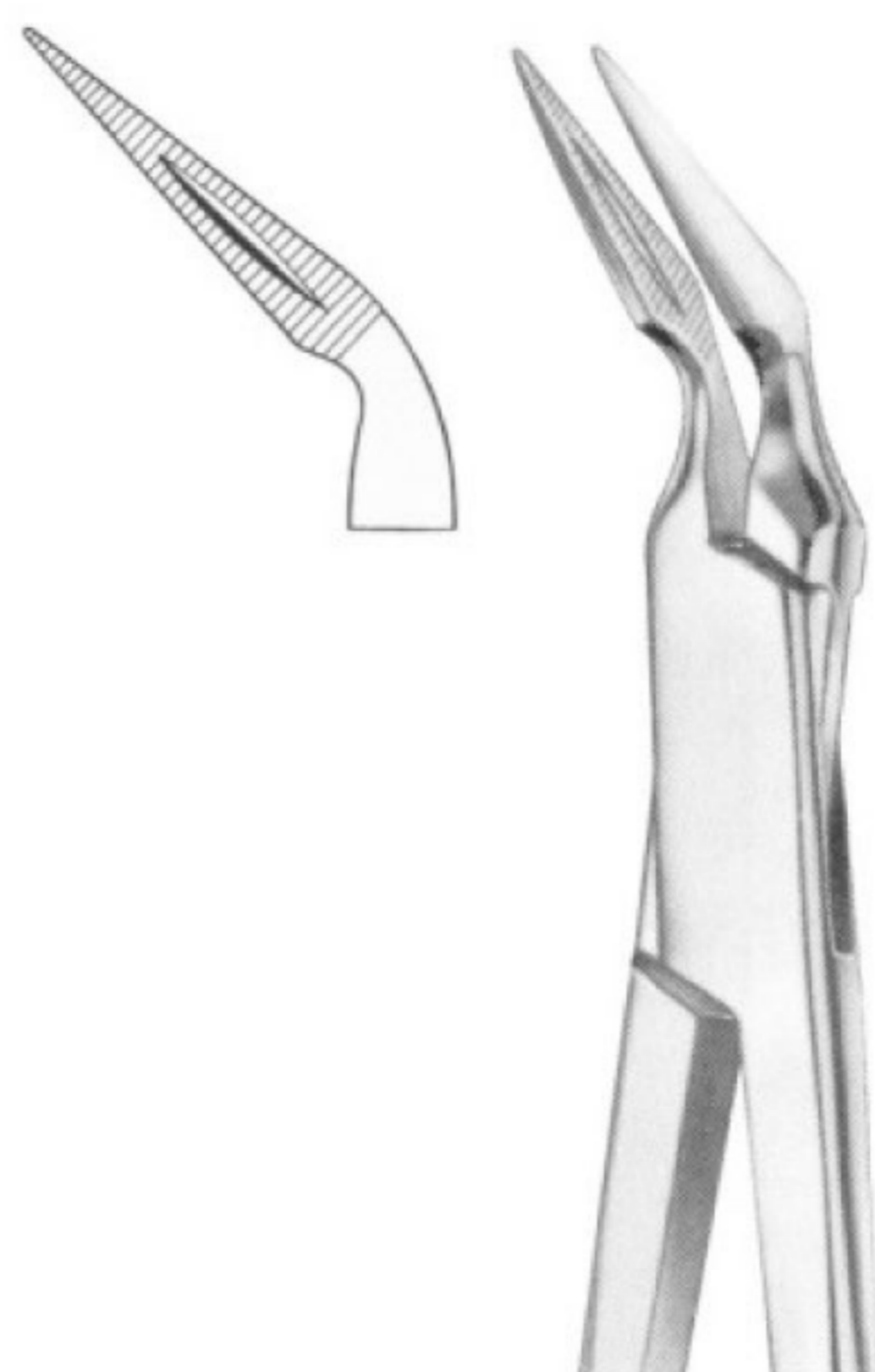

STIEGLITZ Fig. 230 root fragments
MWD-1220
 STIEGLITZ Fig. 230 root fragments



RALK Fig. 231 root fragments
MWD-1221
 RALK Fig. 231 root fragments



W1-WINTER upper centrals and canines
MWD-1222
 W1-WINTER upper centrals and canines

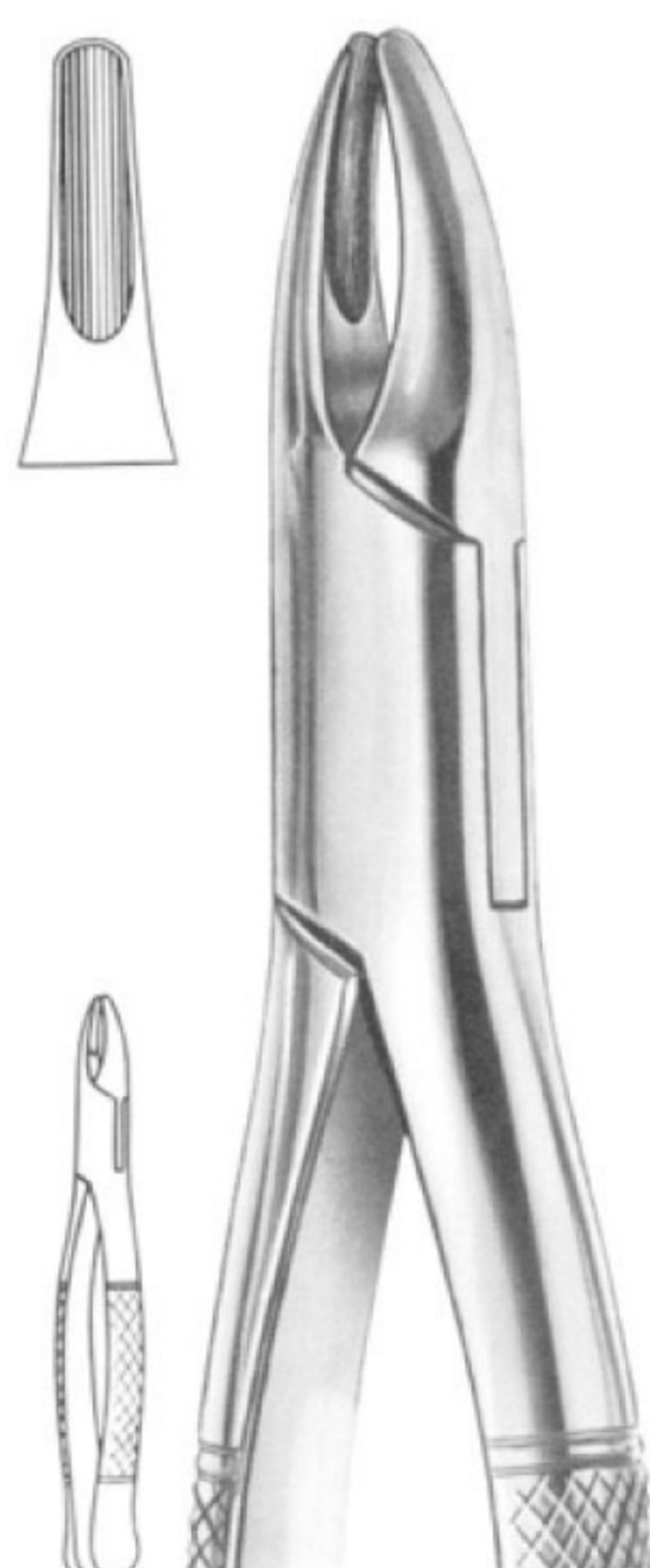

Fig. 1 upper incisors and roots
MWD-1223
 Fig. 1 upper incisors and roots

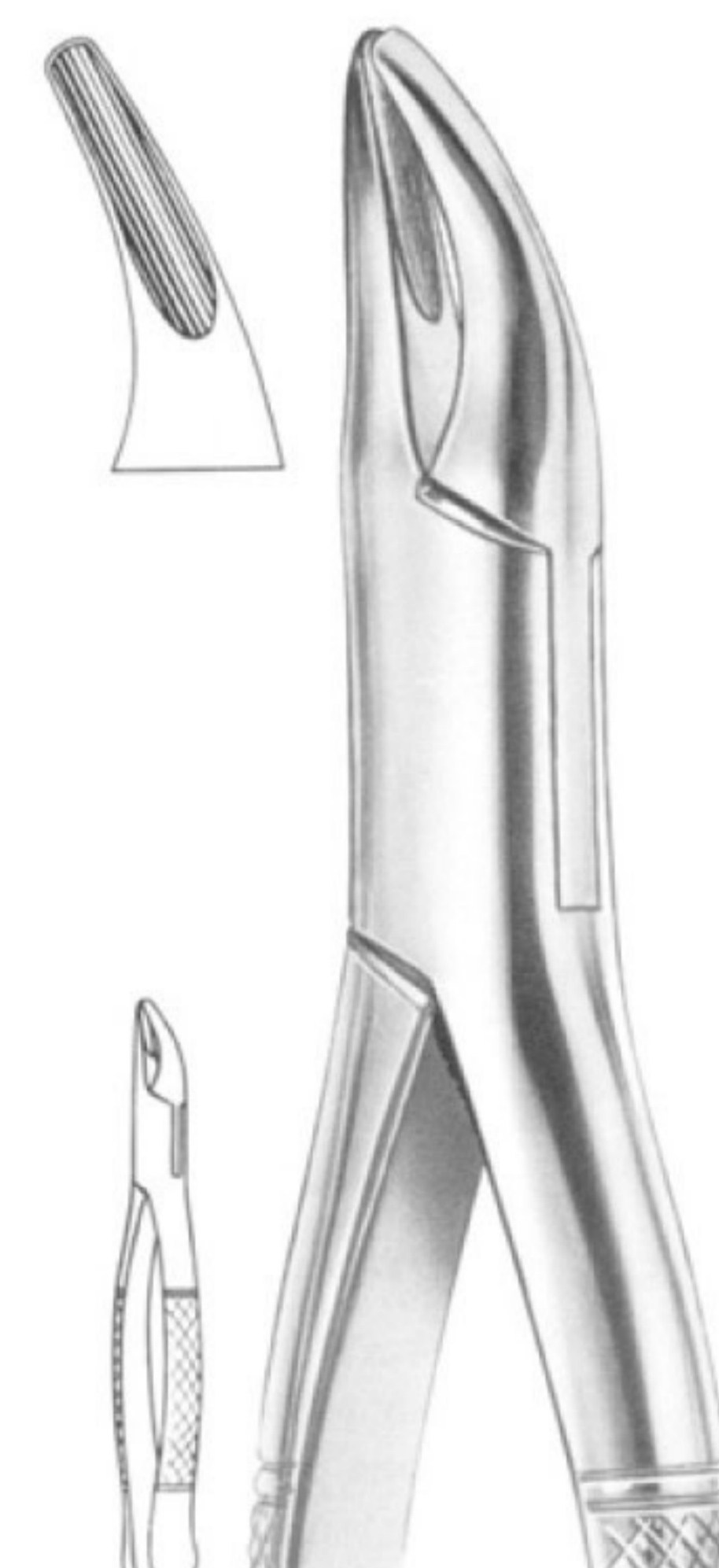

Fig. 2 upper and lower roots
MWD-1224
 Fig. 2 upper and lower roots

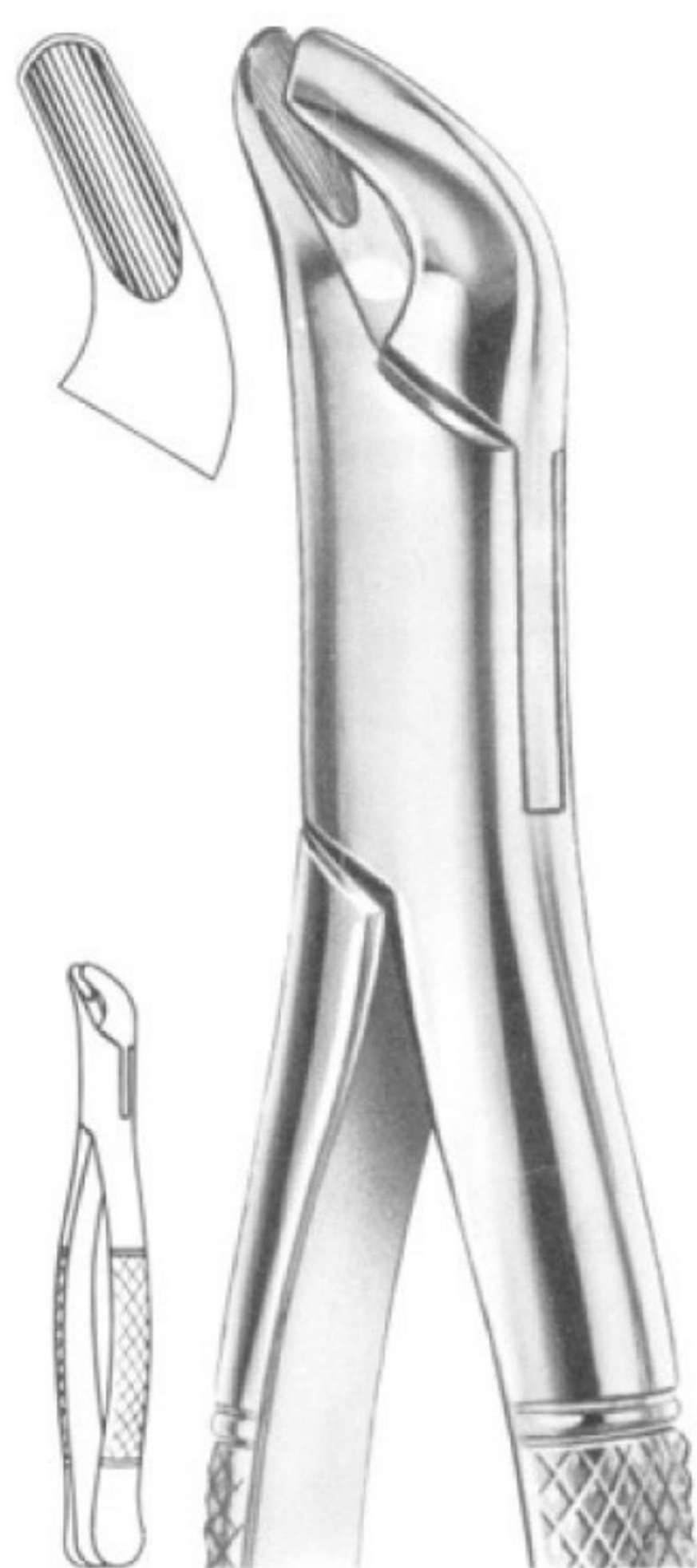
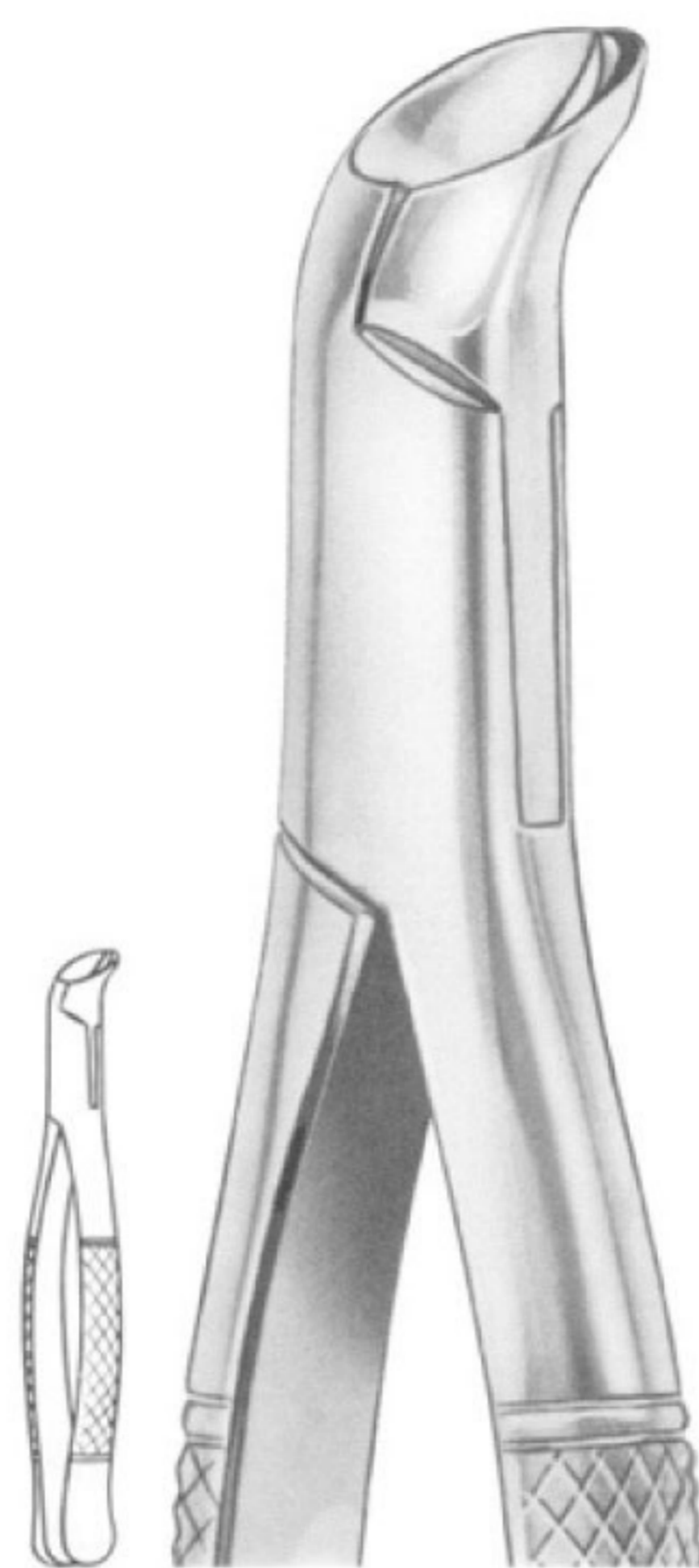

Fig. 4 upper and lower premolars
MWD-1225
 Fig. 4 upper and lower premolars



PHYSICK Fig. 5 lower third molars
MWD-1226
 PHYSICK Fig. 5 lower third molars



Fig. 6 separating forceps
MWD-1227
 Fig. 6 separating forceps



Fig. 7 upper roots
MWD-1228
 Fig. 7 upper roots

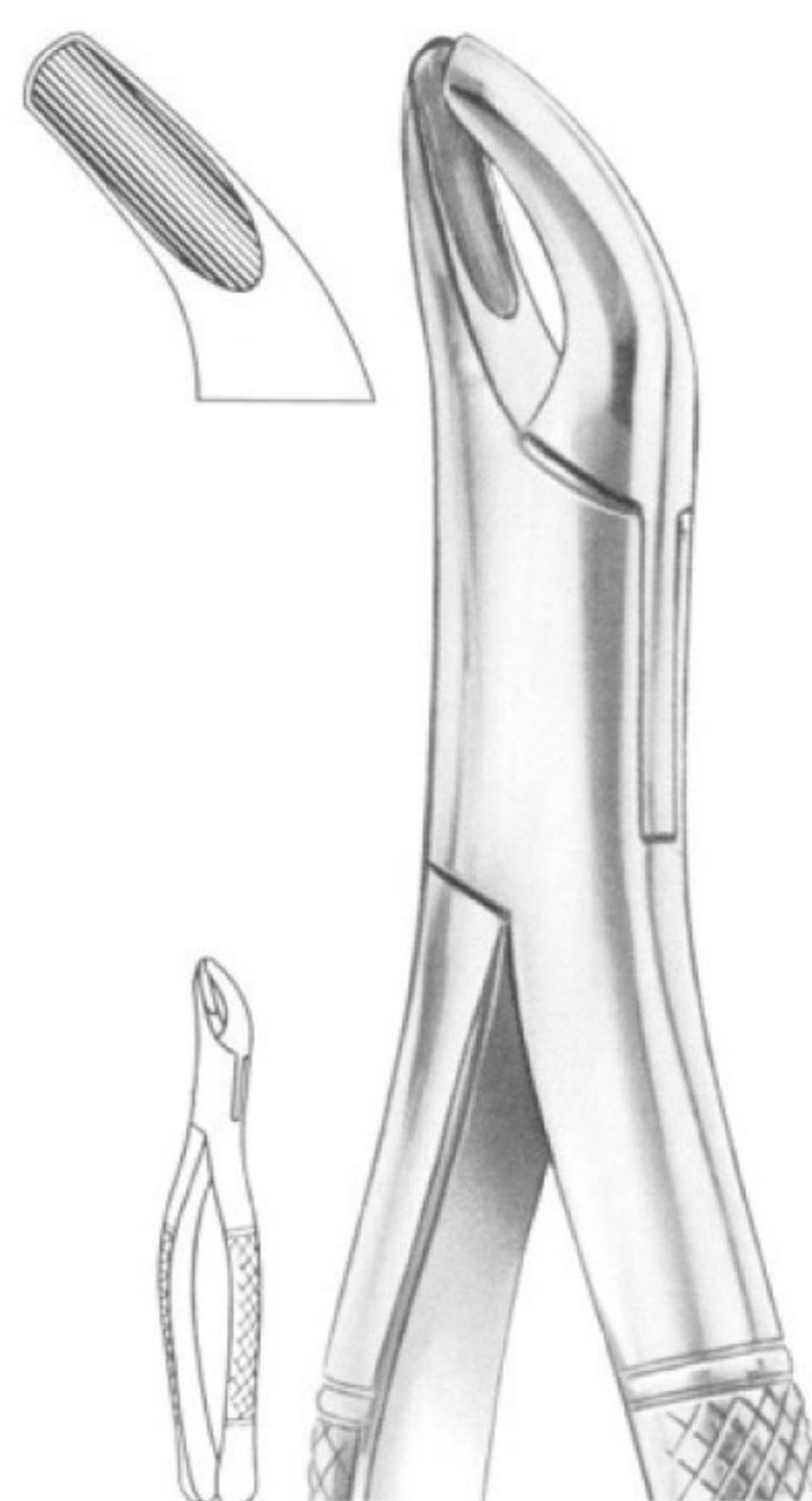

Fig. 8 upper and lower third molars
MWD-1229
 Fig. 8 upper and lower third molars

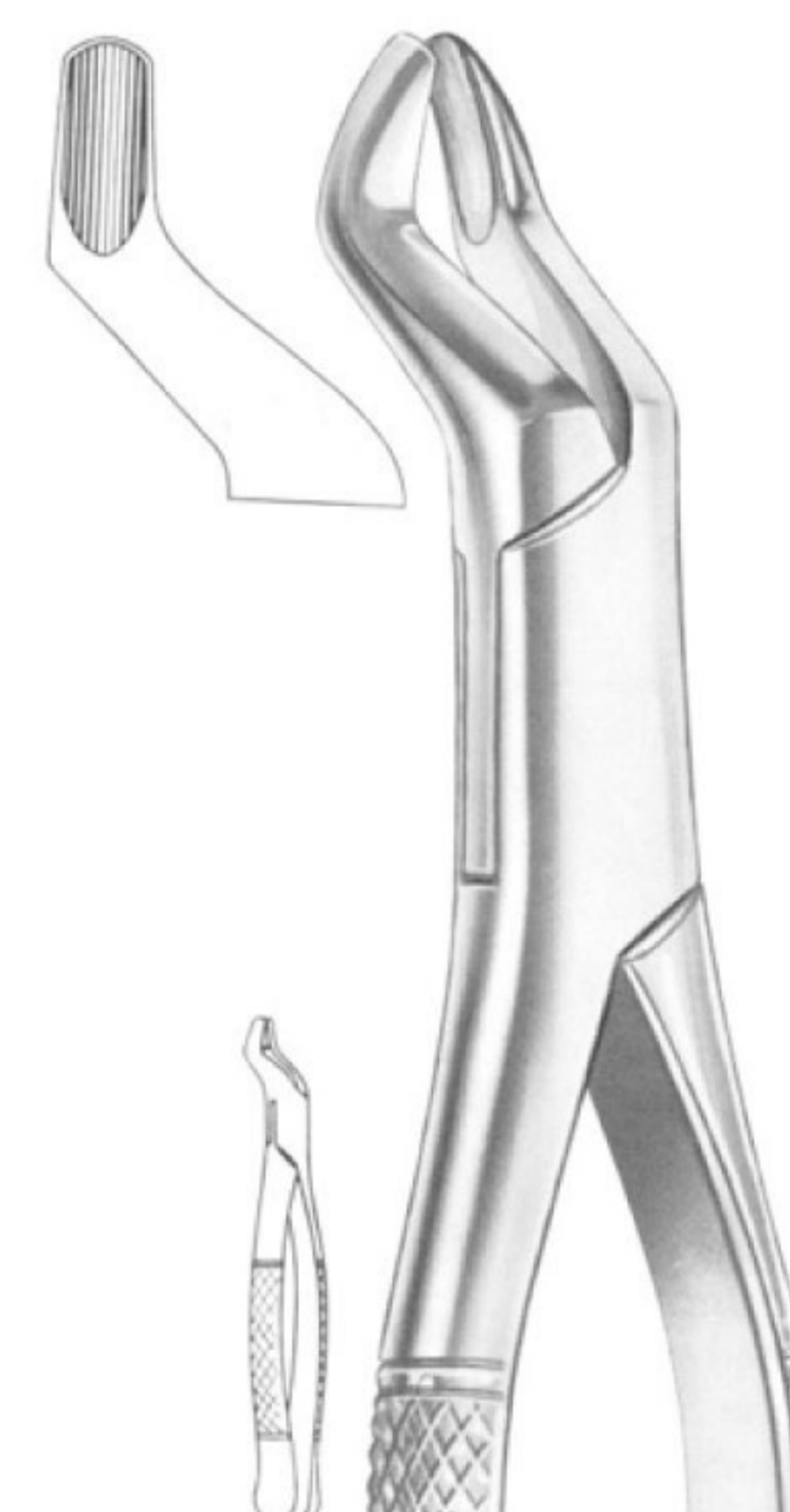

Fig. 10S upper molars
MWD-1230
 Fig. 10S upper molars



Fig. 10H upper molars
MWD-1231
Fig. 10H upper molars

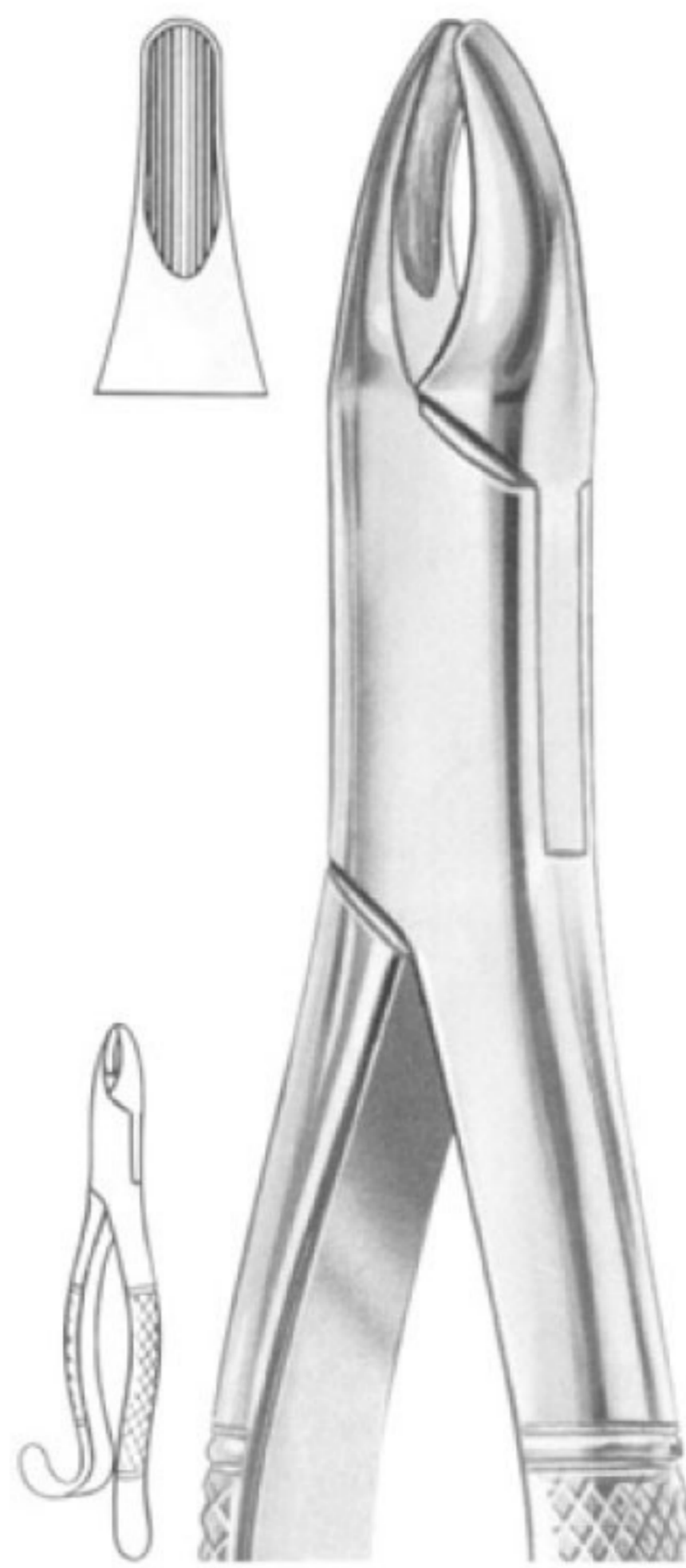

Fig. 13 upper incisors
MWD-1232
Fig. 13 upper incisors

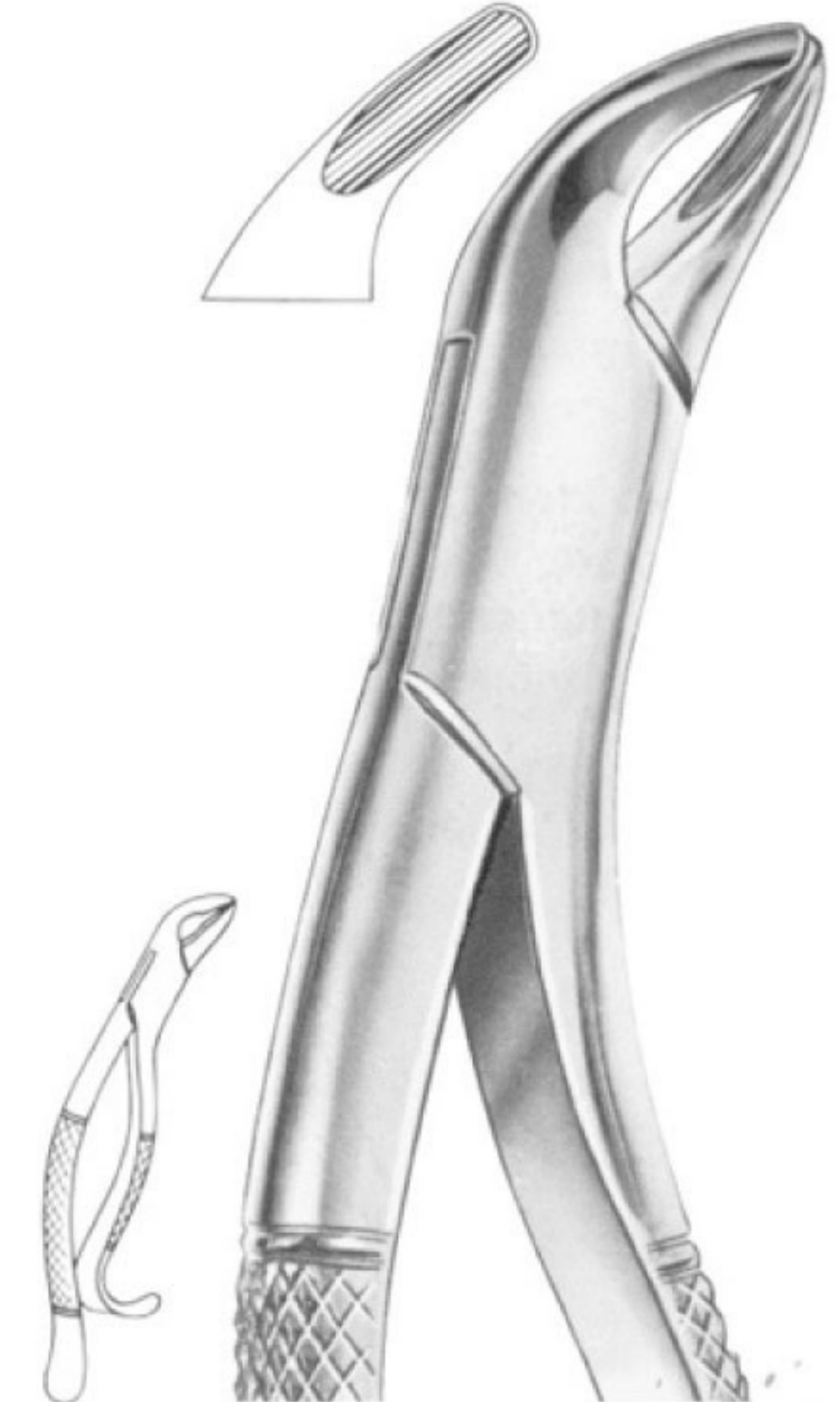

Fig. 14 lower incisors
MWD-1233
Fig. 14 lower incisors



Fig. 16 lower molars
MWD-1234
Fig. 16 lower molars



HARRIS Fig. 15 lower molars
MWD-1235
HARRIS Fig. 15 lower molars

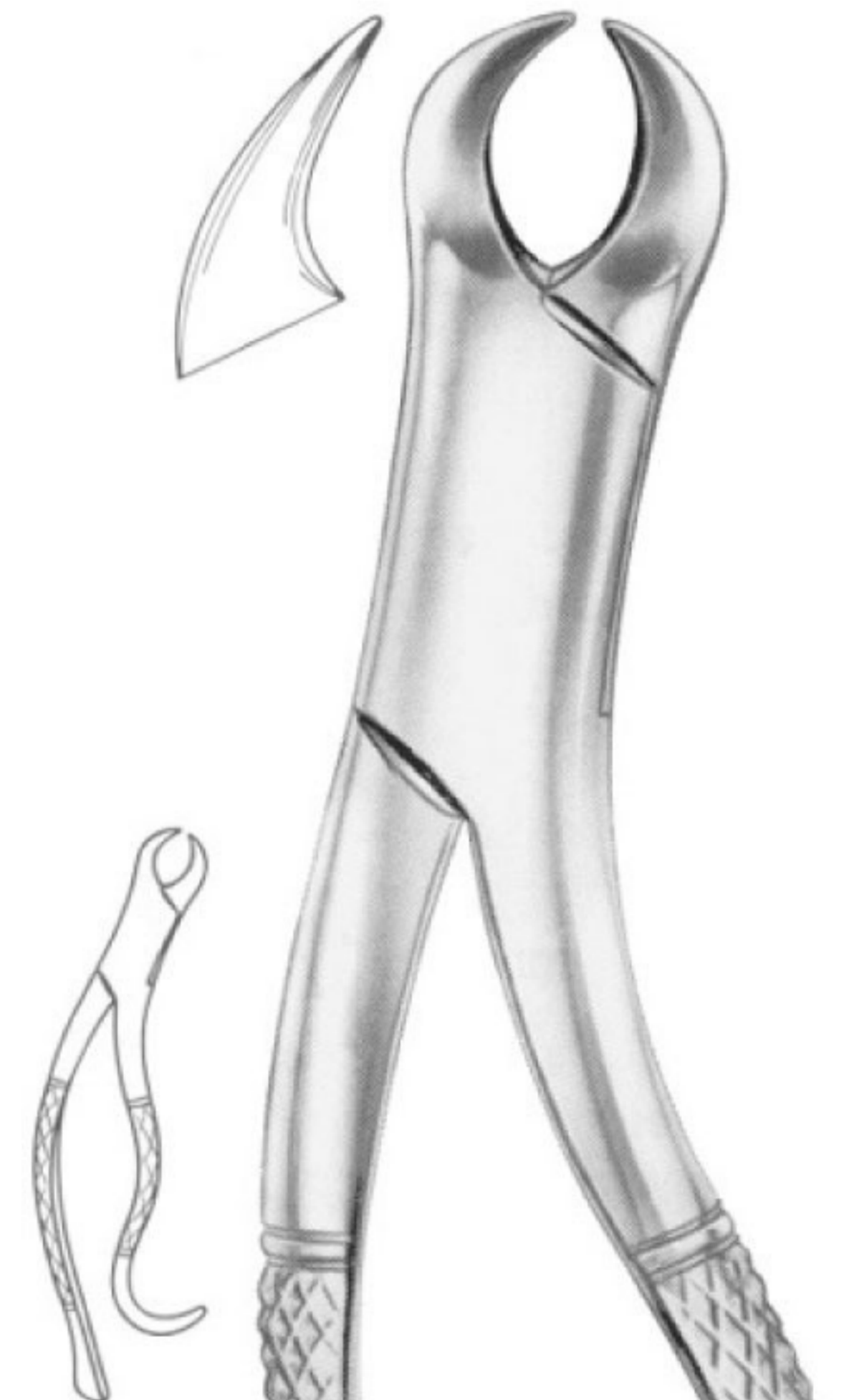

Fig. 16S lower molars for children
MWD-1236
Fig. 16S lower molars for children



HARRIS Fig. 18R upper molars right
MWD-1237
 HARRIS Fig. 18R upper molars right



HARRIS Fig. 18L upper molars left
MWD-1238
 HARRIS Fig. 18L upper molars left

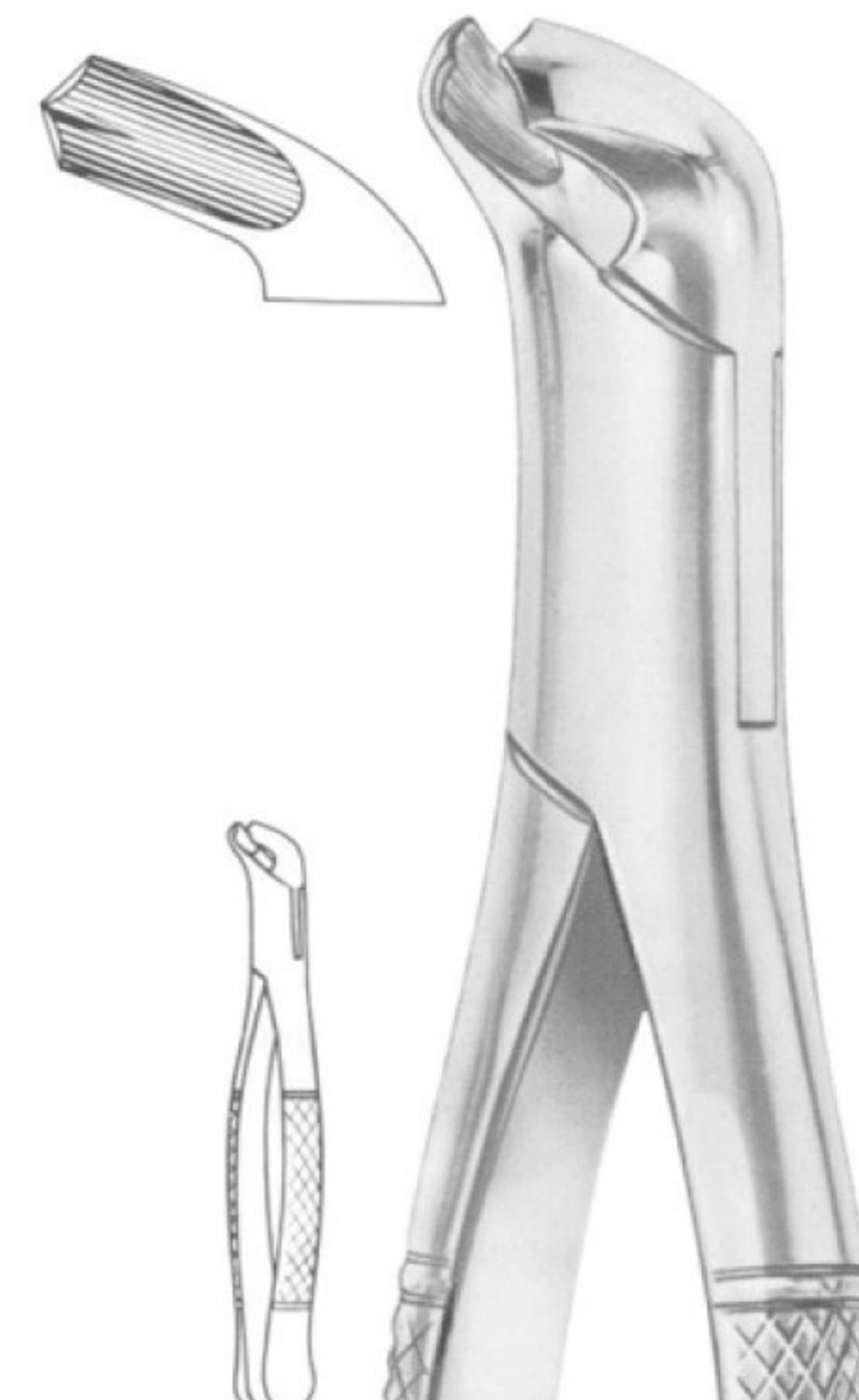

Fig. 17 lower molars
MWD-1239
 Fig. 17 lower molars



Fig. 20R upper molars right
MWD-1240
 Fig. 20R upper molars right



Fig. 20L upper molars left
MWD-1241
 Fig. 20L upper molars left



Fig. 23 lower molars
MWD-1242
 Fig. 23 lower molars

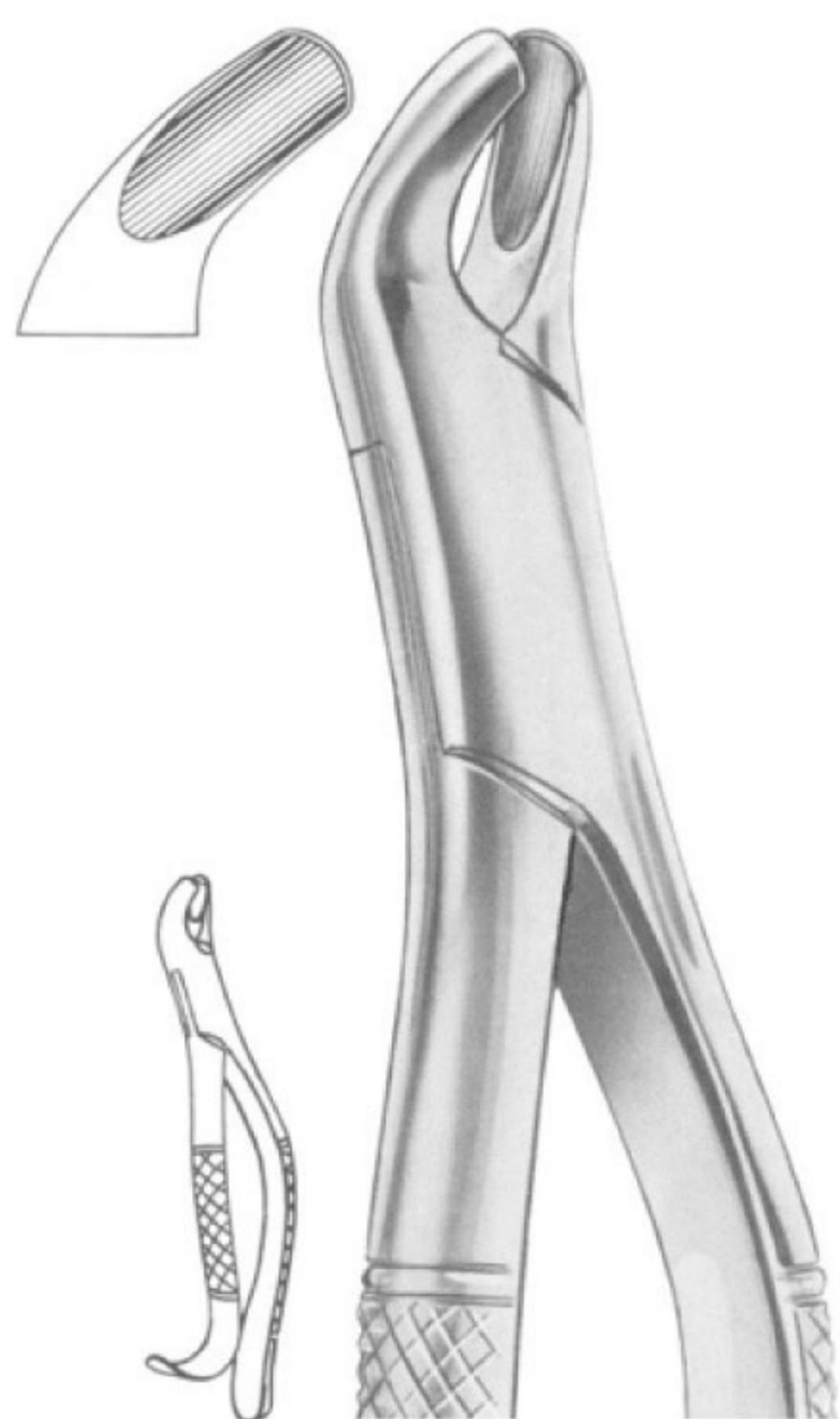

Fig. 24 upper molars
MWD-1243
Fig. 24 upper molars

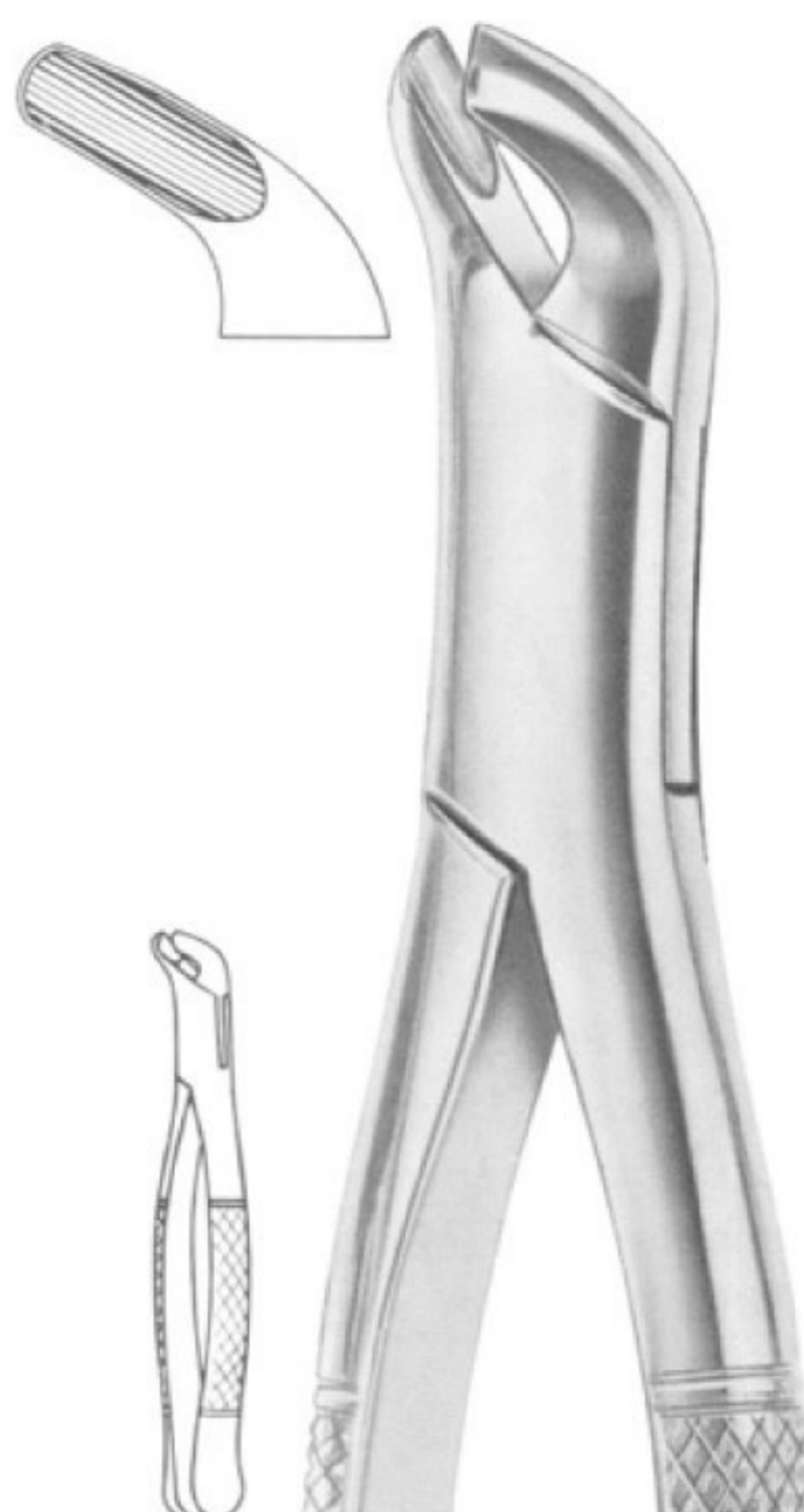

Fig. 27 lower molars
MWD-1244
Fig. 27 lower molars



Fig. 29S lower teeth for children
MWD-1245
Fig. 29S lower teeth for children



Fig. 30S upper teeth for children
MWD-1246
Fig. 30S upper teeth for children



PARMLY Fig. 32 upper premolars and molars
MWD-1247
PARMLY Fig. 32 upper premolars and molars

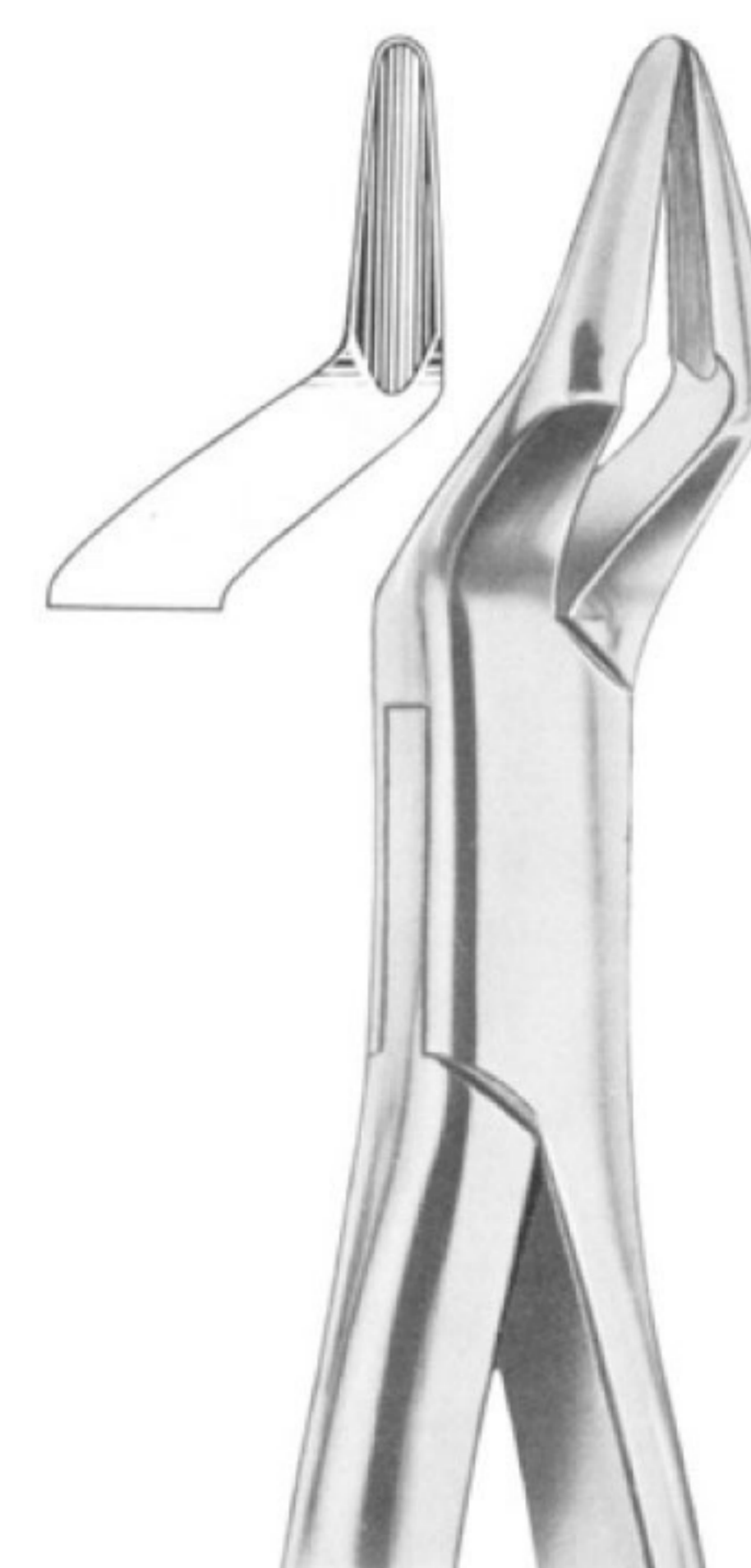

PARMLY Fig. 32A upper premolars and roots
MWD-1248
PARMLY Fig. 32A upper premolars and roots



Fig. 34 lower anteriors and roots
MWD-1249
Fig. 34 lower anteriors and roots

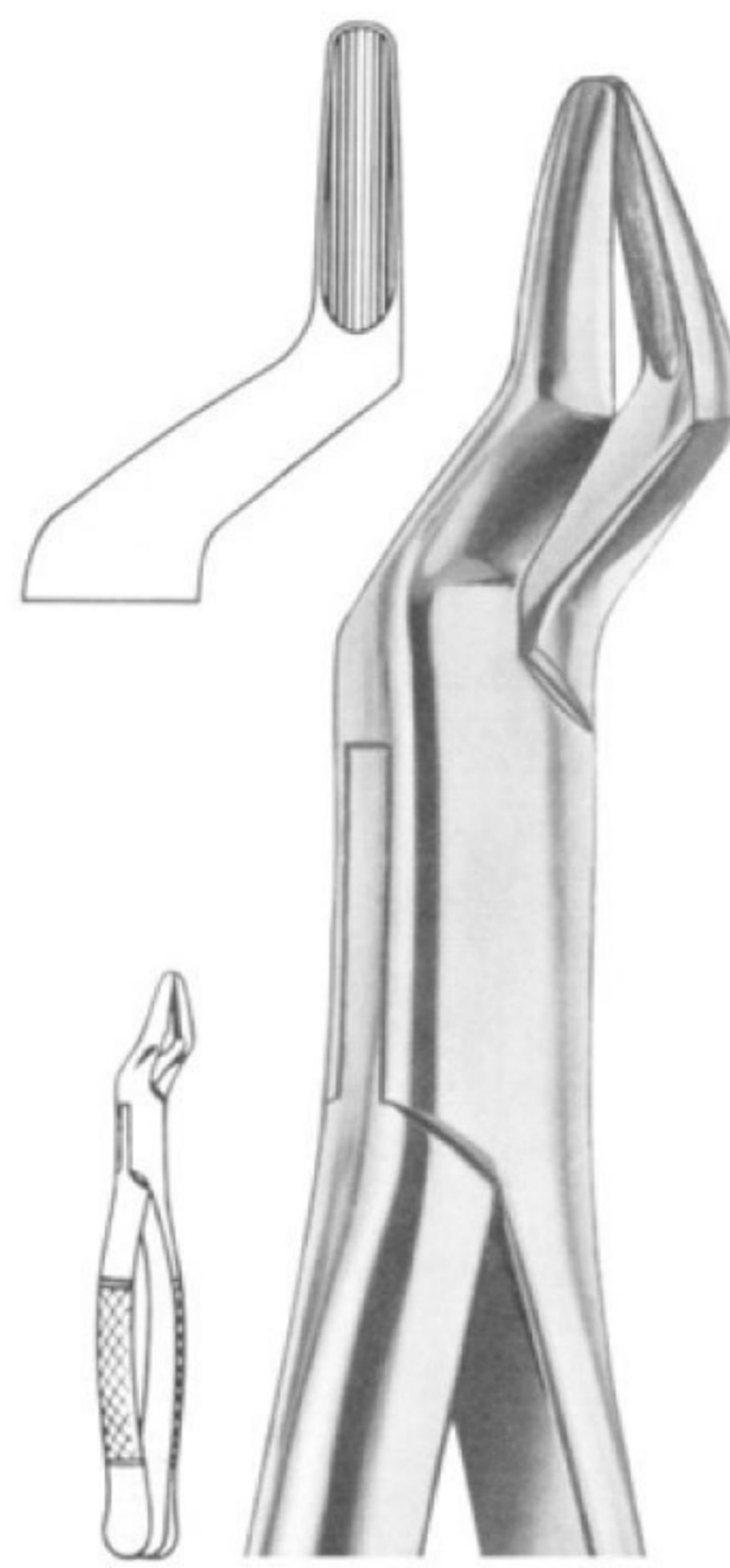

Fig. 35 upper roots
MWD-1250
Fig. 35 upper roots

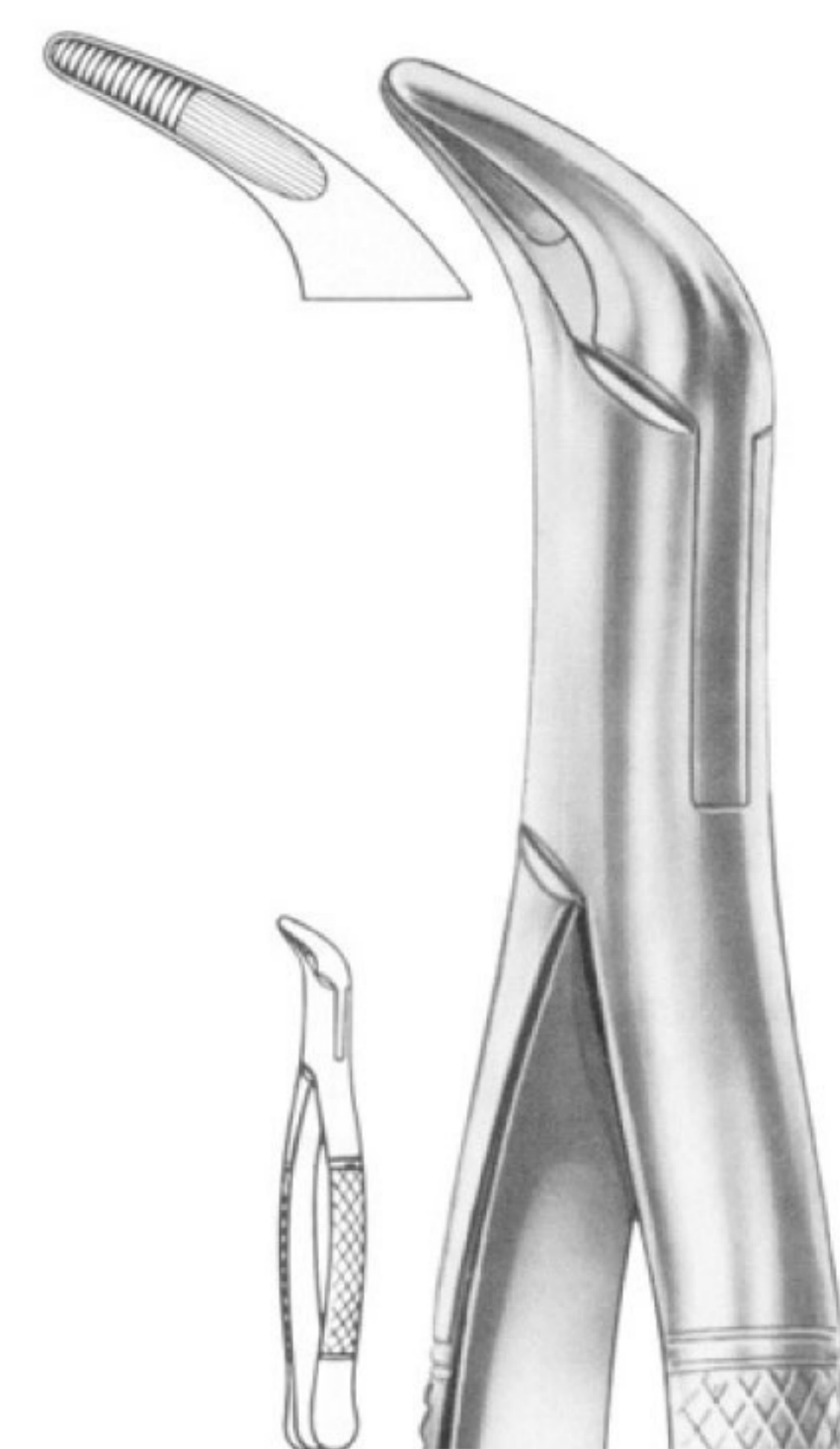

Fig. 36 lower anteriors and roots
MWD-1251
Fig. 36 lower anteriors and roots



Fig. 37 lower anteriors and roots
MWD-1252
Fig. 37 lower anteriors and roots

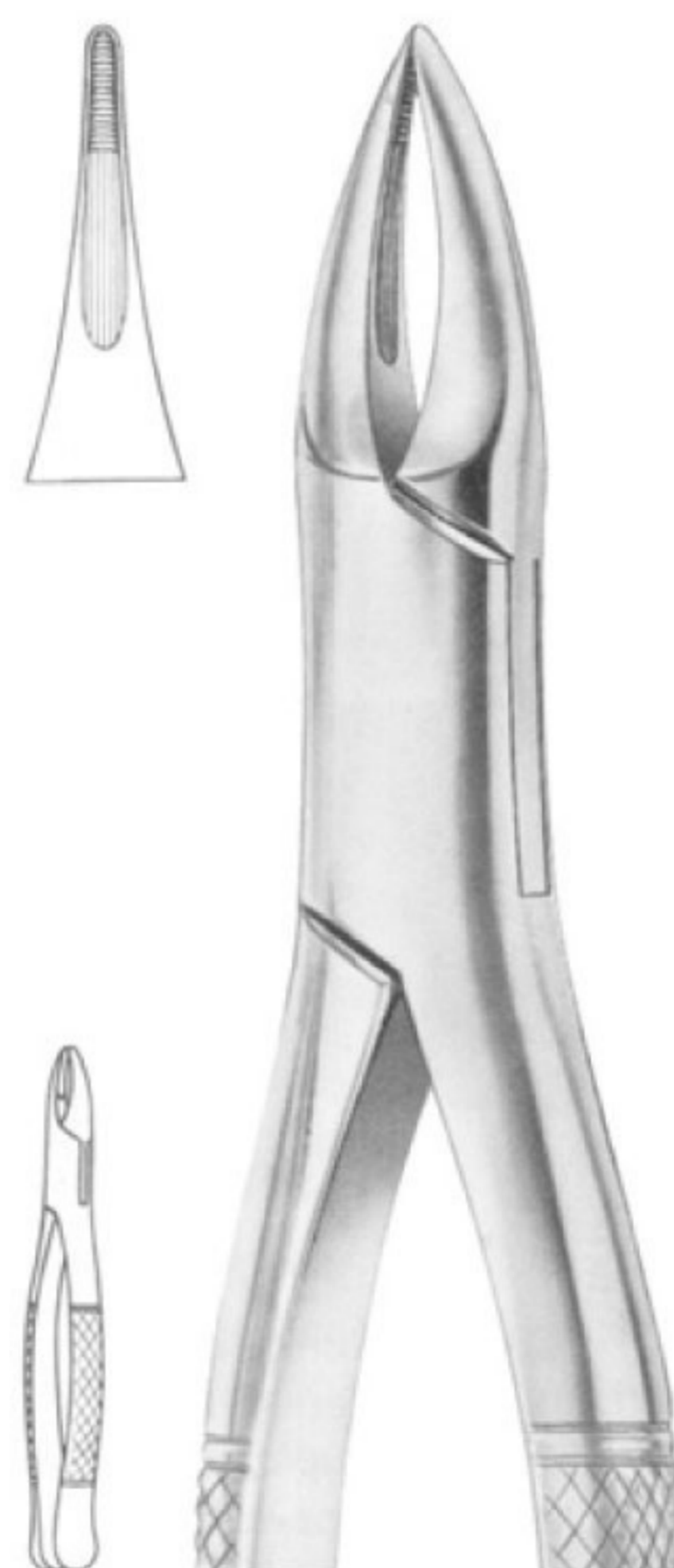

Fig. 38 upper anteriors and roots
MWD-1253
Fig. 38 upper anteriors and roots



Fig. 53R upper molars right
MWD-1254
Fig. 53R upper molars right



**Fig. 53L upper molars left
MWD-1255**
Fig. 53L upper molars left

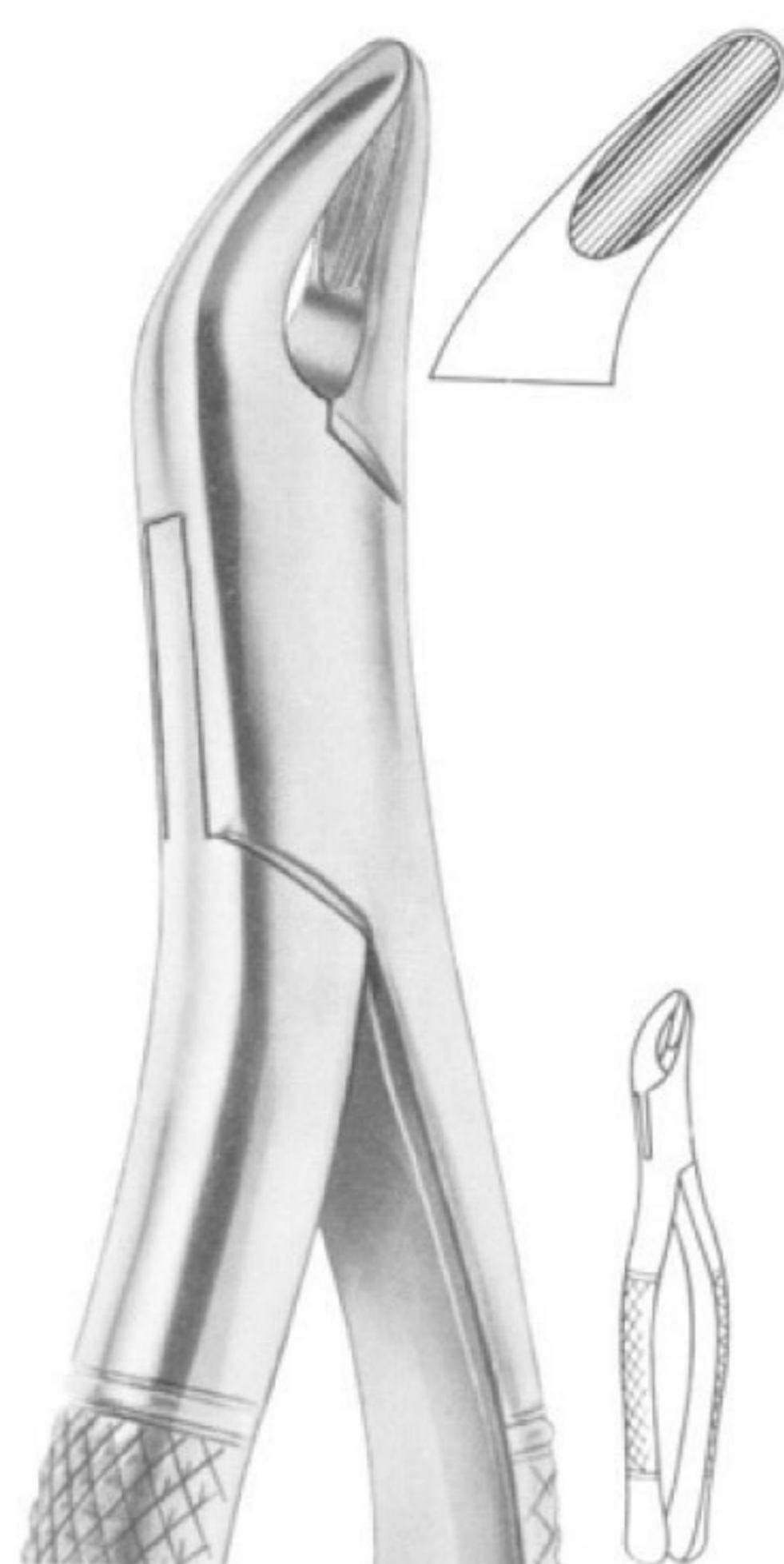

**Fig. 62 incisors, premolars, deciduous
teeth
MWD-1256**
Fig. 62 incisors, premolars, deciduous teeth



**Fig. 65 upper incisors and roots
MWD-1257**
Fig. 65 upper incisors and roots



**TOMES Fig. 69 upper and lower roots
MWD-1258**
TOMES Fig. 69 upper and lower roots



**TOMES Fig. 85 lower canines, premolars
and molars
MWD-1259**
TOMES Fig. 85 lower canines, premolars
and molars

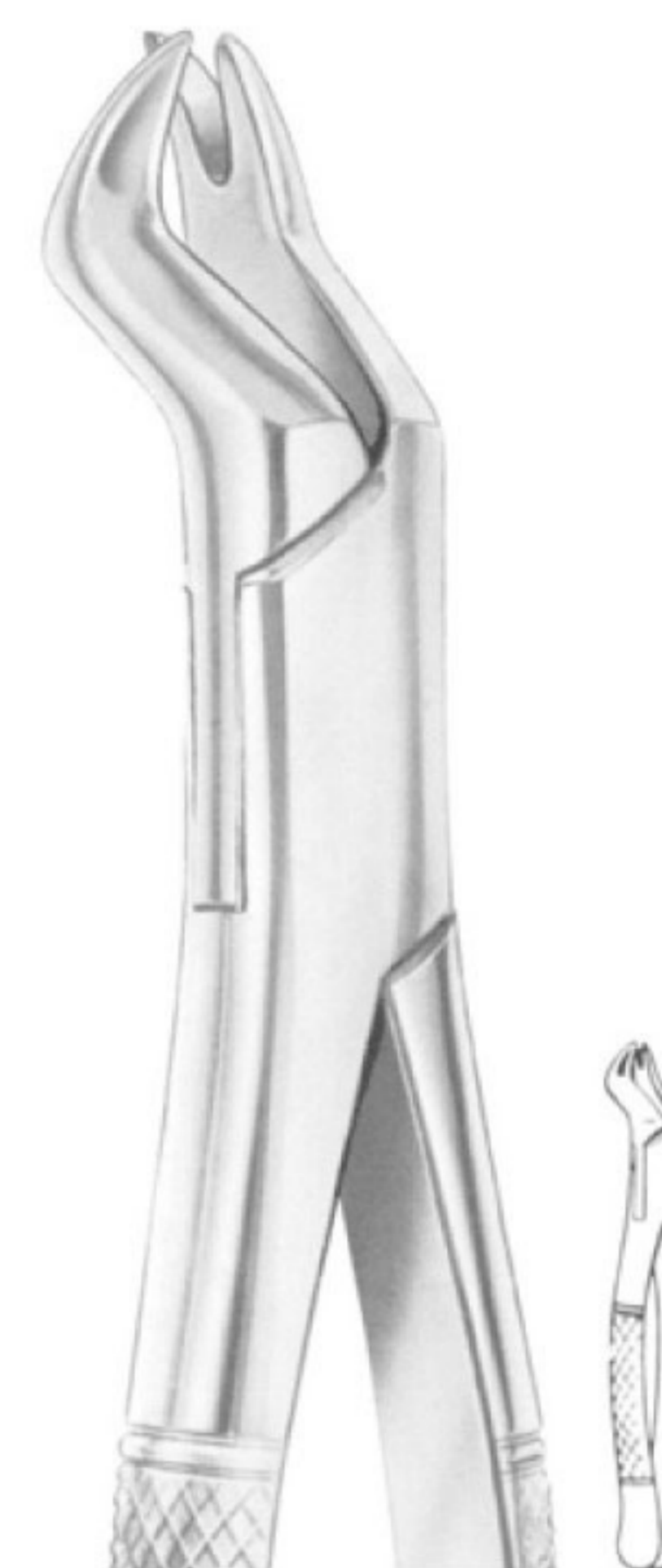

**NEVIUS Fig. 88R upper molars right
MWD-1260**
NEVIUS Fig. 88R upper molars right



THOMAS Fig. 85A lower canines, premolars and molars
MWD-1261

THOMAS Fig. 85A lower canines, premolars and molars



NEVIUS Fig. 88L upper molars left
MWD-1262

NEVIUS Fig. 88L upper molars left



KELLS Fig. 99A upper incisors, canines, premolars
MWD-1263

KELLS Fig. 99A upper incisors, canines, premolars



Fig. 104 upper third molars
MWD-1264

Fig. 104 upper third molars

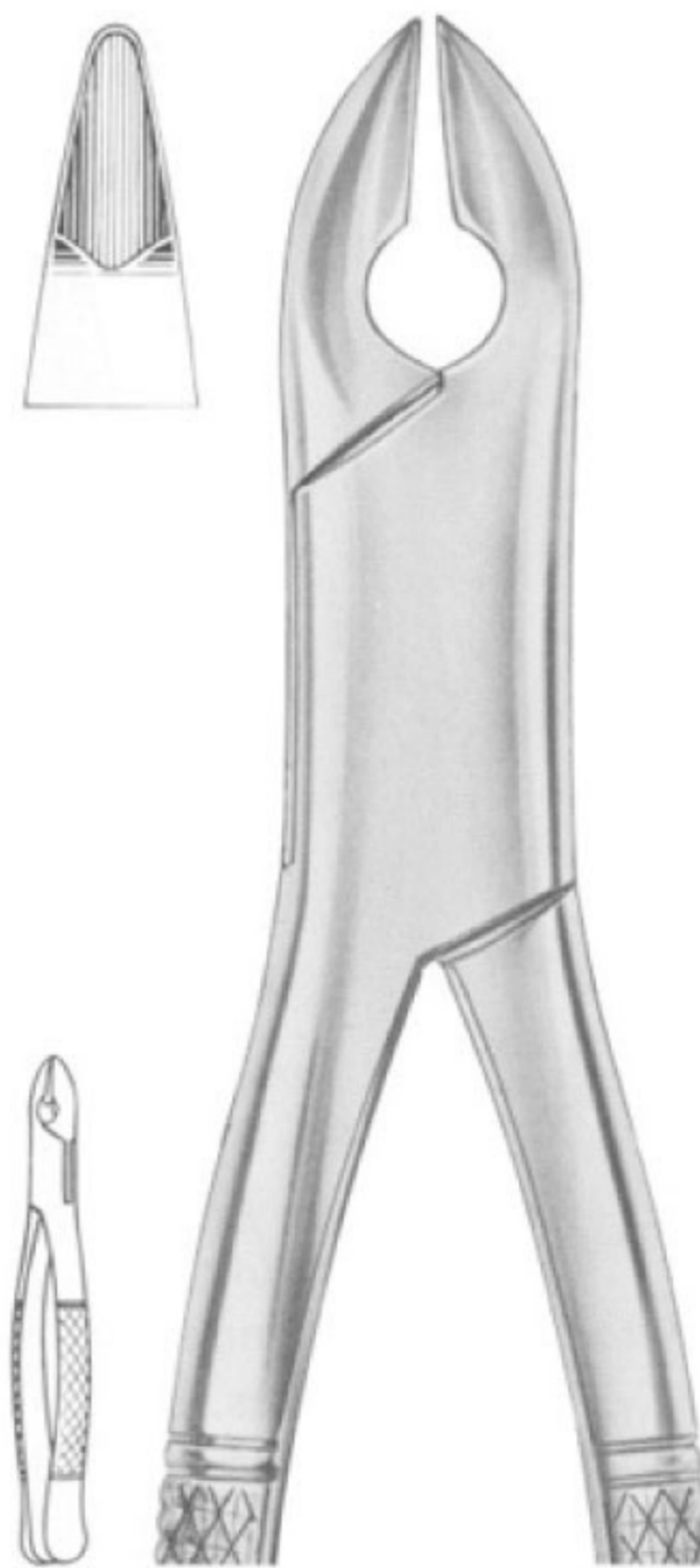

KELLS Fig. 99C upper incisors, canines, premolars
MWD-1265

KELLS Fig. 99C upper incisors, canines, premolars



HULL Fig. 101 deciduous teeth
MWD-1266

HULL Fig. 101 deciduous teeth



Fig. 103 lower incisors, premolars
MWD-1267

Fig. 103 lower incisors, premolars



CRYER Fig. 150 lower incisors, premolars, roots
MWD-1268

CRYER Fig. 150 lower incisors, premolars, roots



CRYER Fig. 150A upper incisors, premolars, roots
MWD-1269

CRYER Fig. 150A upper incisors, premolars, roots

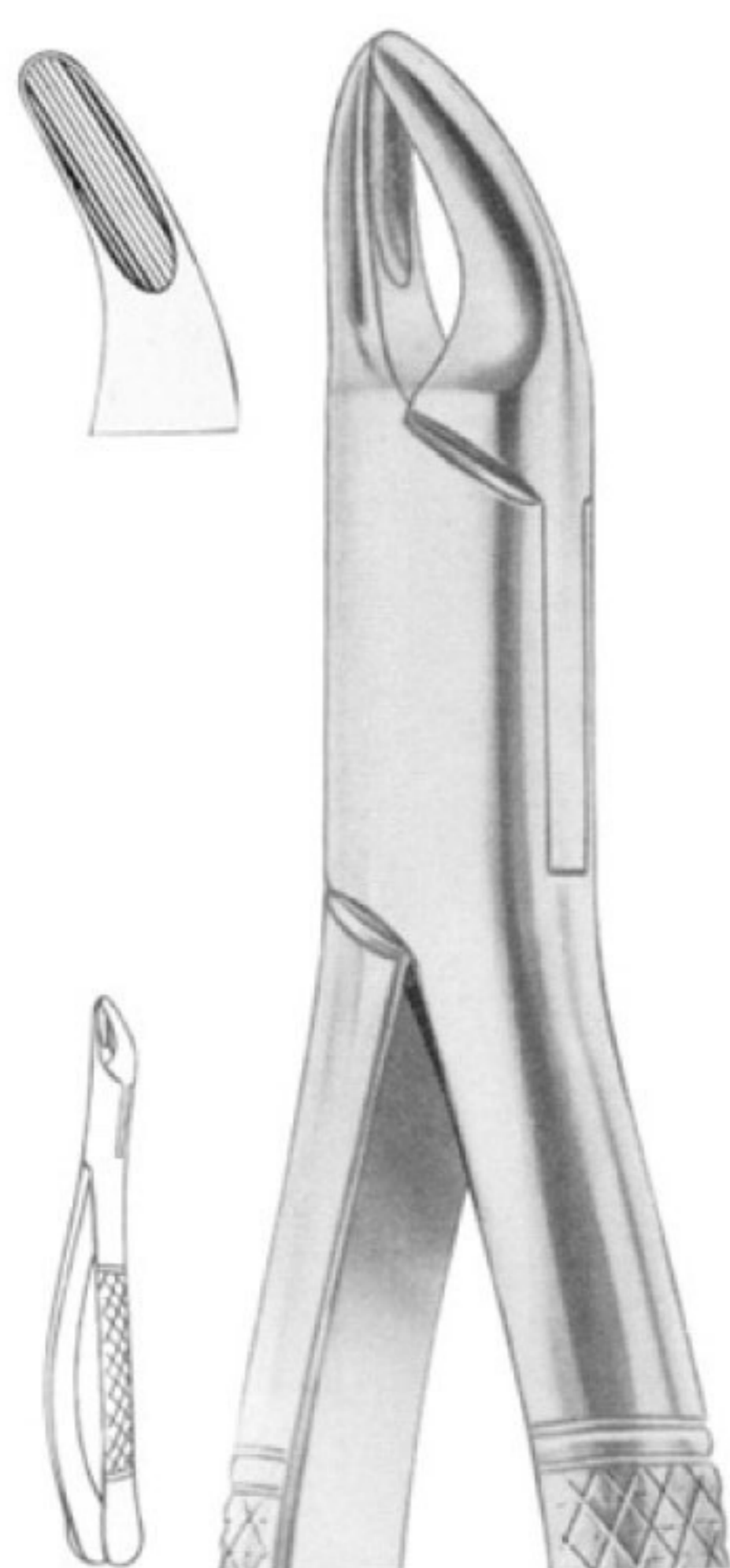

CRYER Fig. 150S upper teeth for children
MWD-1270

CRYER Fig. 150S upper teeth for children

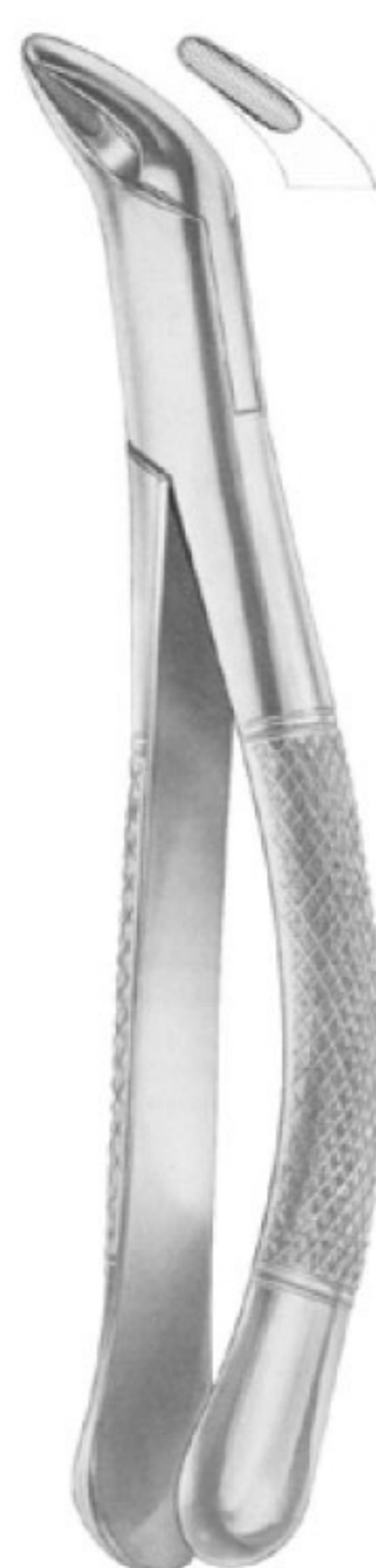

CRYER Fig. 151 lower incisors, premolars, roots
MWD-1271

CRYER Fig. 151 lower incisors, premolars, roots



CRYER Fig. 151A lower incisors, premolars, roots
MWD-1272

CRYER Fig. 151A lower incisors, premolars, roots

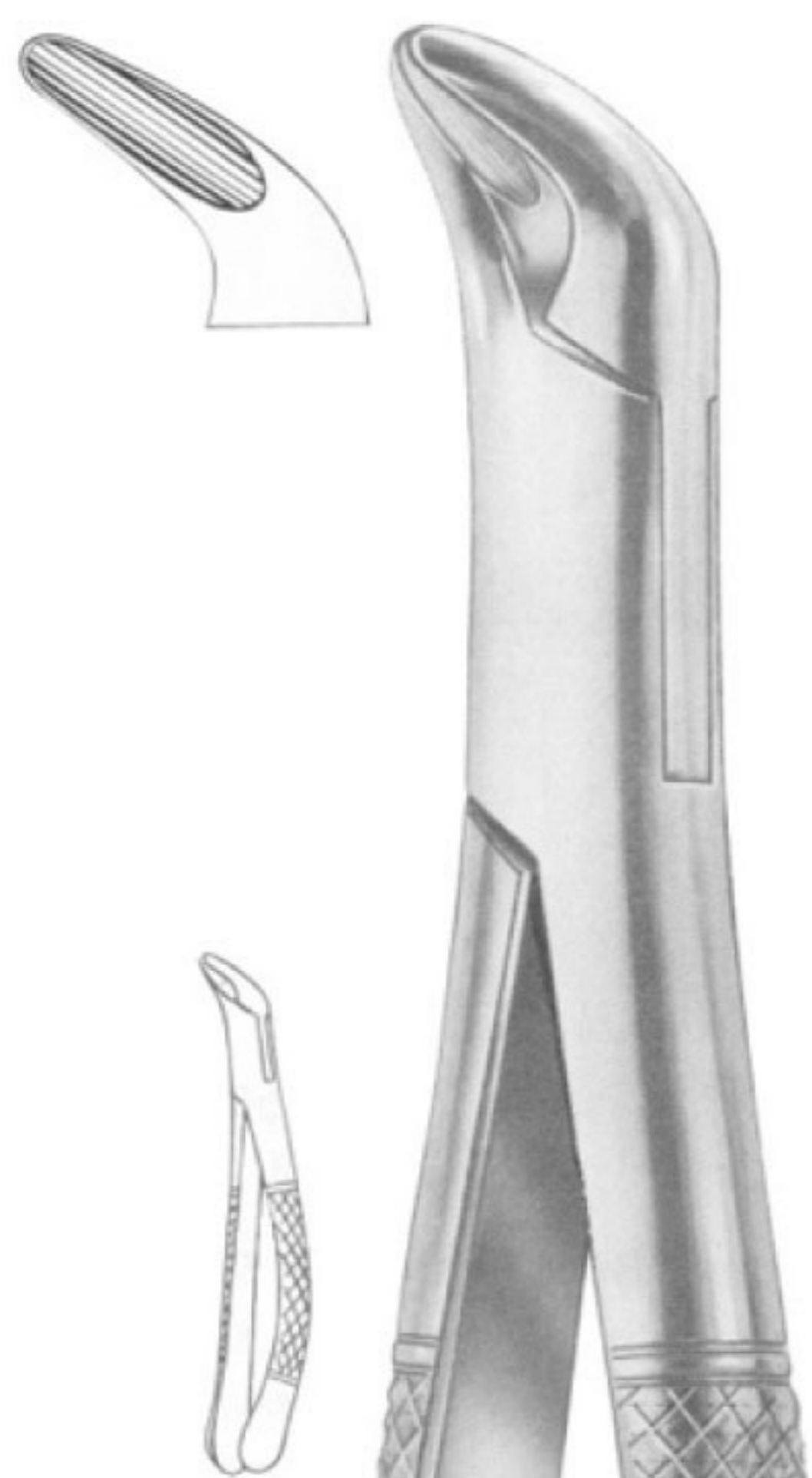

CRYER Fig. 151S lower teeth for children
MWD-1273
 CRYER Fig. 151S lower teeth for children



Fig. 203 lower incisors and roots
MWD-1274
 Fig. 203 lower incisors and roots



Fig. 210S upper third molars
MWD-1275
 Fig. 210S upper third molars



Fig. 201 upper incisors, canines, premolars
MWD-1276

Fig. 201 upper incisors, canines, premolars



Fig. 210H upper third molars
MWD-1277

Fig. 210H upper third molars



Fig. 213 upper centrals and canines
MWD-1278

Fig. 213 upper centrals and canines

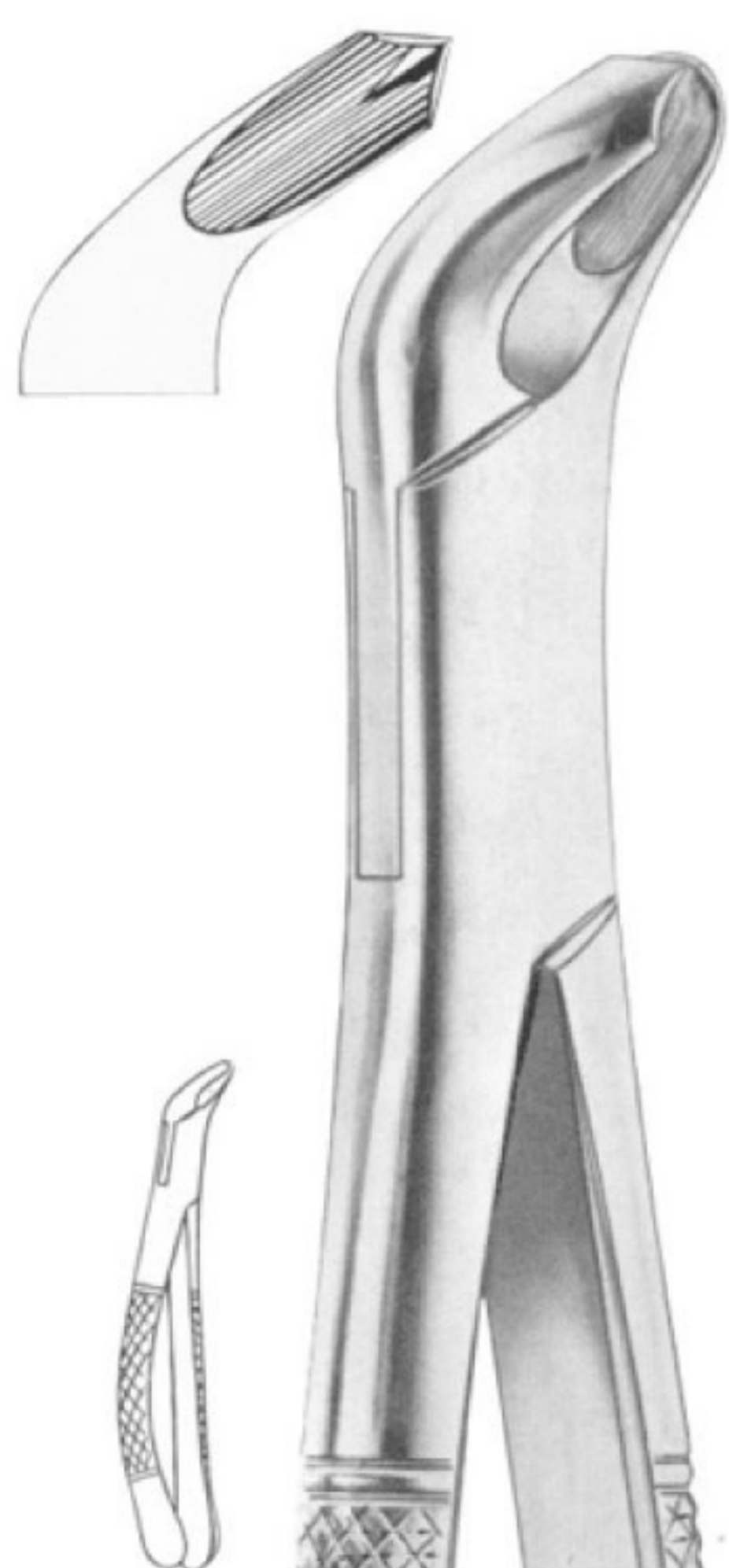

Fig. 217 lower molars
MWD-1279
Fig. 217 lower molars

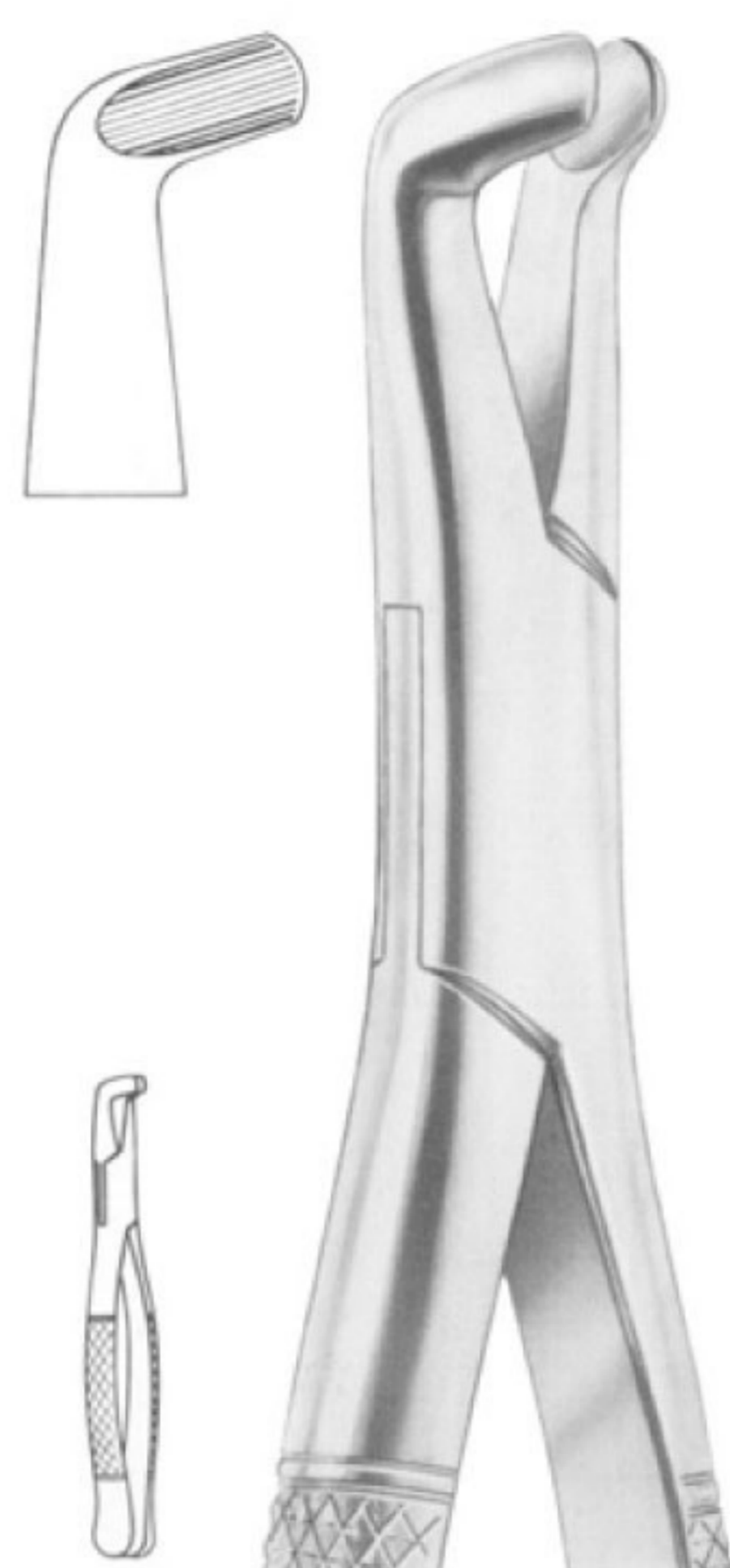

Fig. 222 lower third molars
MWD-1280
Fig. 222 lower third molars

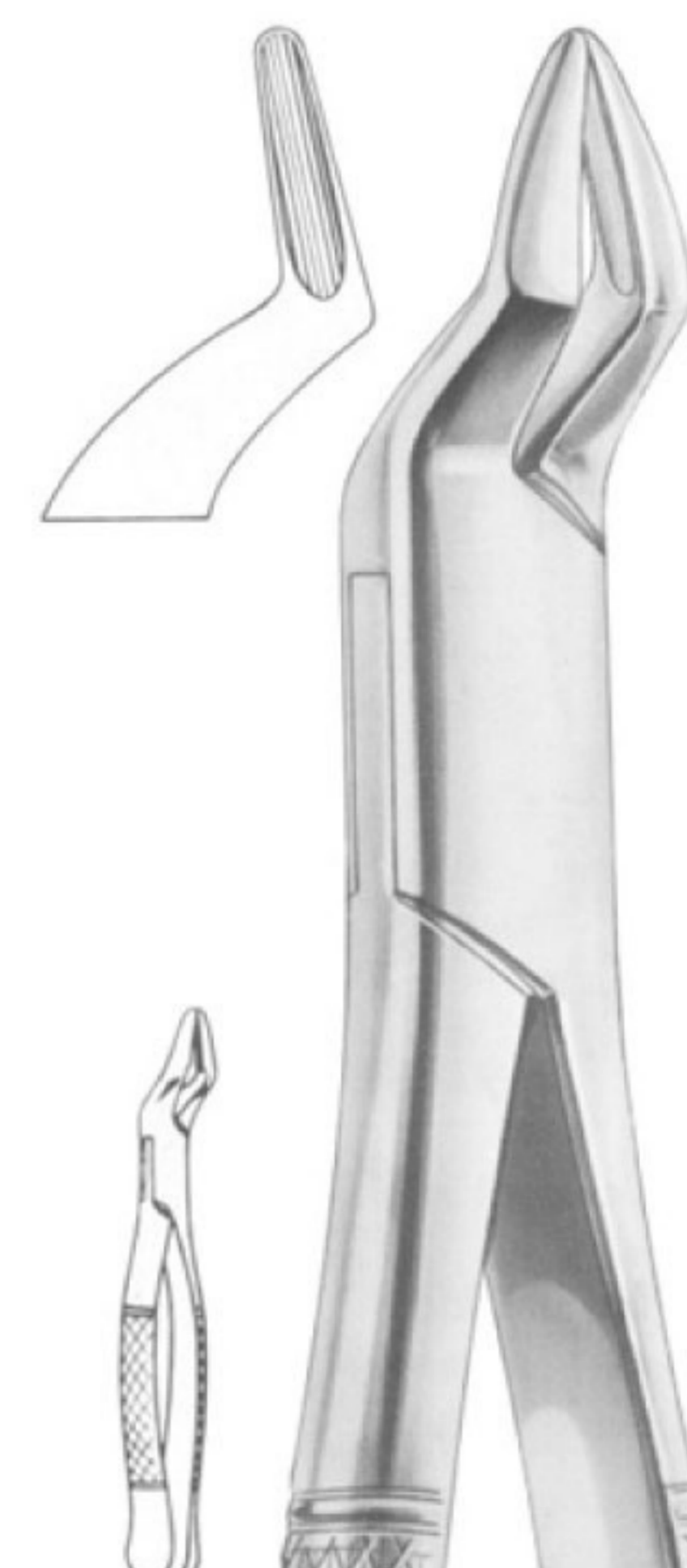

Fig. 286 upper incisors and roots
MWD-1281
Fig. 286 upper incisors and roots



Fig. 286 Swing lower molars
MW-1282
Fig. 286 Swing lower molars



Fig. 288 lower canines and premolars
MWD-1283
Fig. 288 lower canines and premolars



COHEN Fig. 310 universal forceps
MWD-1284
COHEN Fig. 310 universal forceps

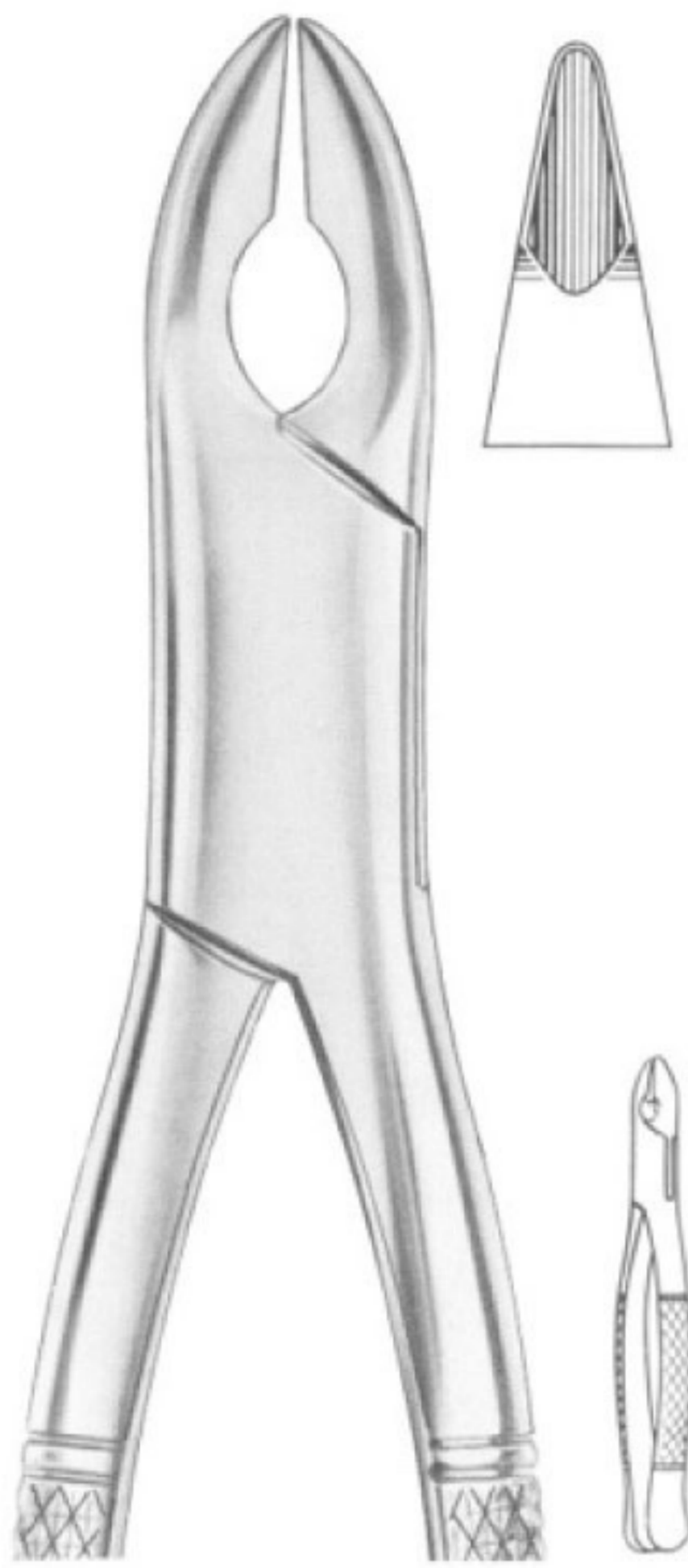

NEVIUS Fig. 320/10S upper canines
MWD-1285
 NEVIUS Fig. 320/10S upper canines

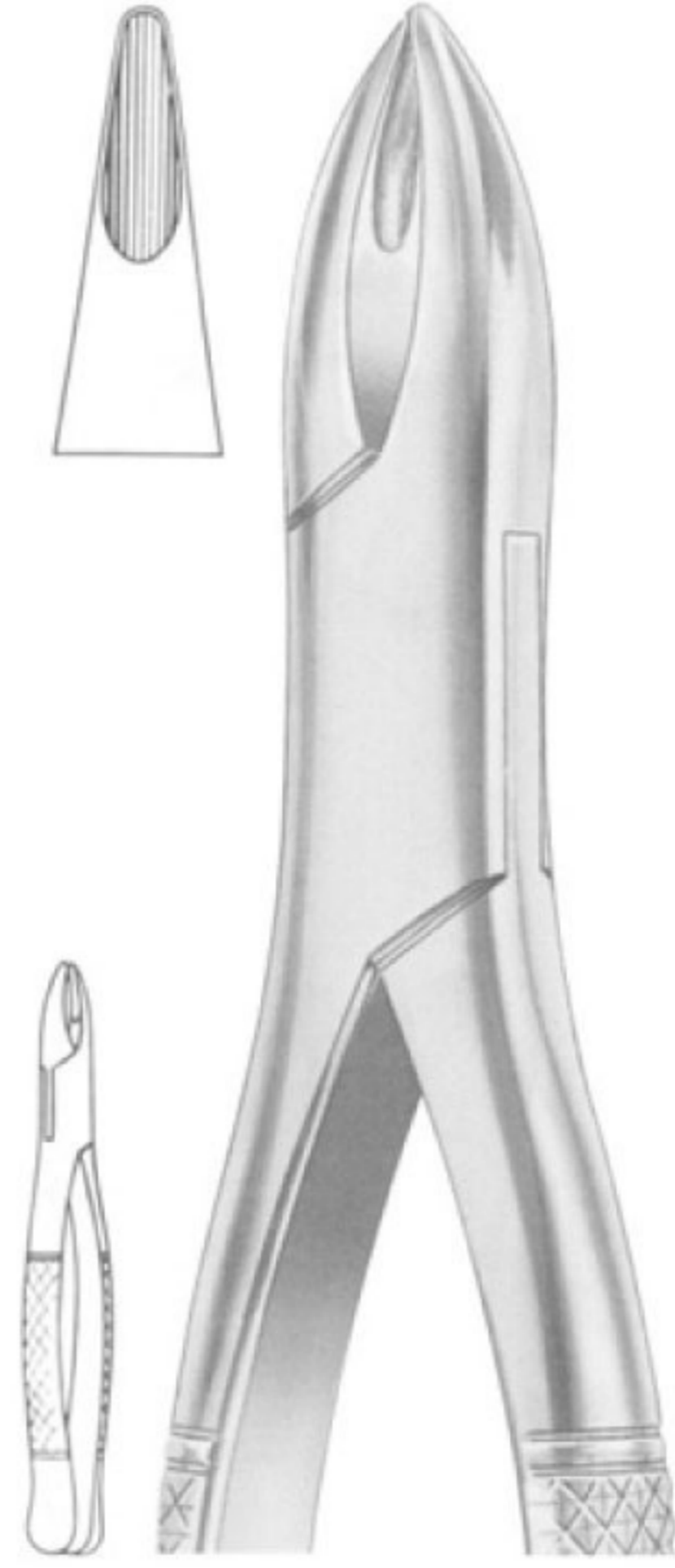

HENAHAN Fig. 315/1A upper incisors
MWD-1286
 HENAHAN Fig. 315/1A upper incisors



NEVIUS Fig. 325/10H upper canines
MWD-1287
 NEVIUS Fig. 325/10H upper canines



1288 STANDARD Fig. 330/4 upper third molars
MWD-1288
 1288 STANDARD Fig. 330/4 upper third molars



WOODWARD Fig. 335/FH lower molars
MWD-1289
 WOODWARD Fig. 335/FH lower molars

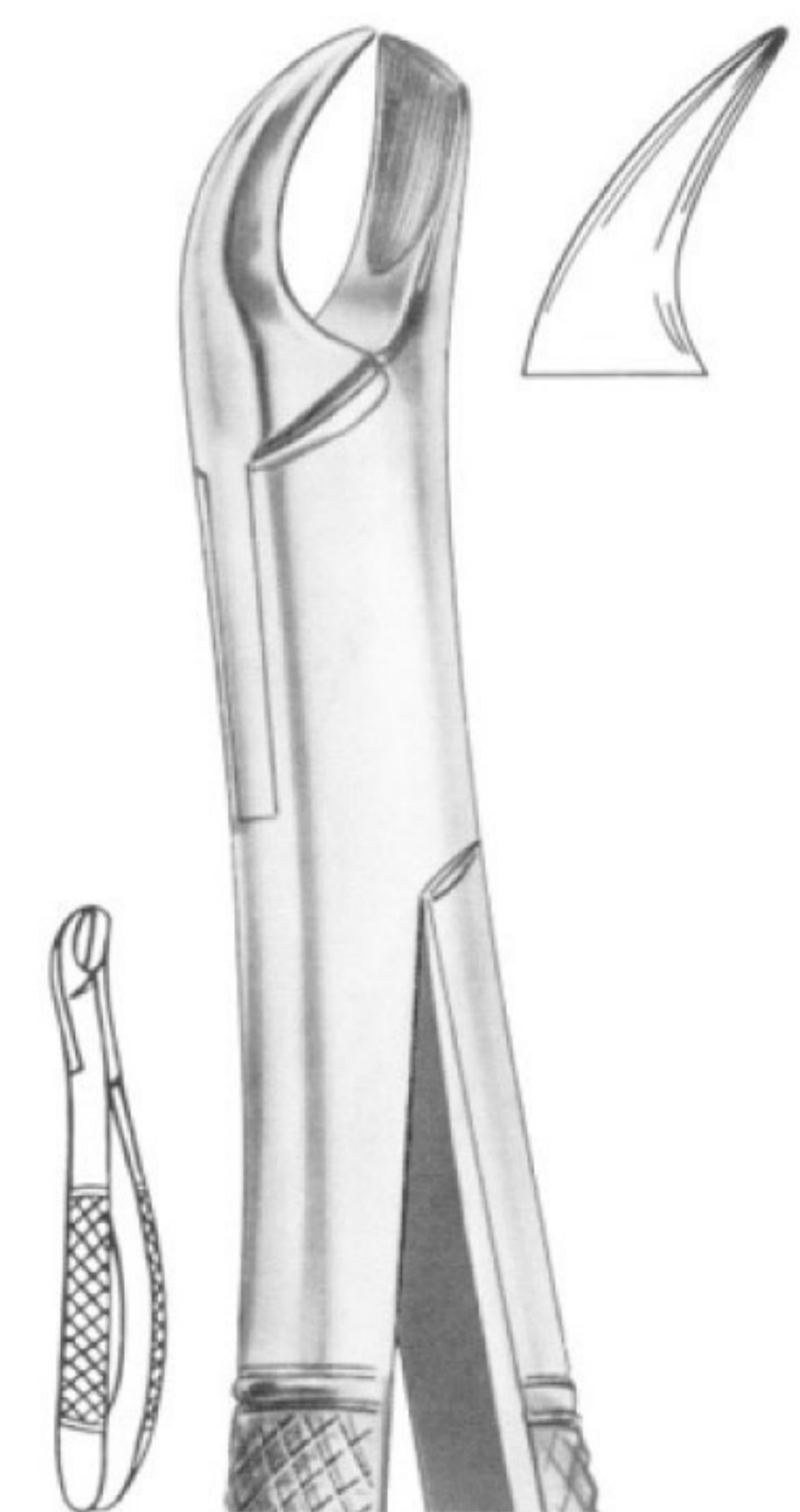
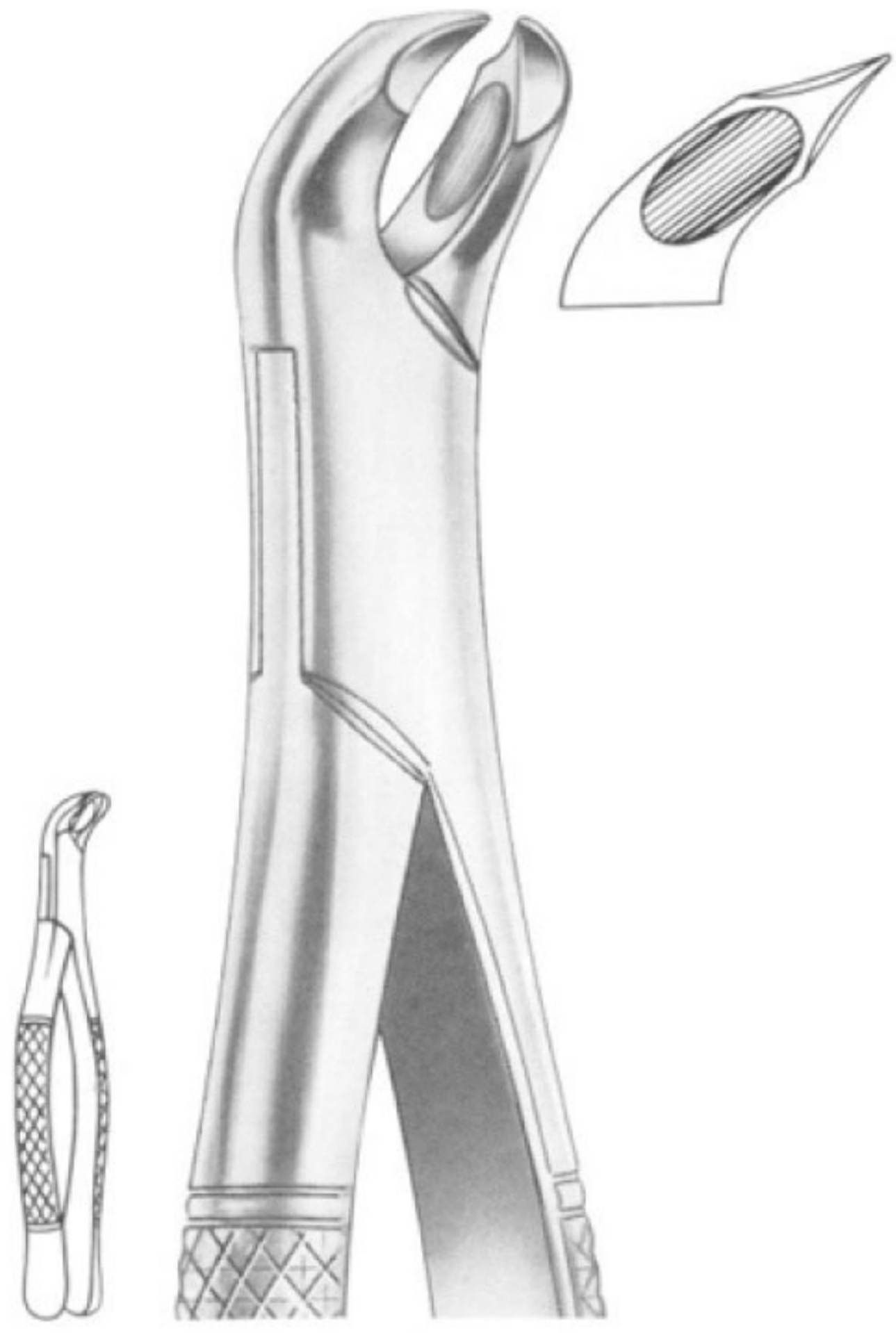

Fig. 340/89 upper molars right
MWD-1290
 Fig. 340/89 upper molars right



WOODWARD Fig. 335/FS lower molars
MWD-1291
 WOODWARD Fig. 335/FS lower molars



Fig. 350/23S lower molars
MWD-1293
 Fig. 350/23S lower molars

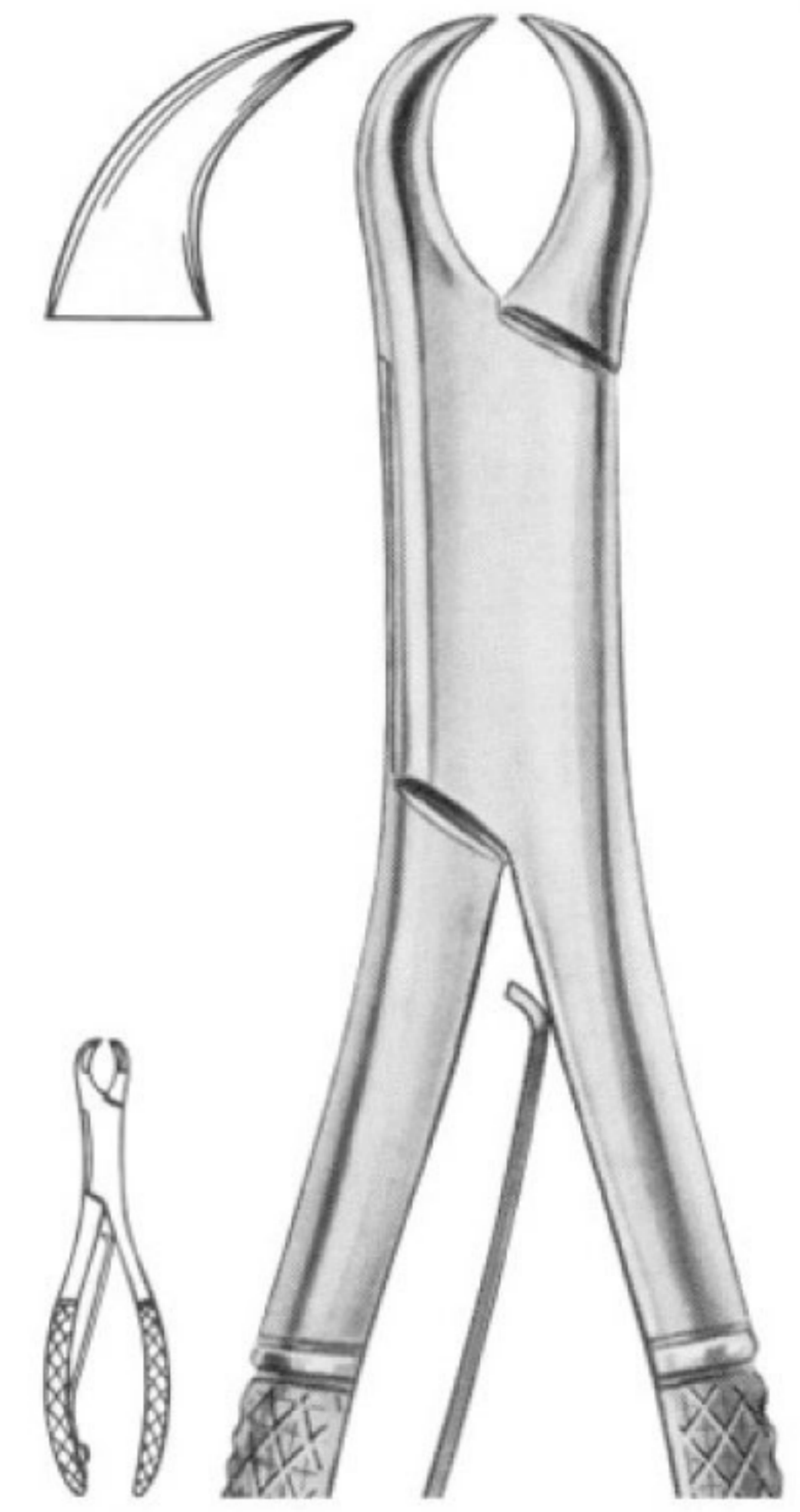

Fig. 355/23SK lower molars
MWD-1294
 Fig. 355/23SK lower molars



Fig. 360/17SK lower molars
MWD-1295
 Fig. 360/17SK lower molars



Fig. 365/150SK upper anteriors and roots
MWD-1296
 Fig. 365/150SK upper anteriors and roots



Fig. 370/151SK lower anteriors and roots
MWD-1297
 Fig. 370/151SK lower anteriors and roots



Fig. 1 upper laterals and canines
MWD-1145

Fig. 1 upper laterals and canines

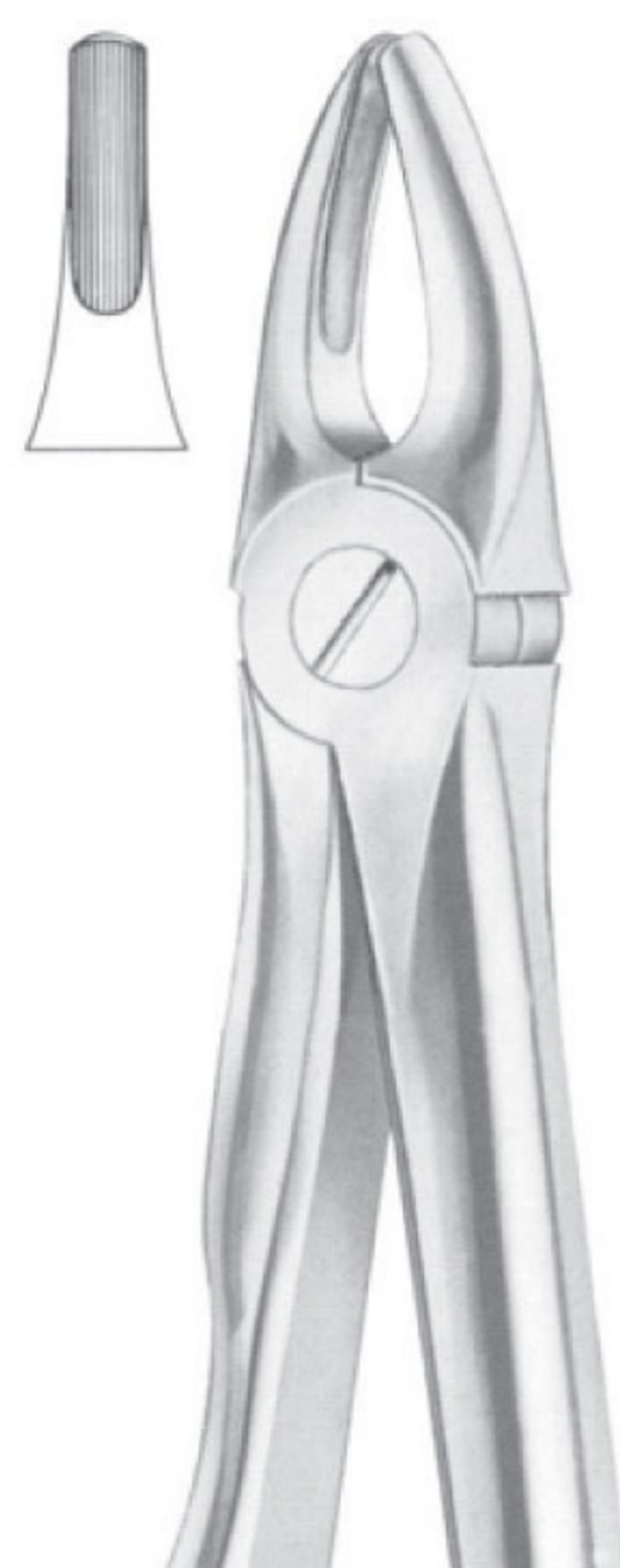

Fig. 2 upper laterals and canines
MWD-1146

Fig. 2 upper laterals and canines

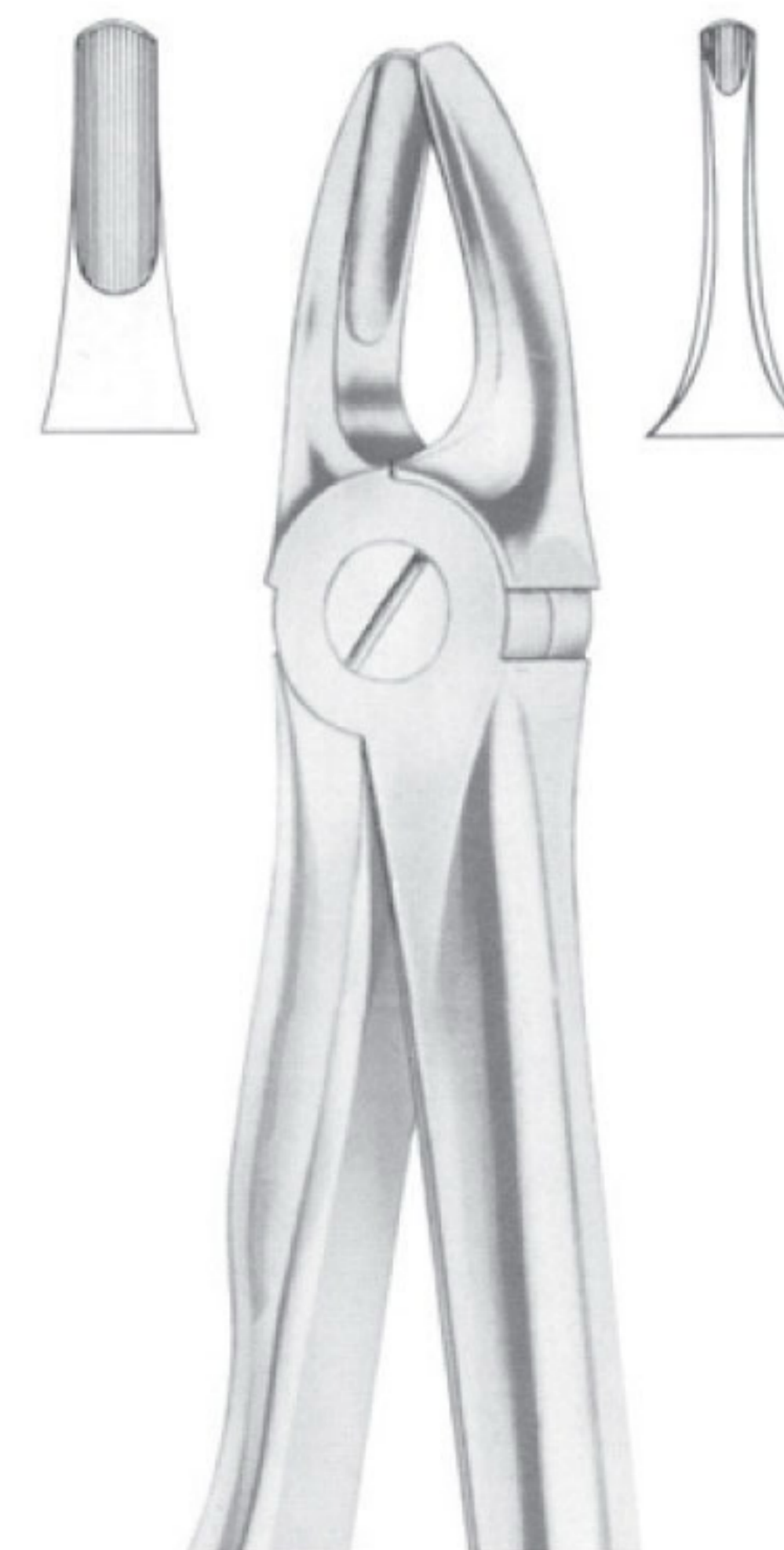

Fig. 3 upper incisors and canines
MWD-1147

Fig. 3 upper incisors and canines

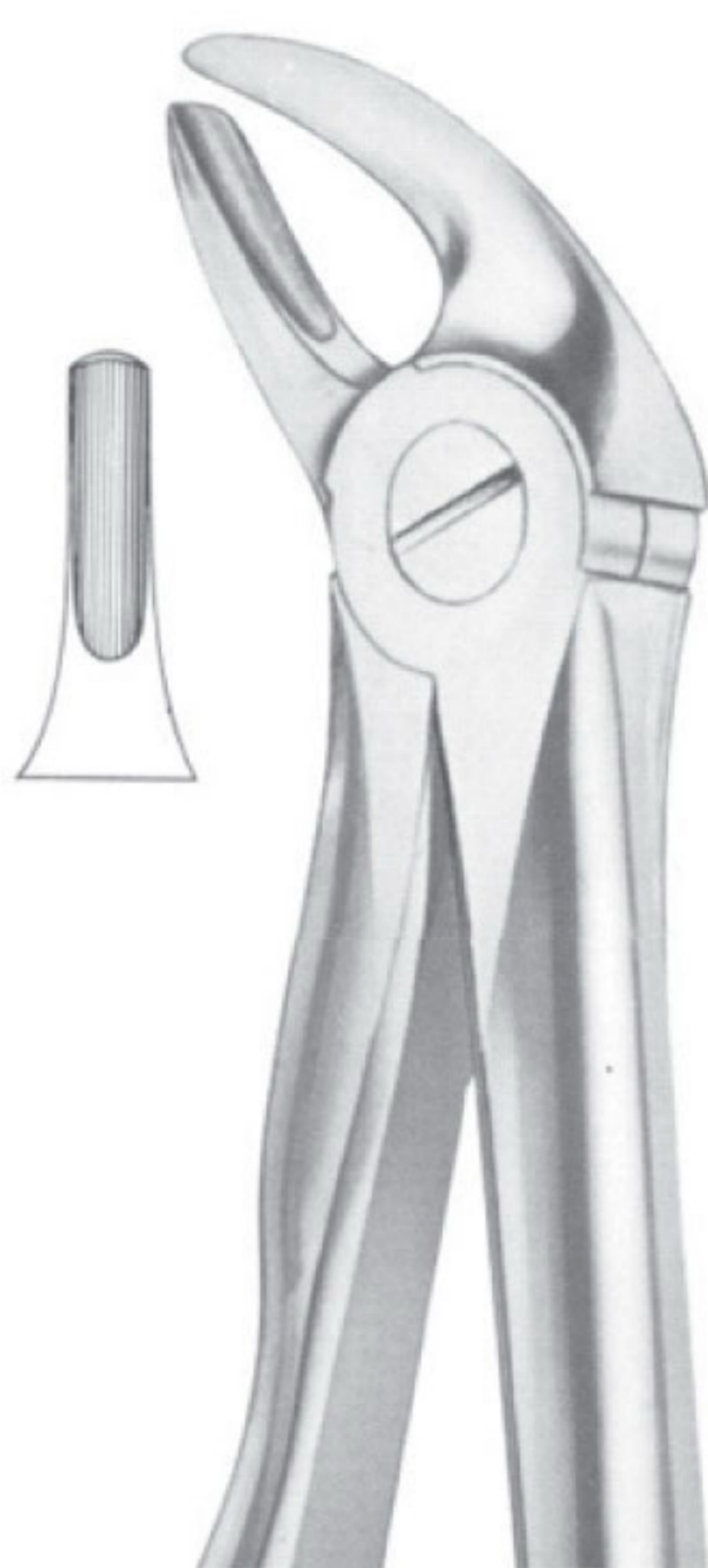

Fig. 4 lower incisors and canines
MWD-1148

Fig. 4 lower incisors and canines

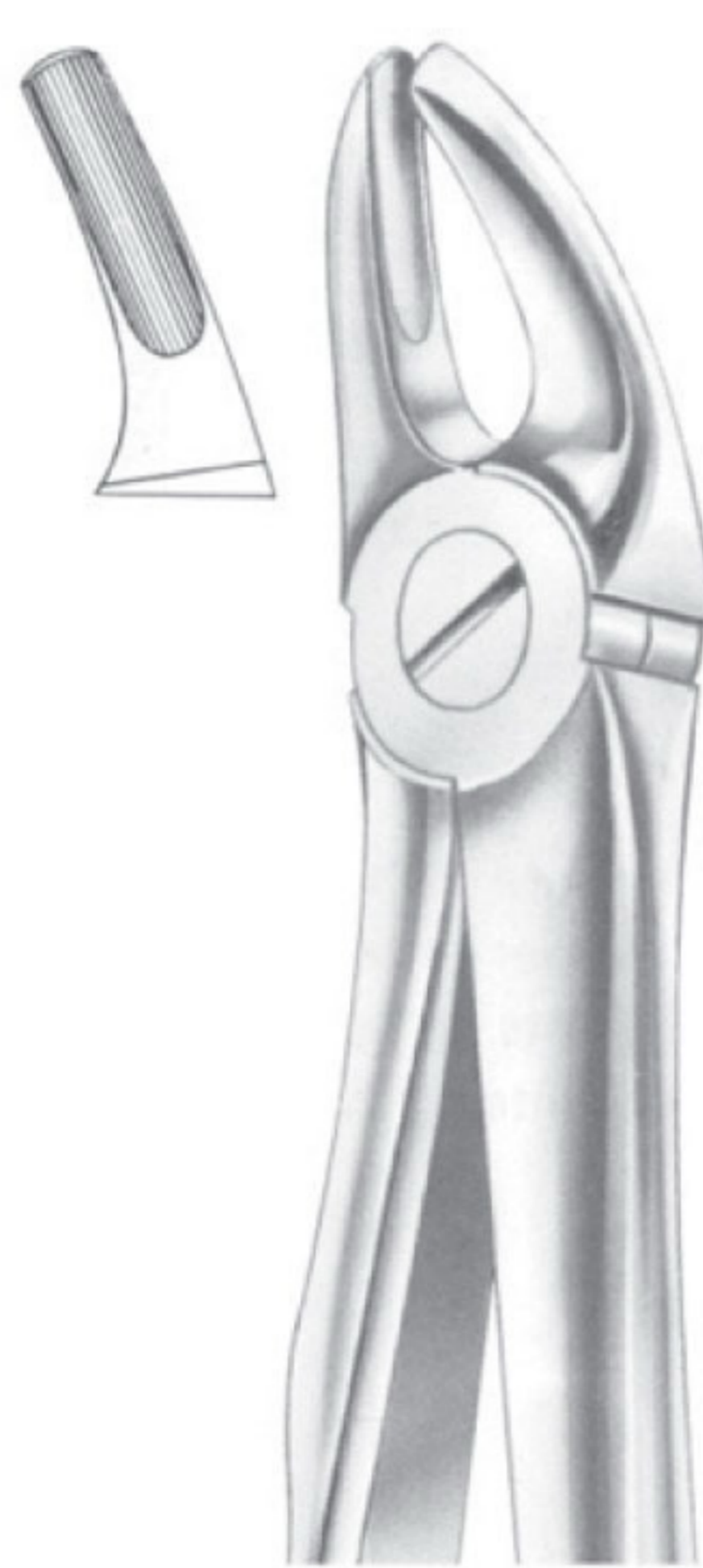

Fig. 7 upper premolars
MWD-1149

Fig. 7 upper premolars

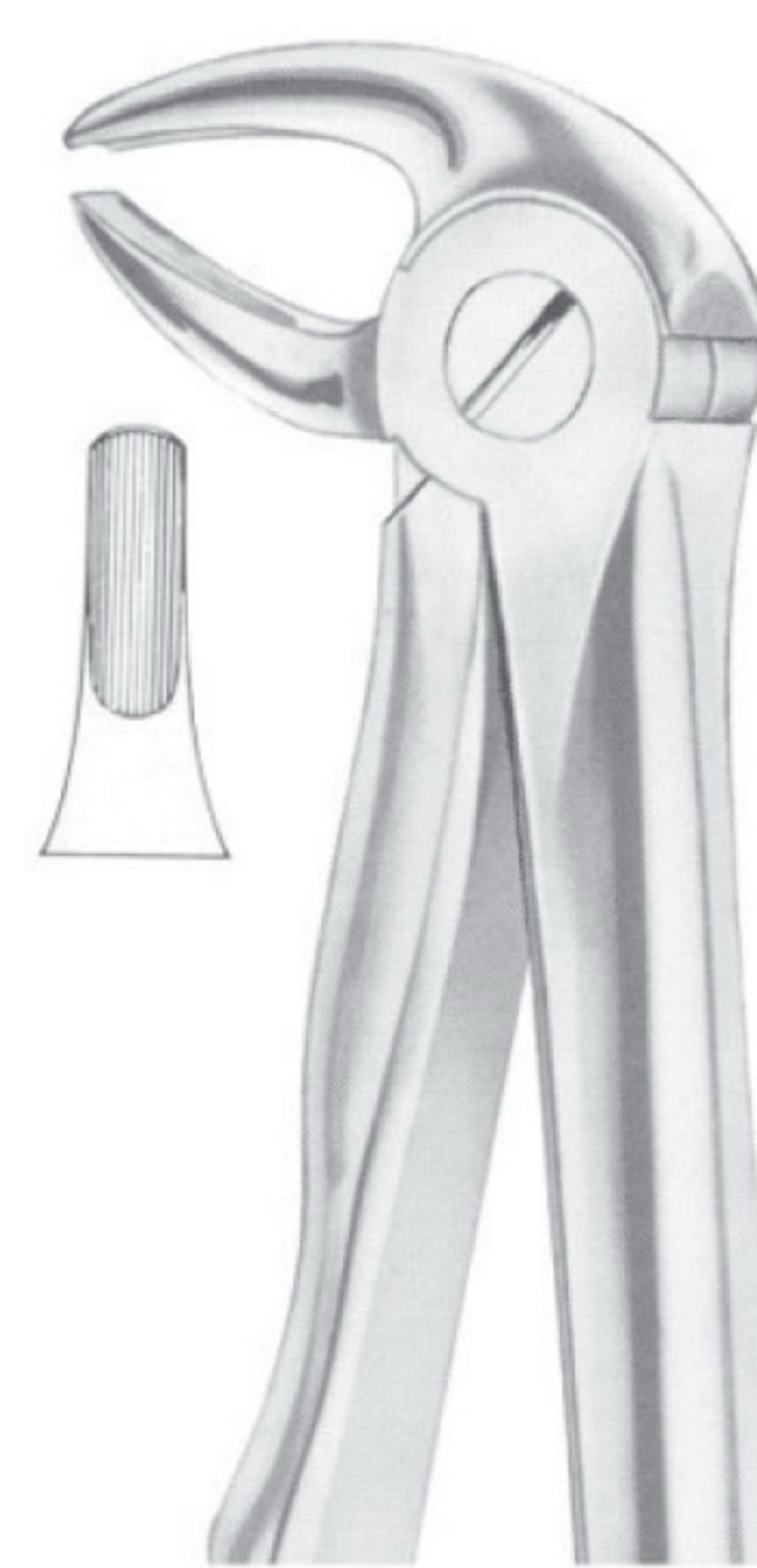

Fig. 13 lower premolars
MWD-1150

Fig. 13 lower premolars

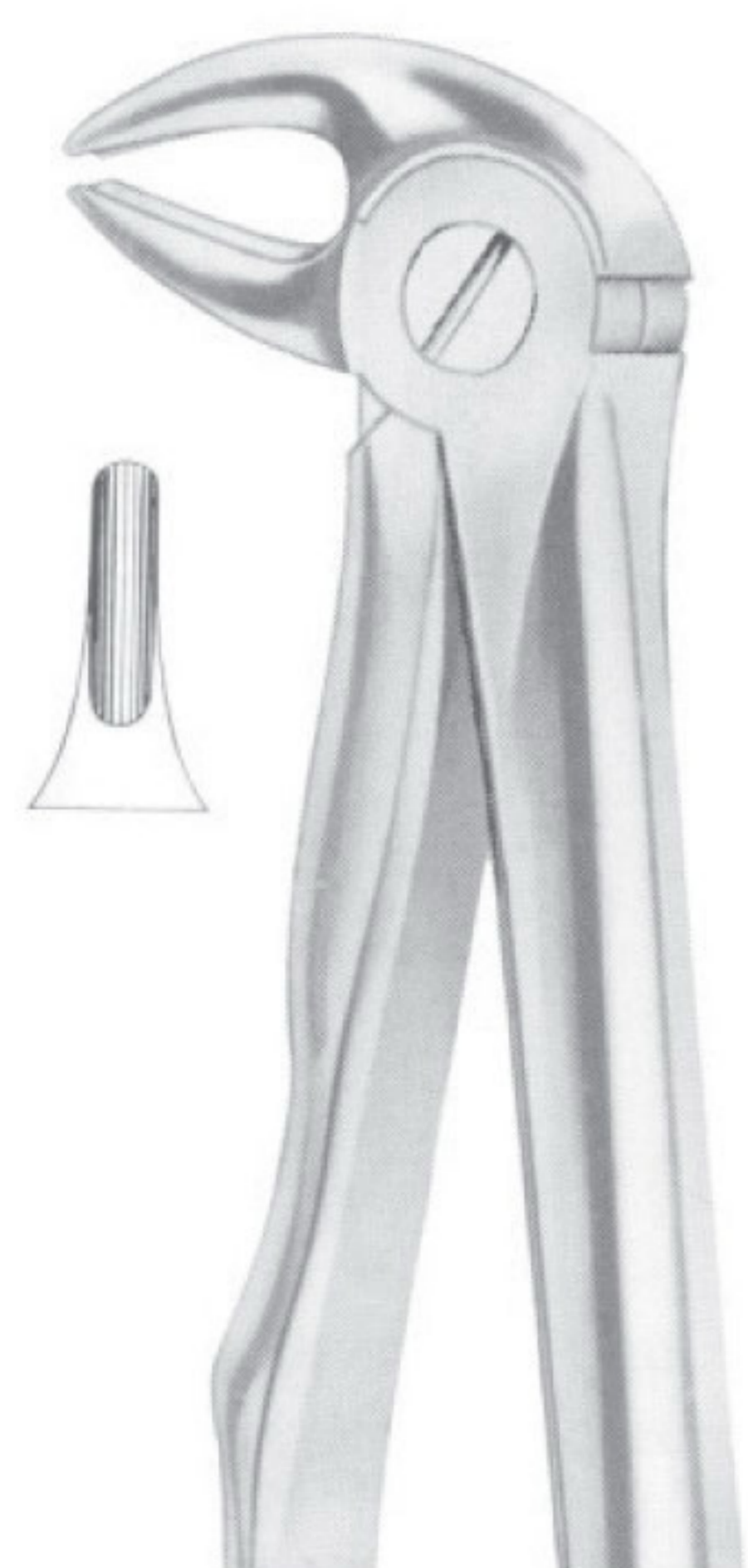

Fig. 13S lower premolars for children
MWD-1151

Fig. 13S lower premolars for children



Fig. 17 upper molars right
MWD-1152

Fig. 17 upper molars right

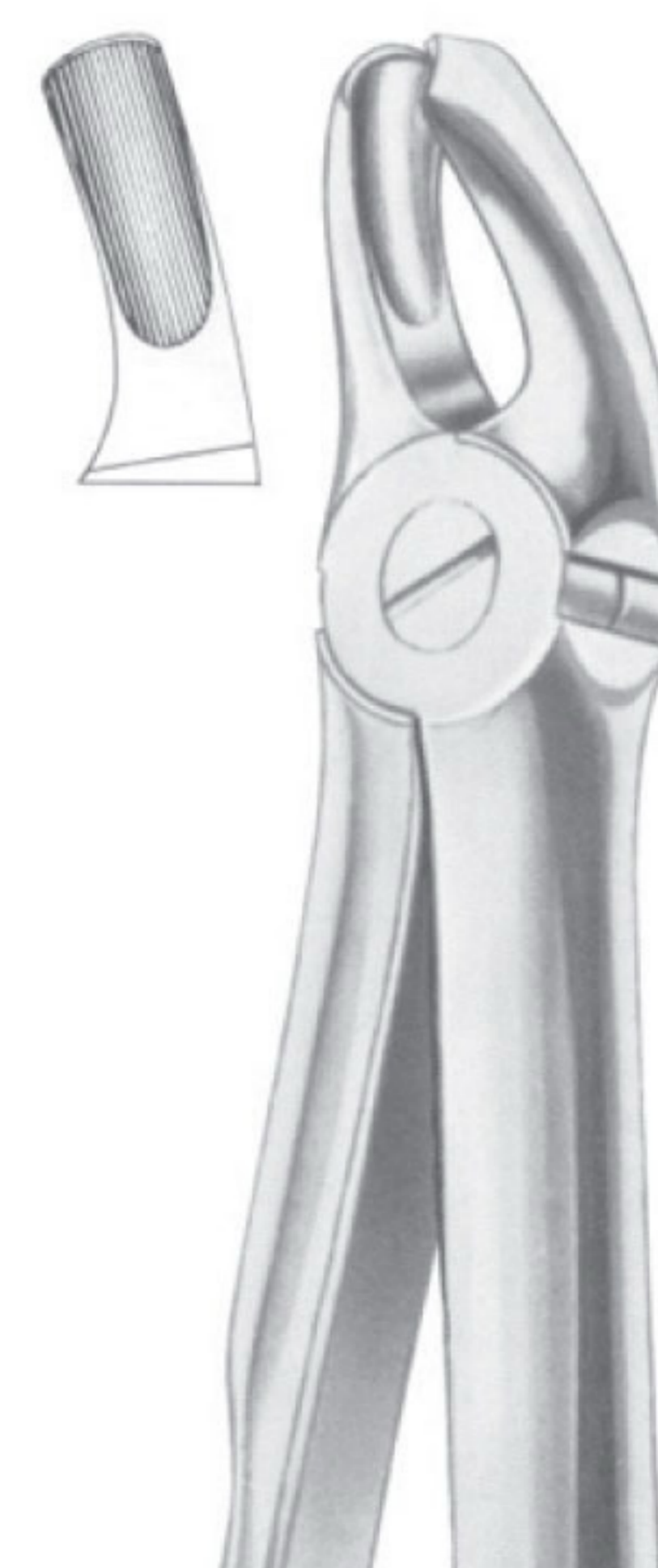

Fig. 18 upper molars left
MWD-1153

Fig. 18 upper molars left

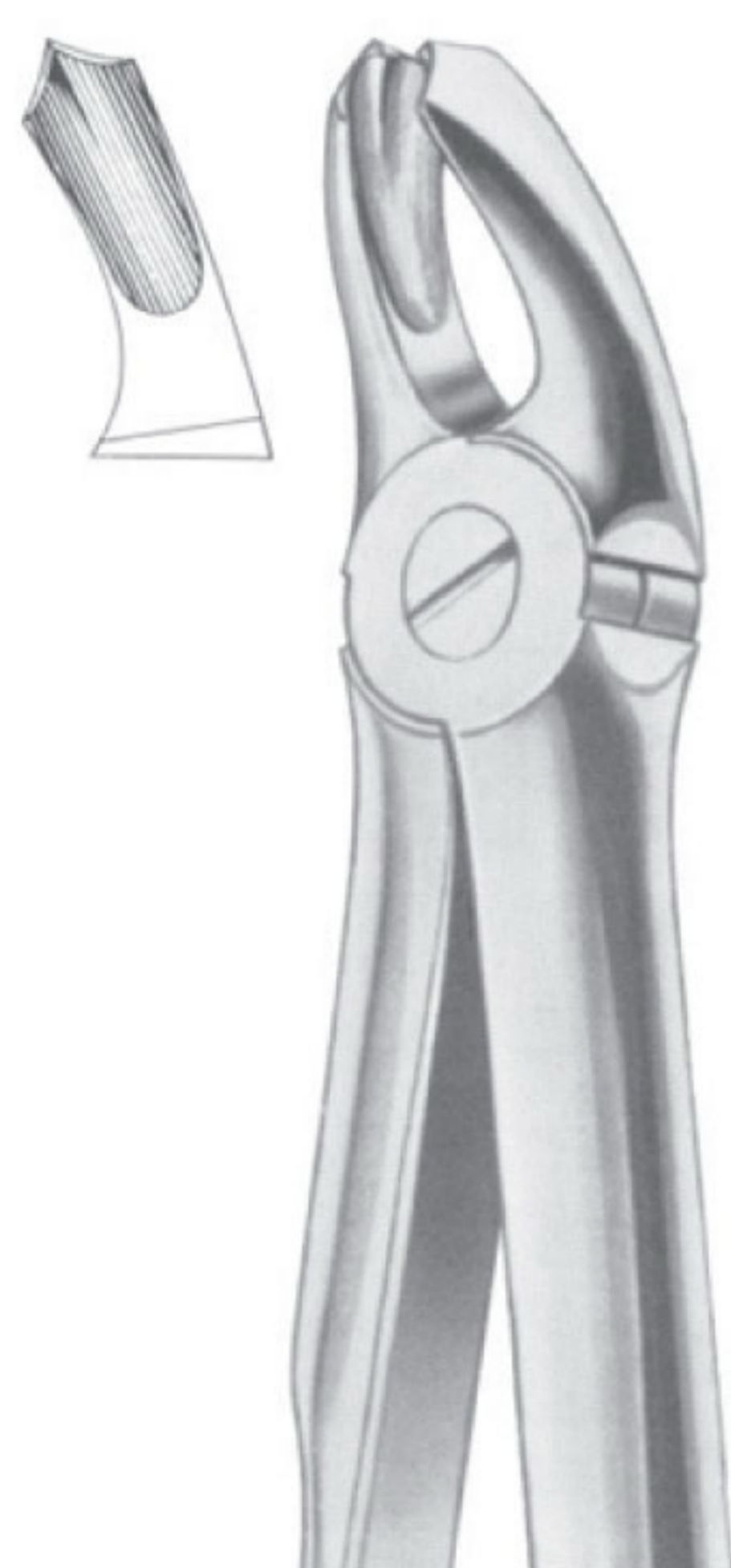

Fig. 18A upper molars
MWD-1154

Fig. 18A upper molars

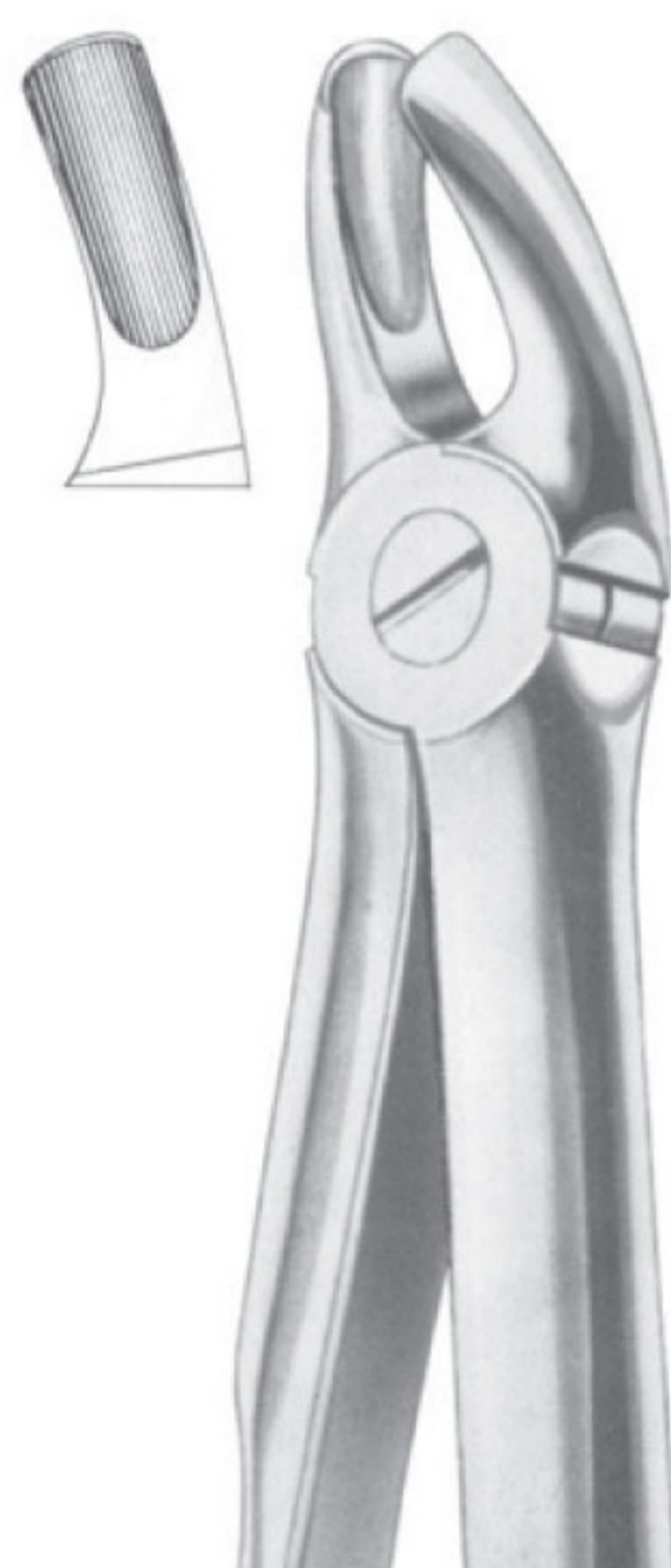

Fig. 18B upper molars
MWD-1155

Fig. 18B upper molars



Fig. 19 upper third molars
MWD-1156

Fig. 19 upper third molars

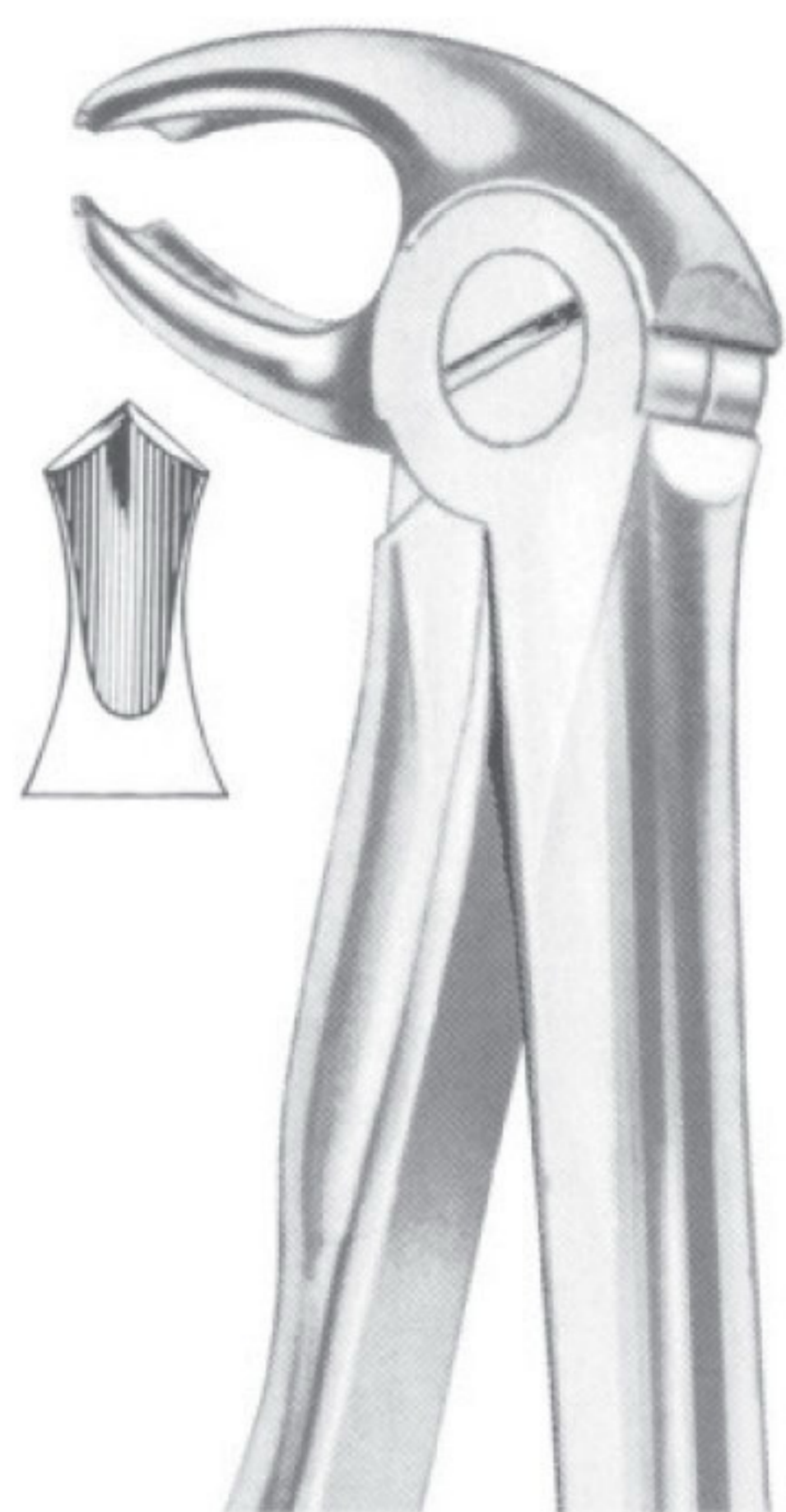

Fig. 22 lower molars
MWD-1157
Fig. 22 lower molars

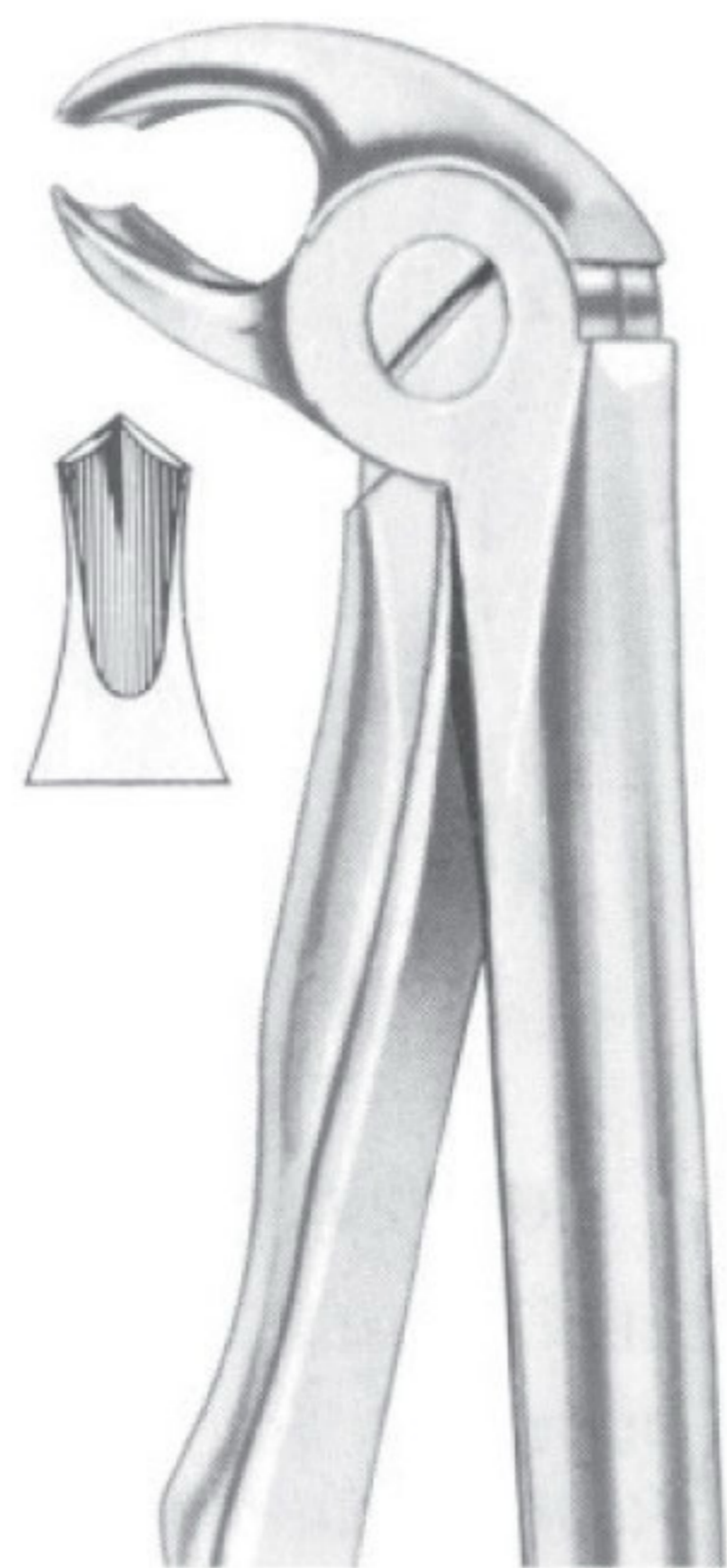

Fig. 22S lower molars for children
MWD-1158
Fig. 22S lower molars for children



Fig. 29 upper roots
MWD-1159
Fig. 29 upper roots

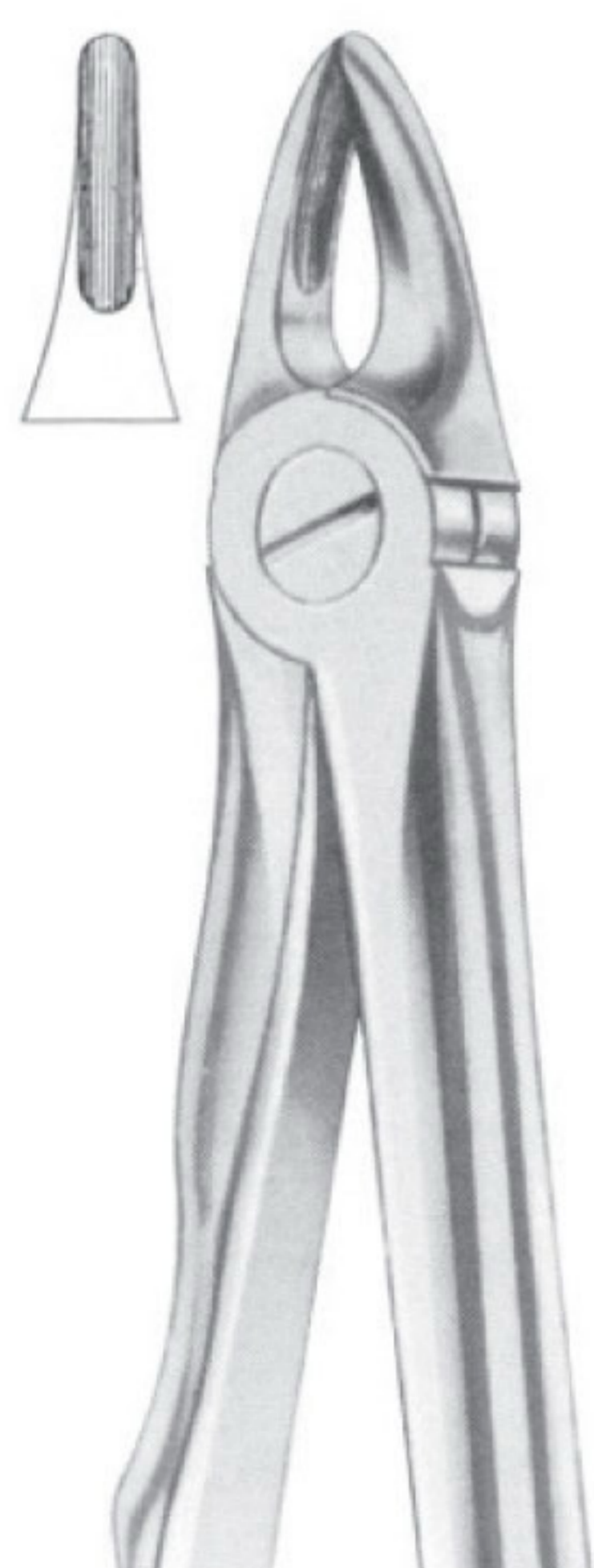

Fig. 29S upper roots for children
MWD-1160
Fig. 29S upper roots for children

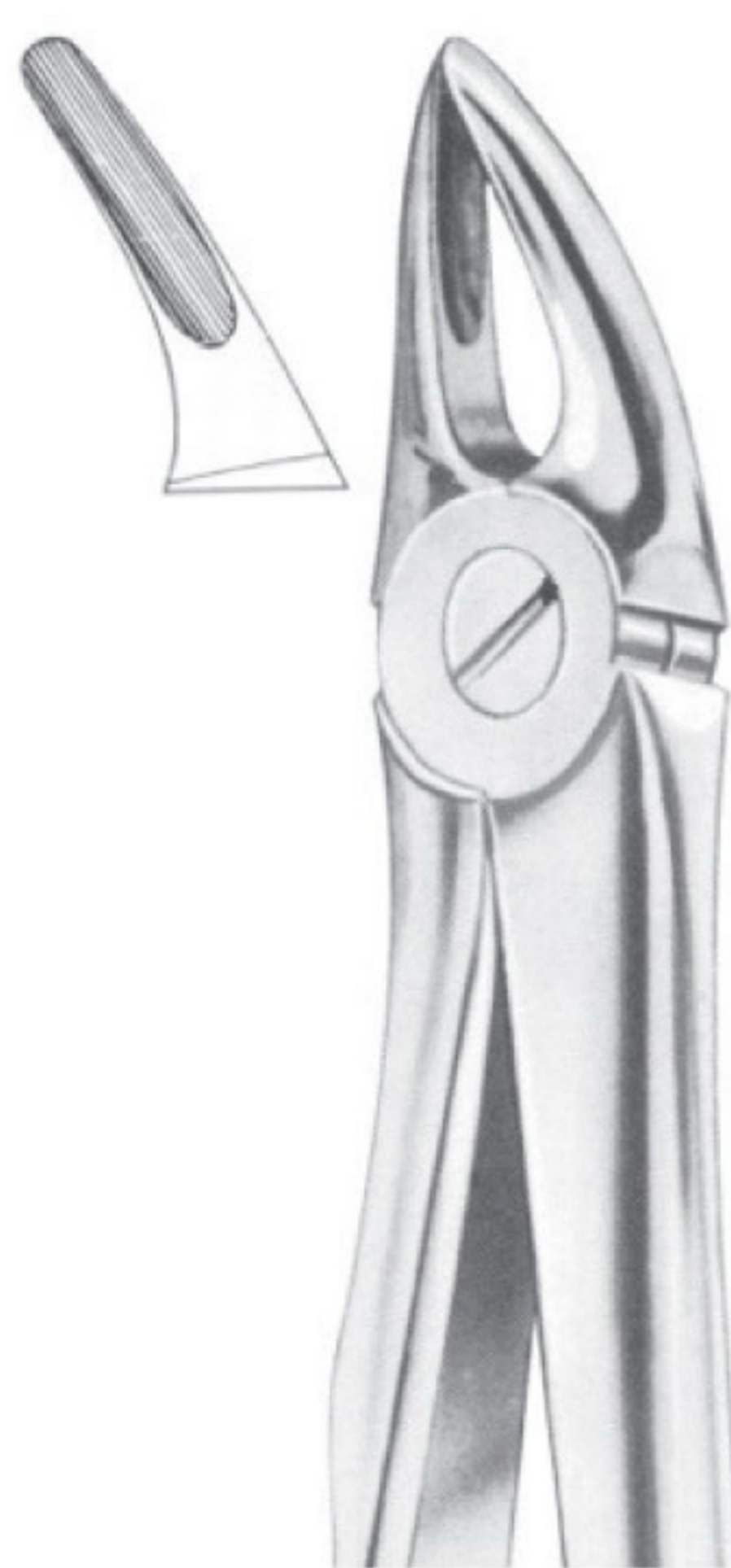

Fig. 30 upper roots
MWD-1161
Fig. 30 upper roots

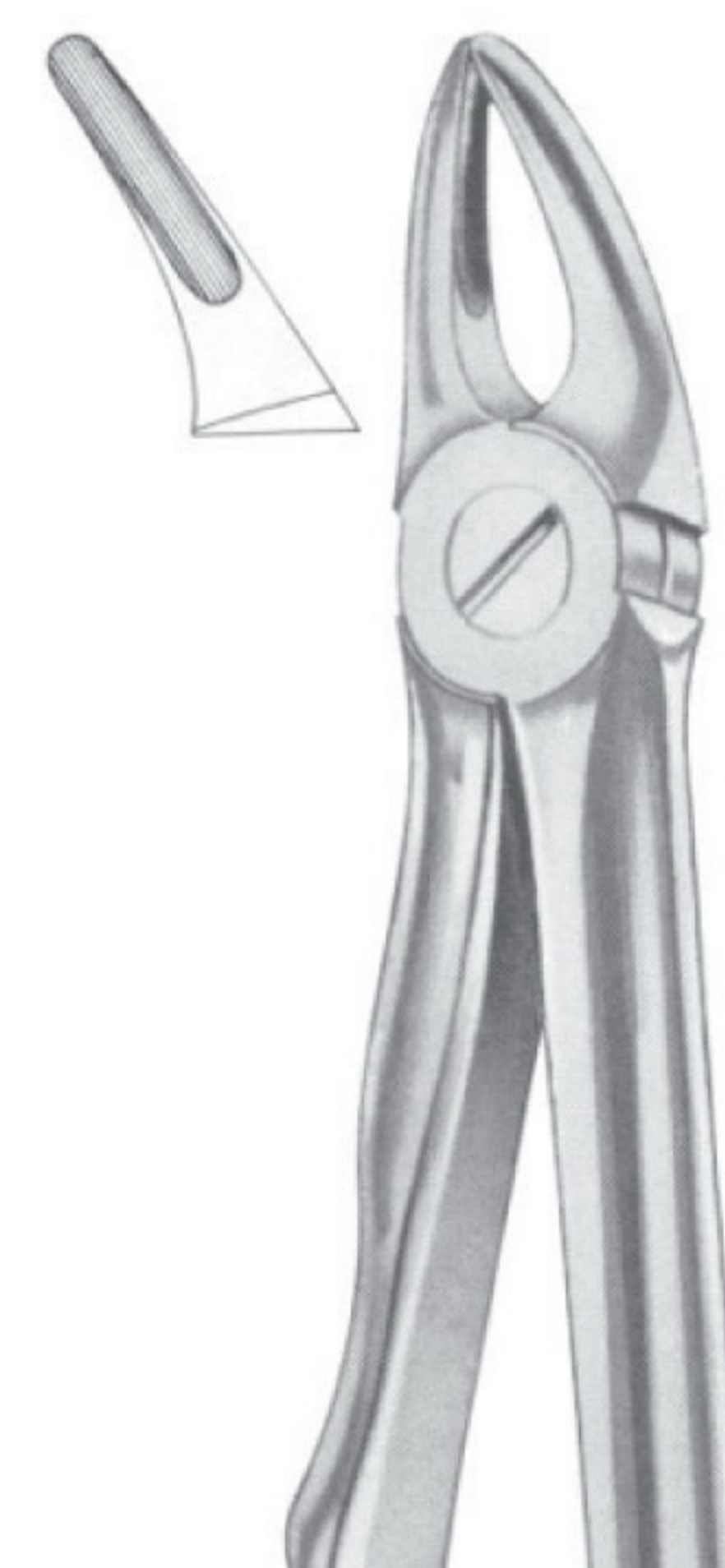

Fig. 30S upper roots for children
MWD-1162
Fig. 30S upper roots for children

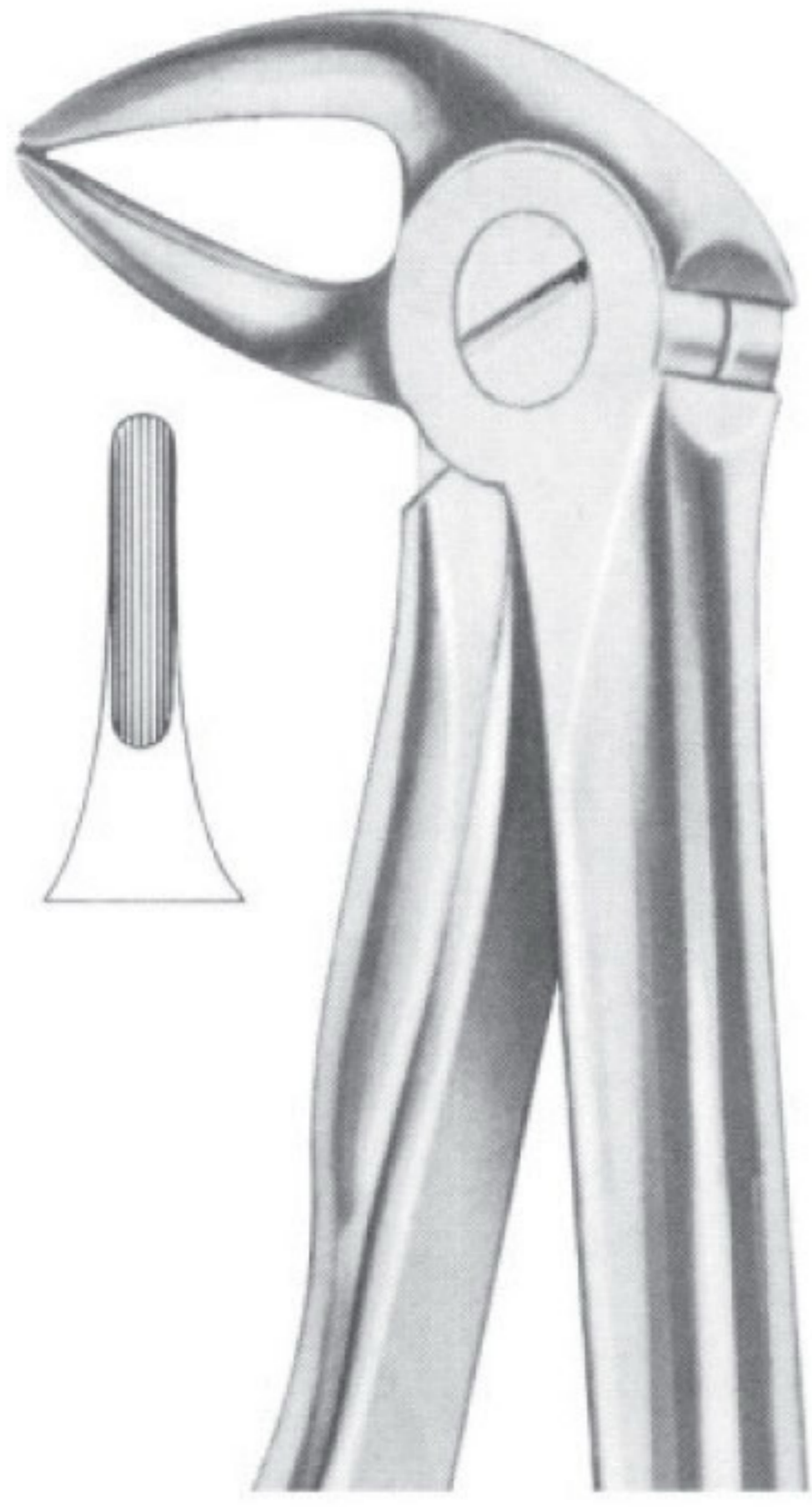

Fig. 33 lower roots
MWD-1163
Fig. 33 lower roots

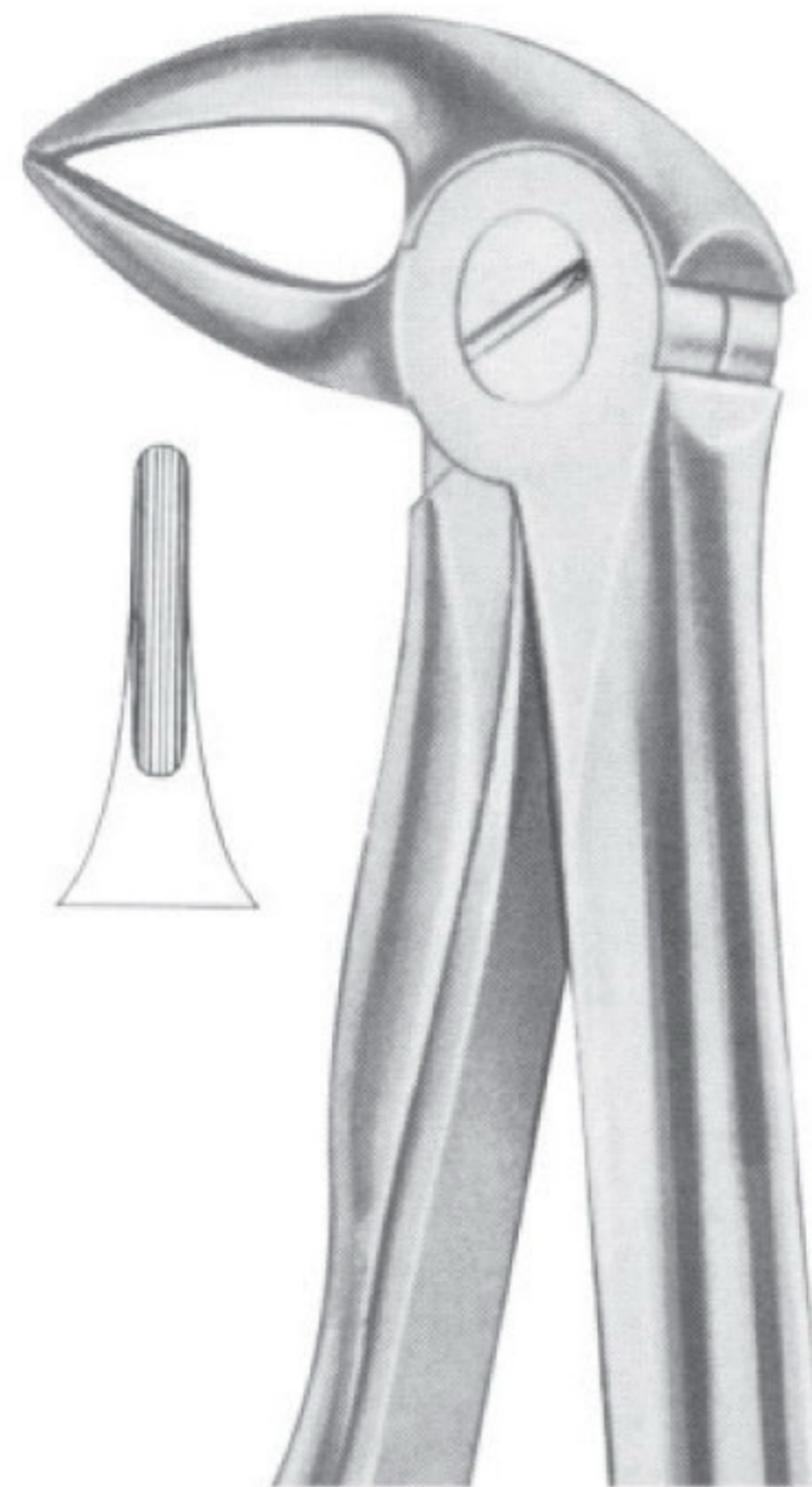

Fig. 33A lower roots
MWD-1164
Fig. 33A lower roots

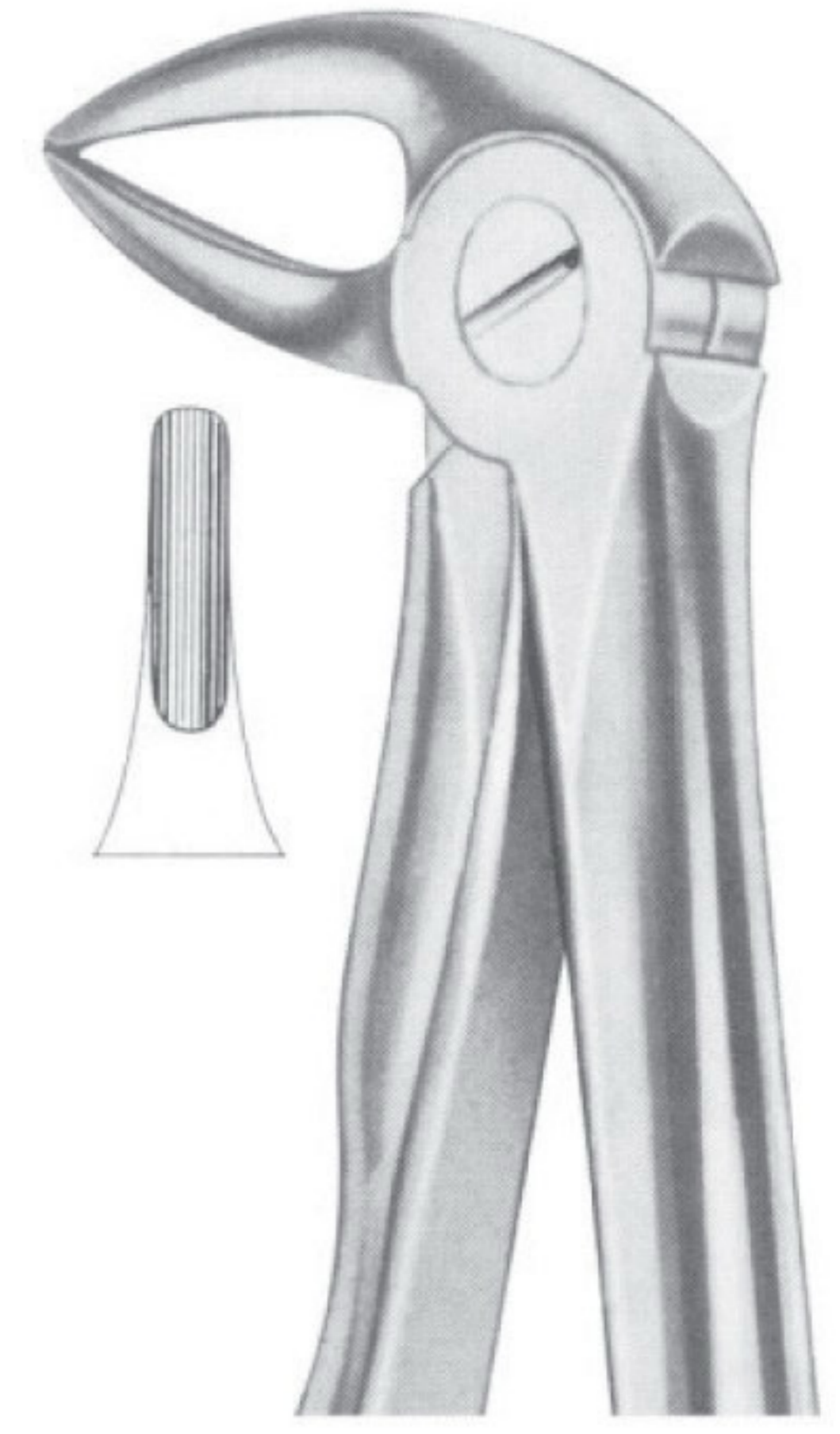

Fig. 33B lower roots
MWD-1165
Fig. 33B lower roots



Fig. 33L lower roots
MWD-1166
Fig. 33L lower roots

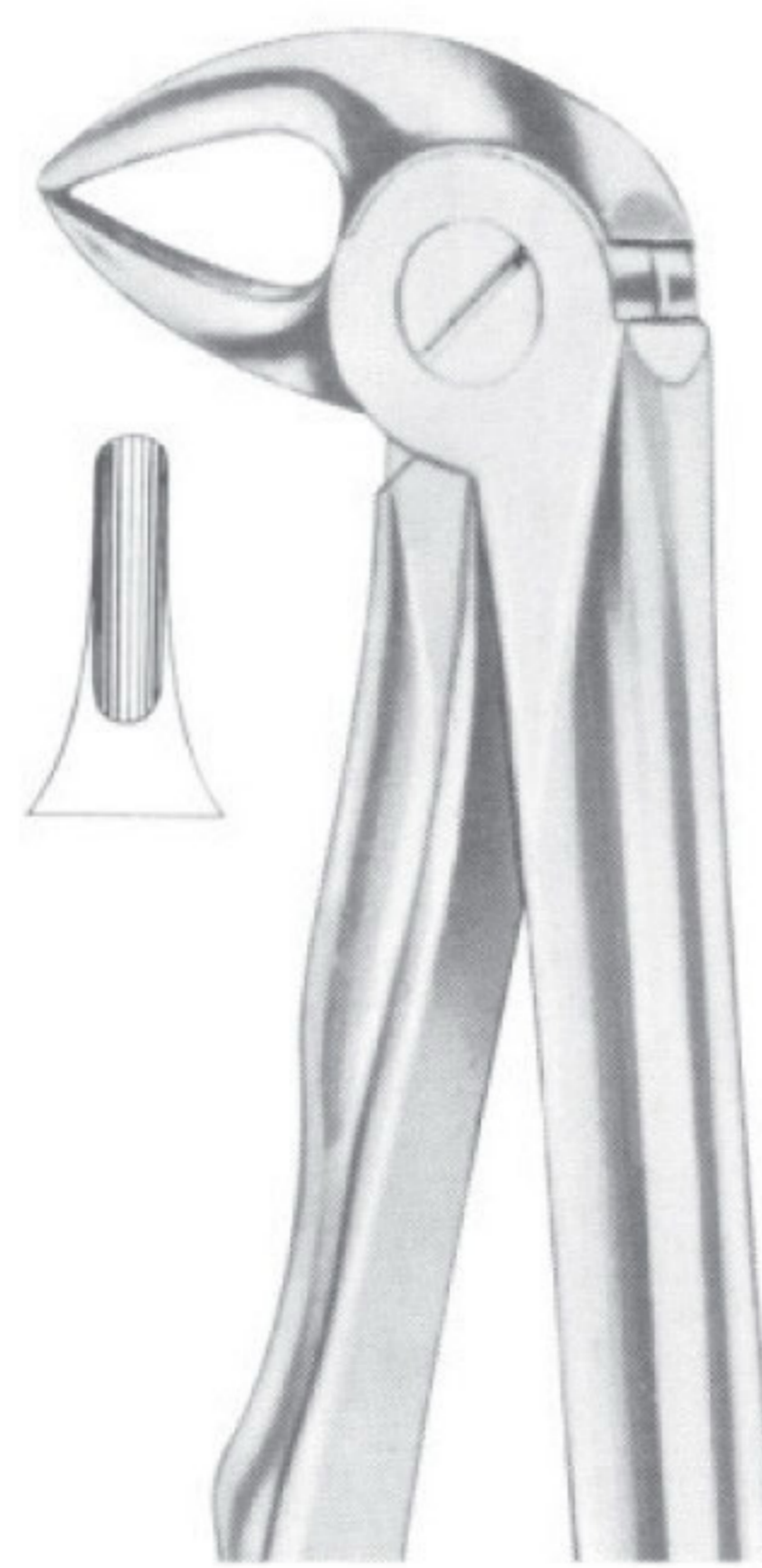

Fig. 33S lower roots for children
MWD-1167
Fig. 33S lower roots for children

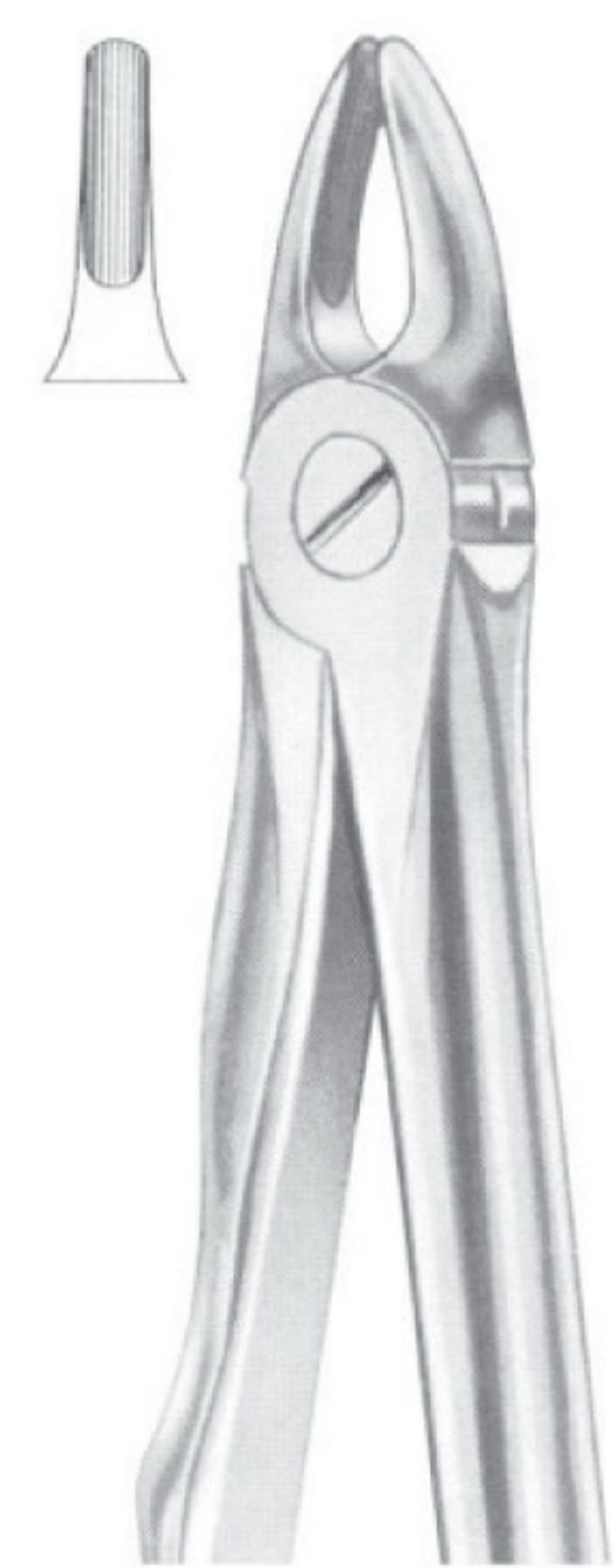

Fig. 37 upper incisors for children
MWD-1168
Fig. 37 upper incisors for children



Fig. 39 upper incisors for children
MWD-1169
 Fig. 39 upper incisors for children



Fig. 39A upper molars for children
MWD-1170
 Fig. 39A upper molars for children

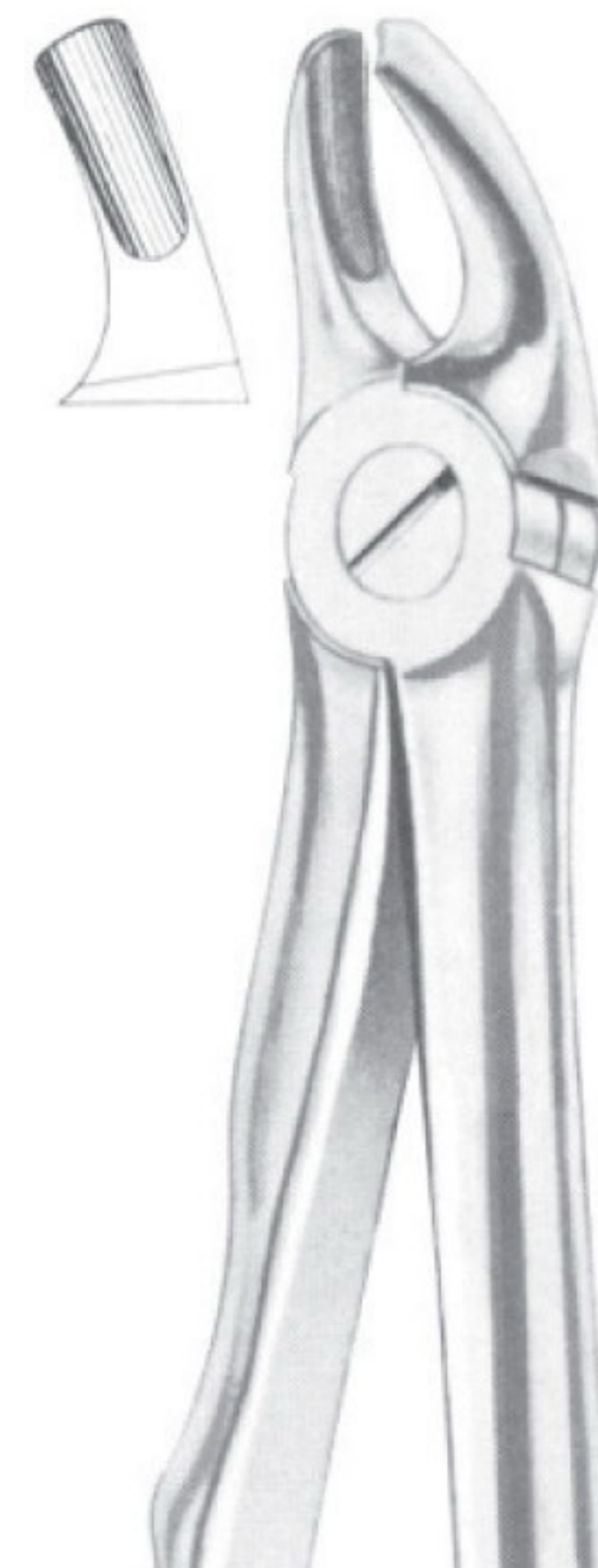

Fig. 39L upper molars left for children
MWD-1172
 Fig. 39L upper molars left for children



Fig. 41 upper roots
MWD-1173
 Fig. 41 upper roots

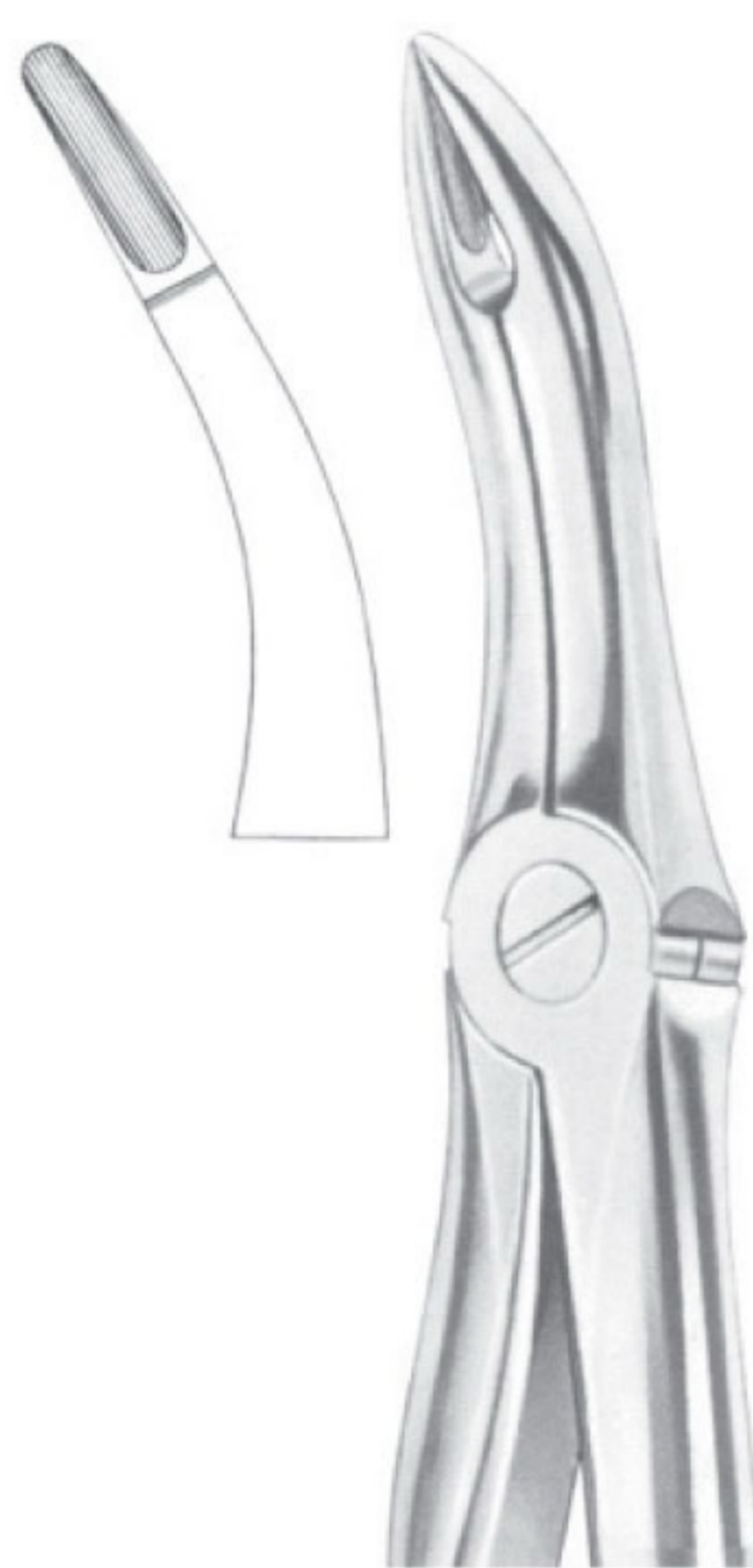

Fig. 44 upper roots
MWD-1174
 Fig. 44 upper roots

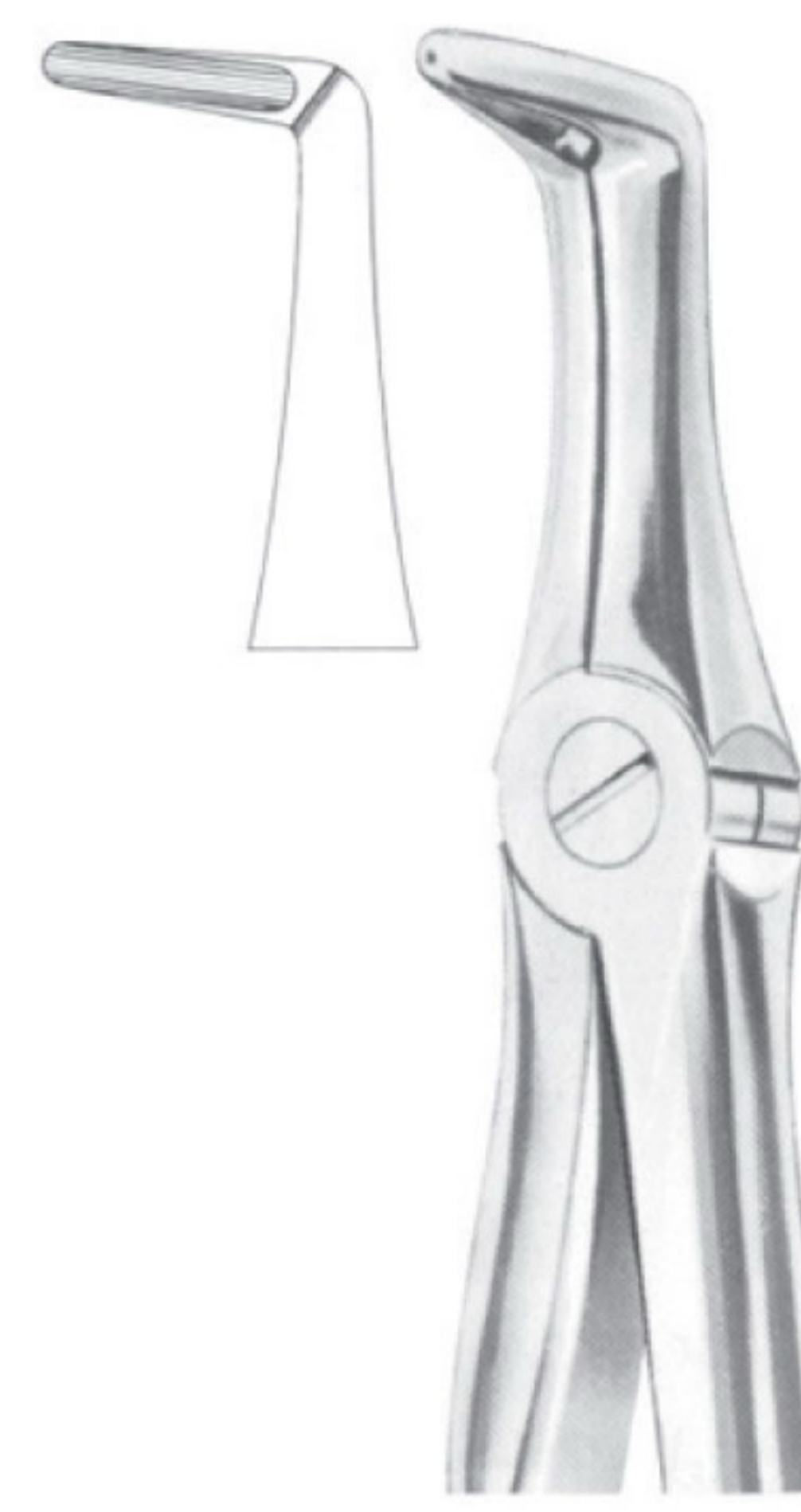

Fig. 45 lower roots
MWD-1175
 Fig. 45 lower roots

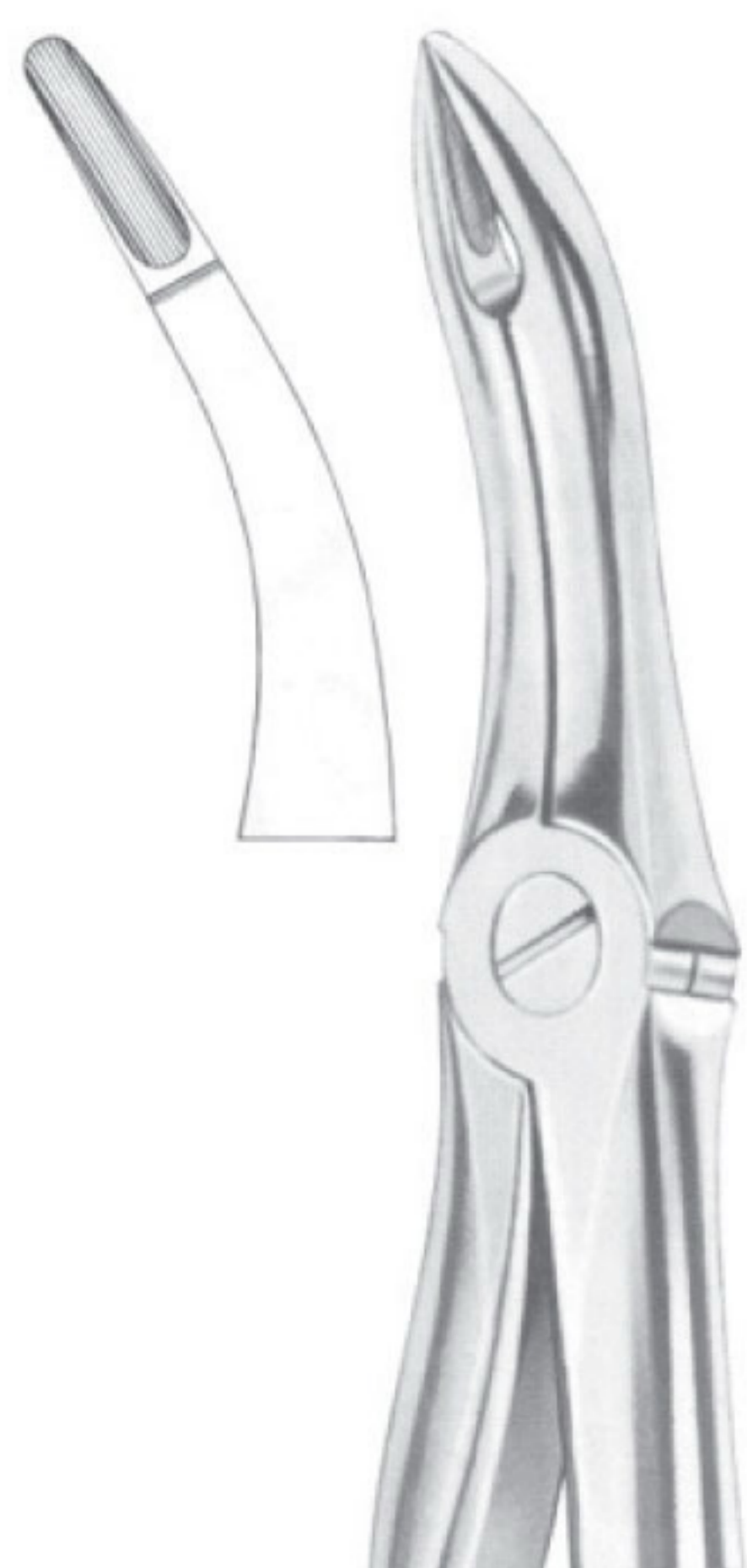

Fig. 48 lower roots
MWD-1176
Fig. 48 lower roots

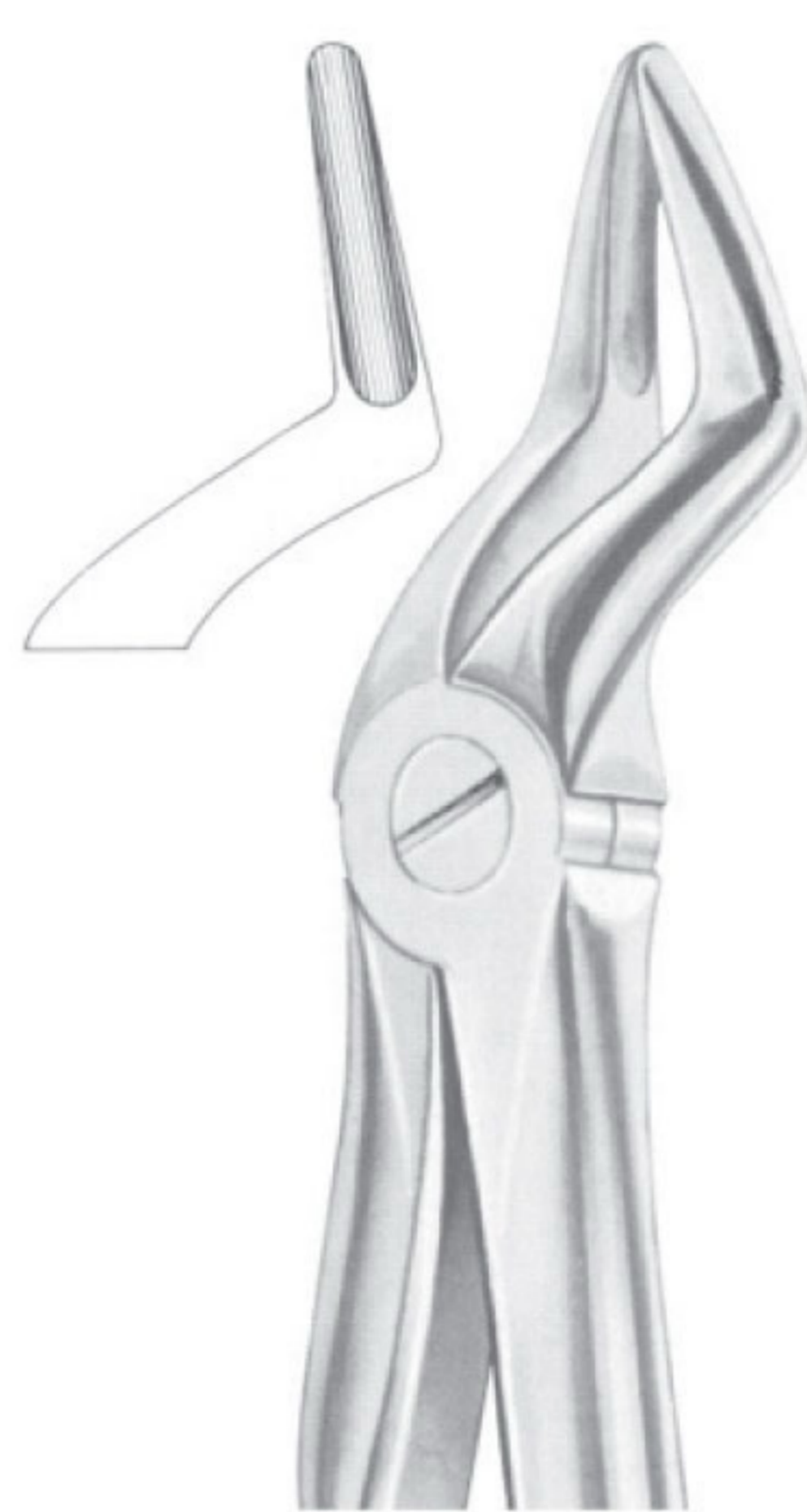

Fig. 51 upper roots
MWD-1177
Fig. 51 upper roots



Fig. 51A upper roots
MWD-1178
Fig. 51A upper roots



Fig. 51L upper roots
MWD-1180
Fig. 51L upper roots

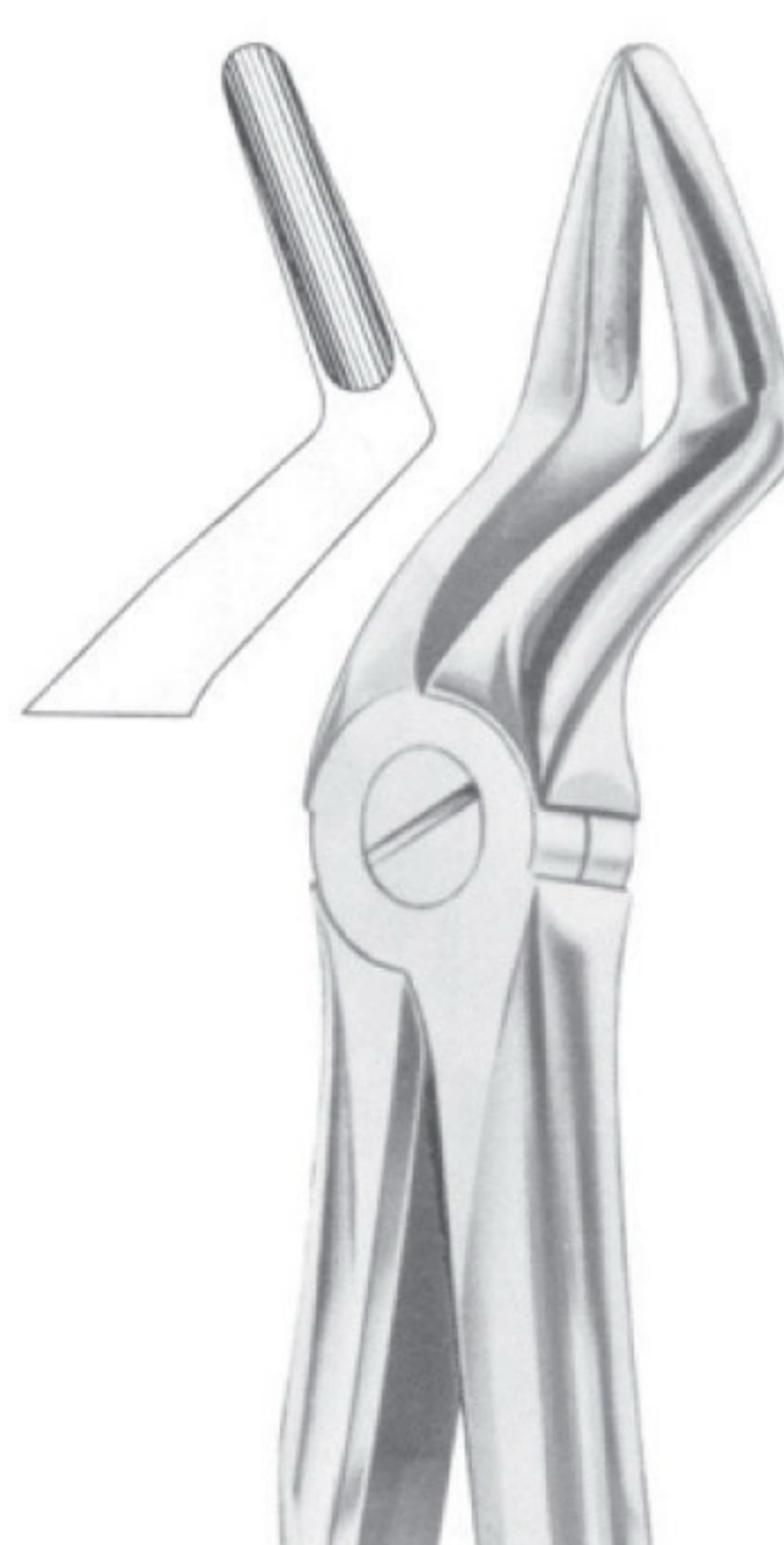

Fig. 52 upper roots
MWD-1181
Fig. 52 upper roots

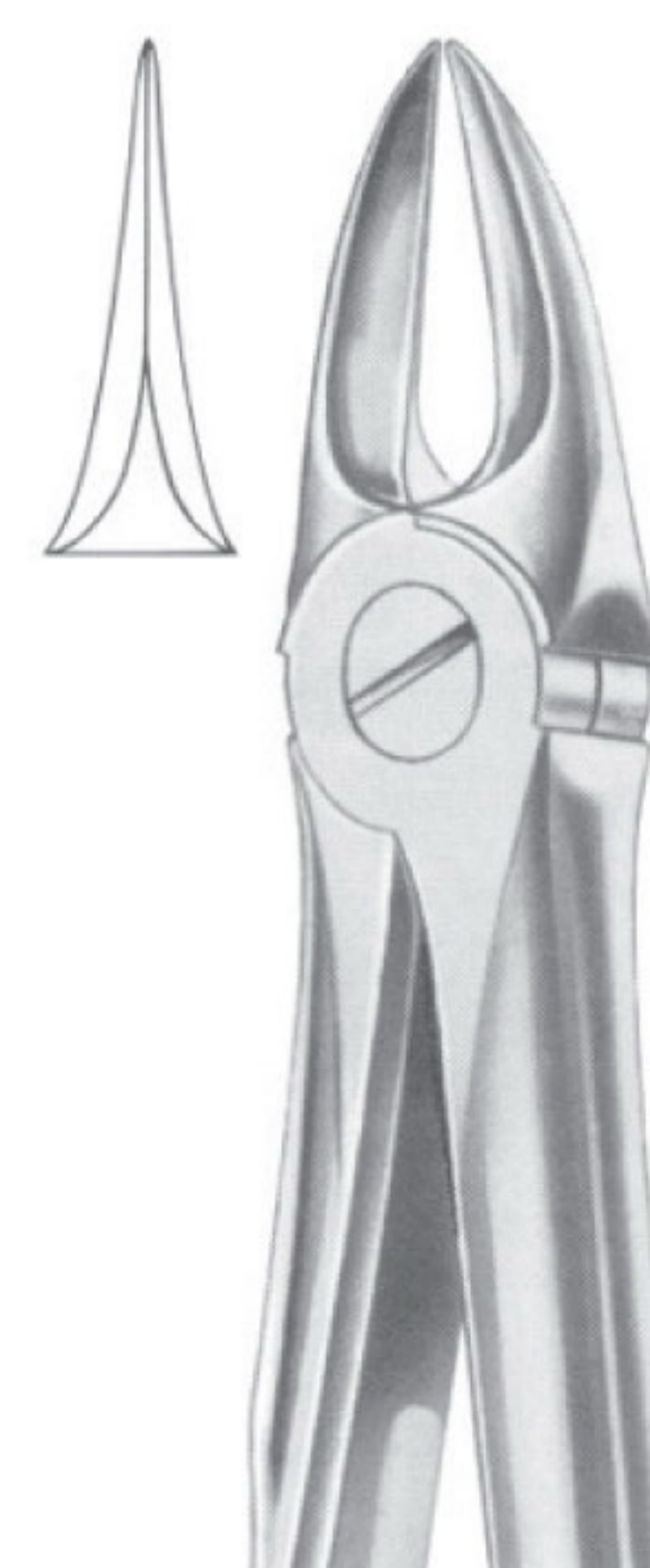

Fig. 54 for separating upper molars
MWD-1182
Fig. 54 for separating upper molars

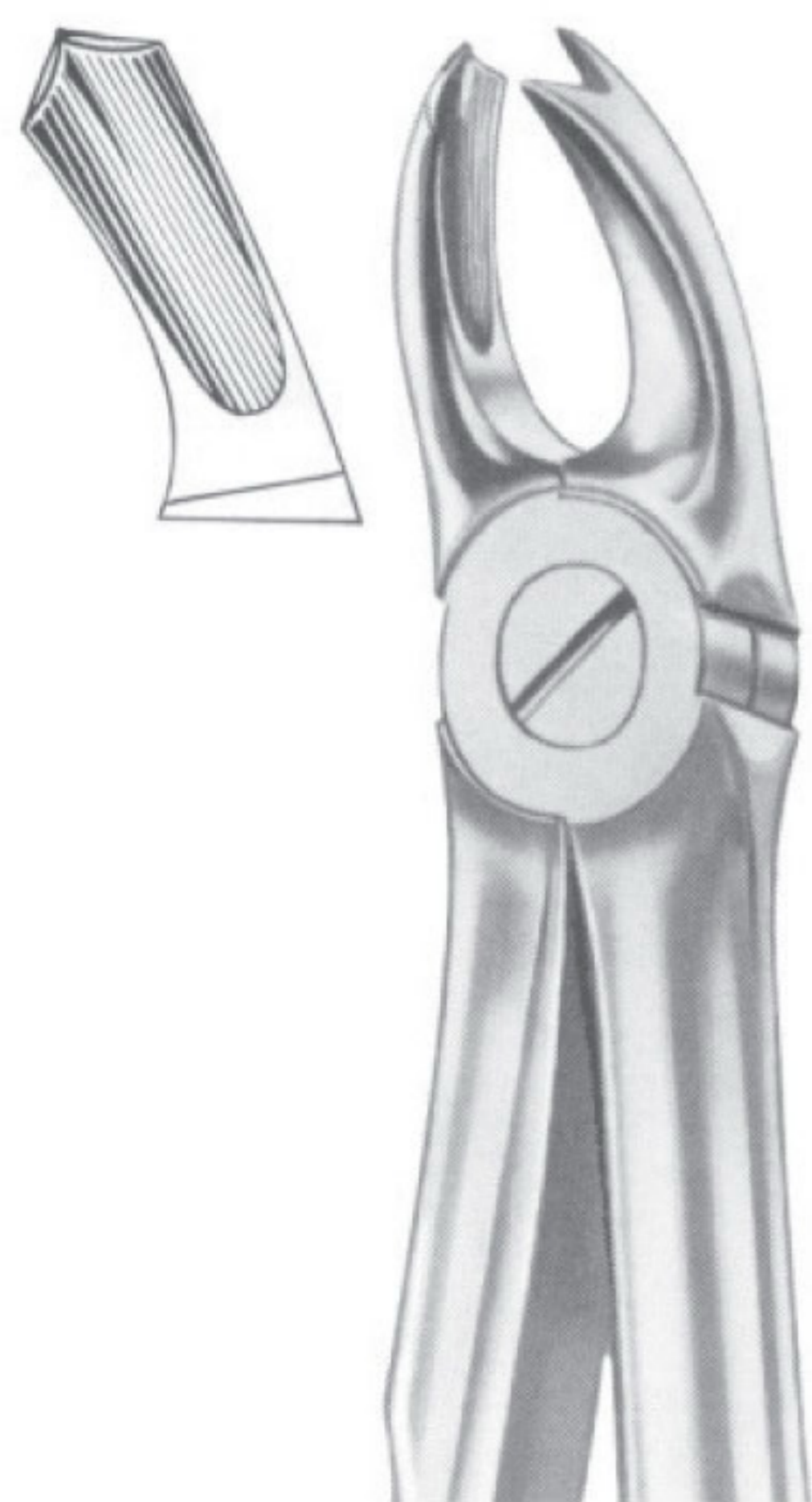

Fig. 65R upper molars right
MWD-1183
Fig. 65R upper molars right



Fig. 65L upper molars left
MWD-1184
Fig. 65L upper molars left



Fig. 67 upper third molars
MWD-1185
Fig. 67 upper third molars

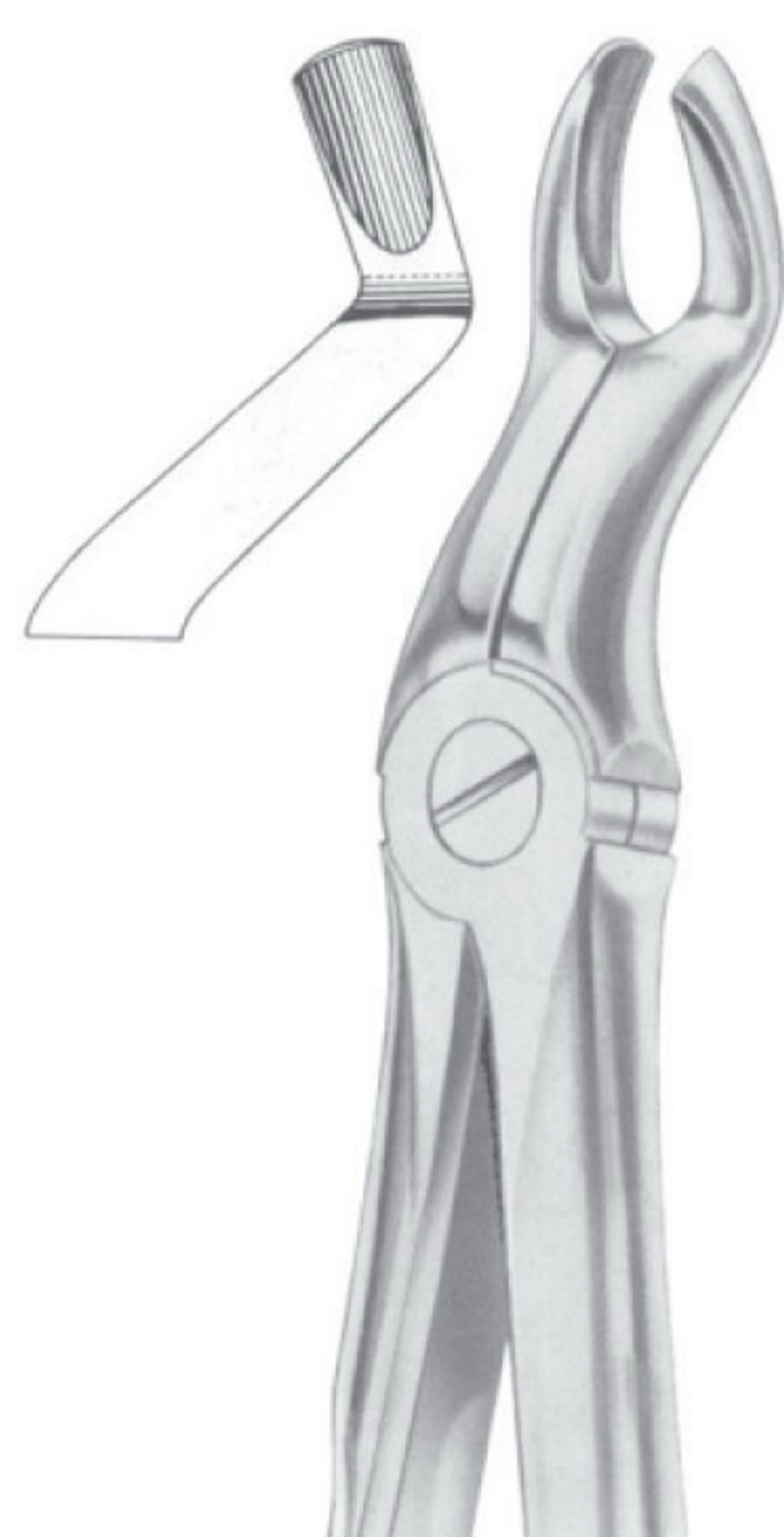

Fig. 67A upper third molars
MWD-1186
Fig. 67A upper third molars



Fig. 67 1/2 R upper third molars right
MWD-1187
Fig. 67 1/2 R upper third molars right

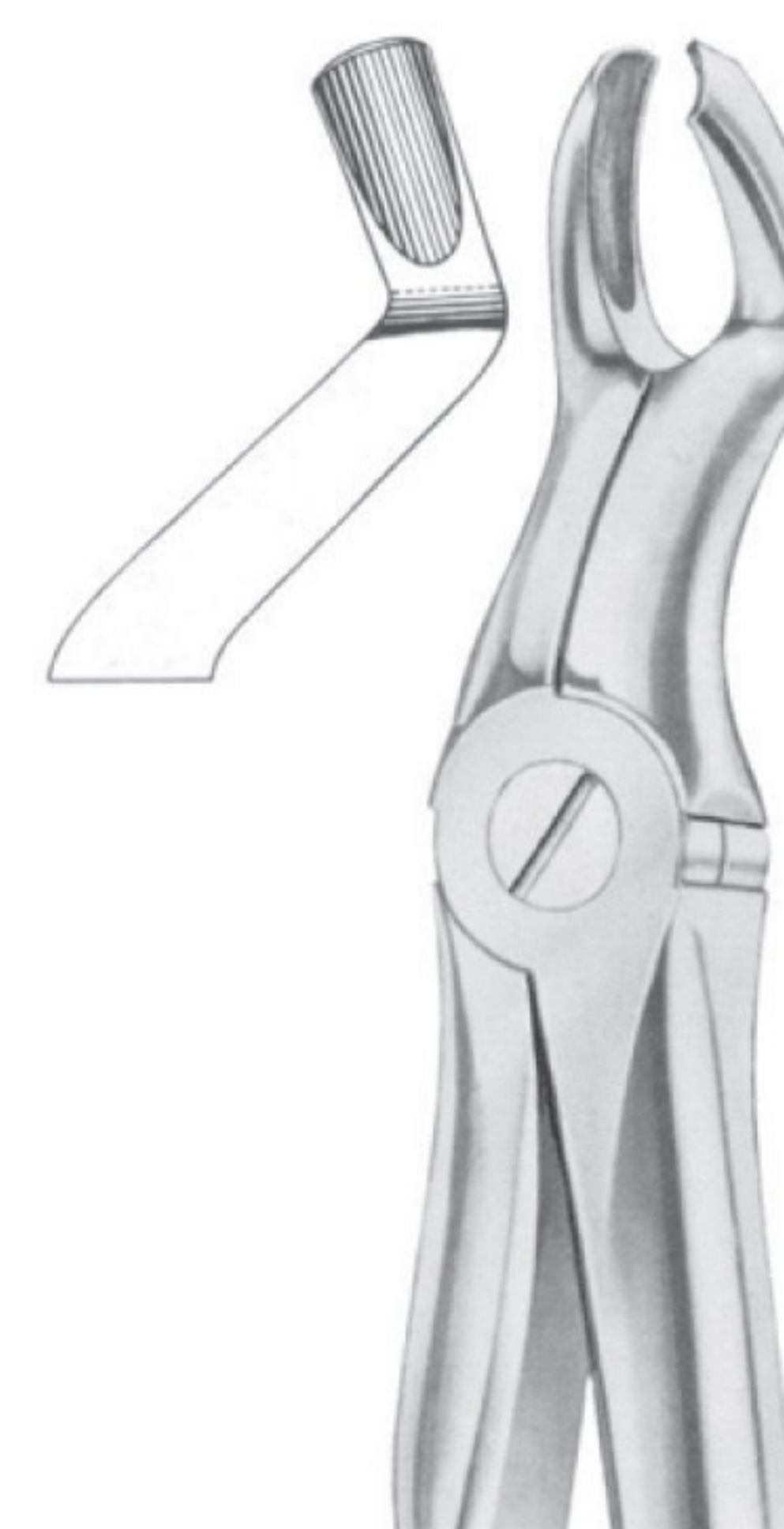

Fig. 67 1/2 L upper third molars left
MWD-1188
Fig. 67 1/2 L upper third molars left

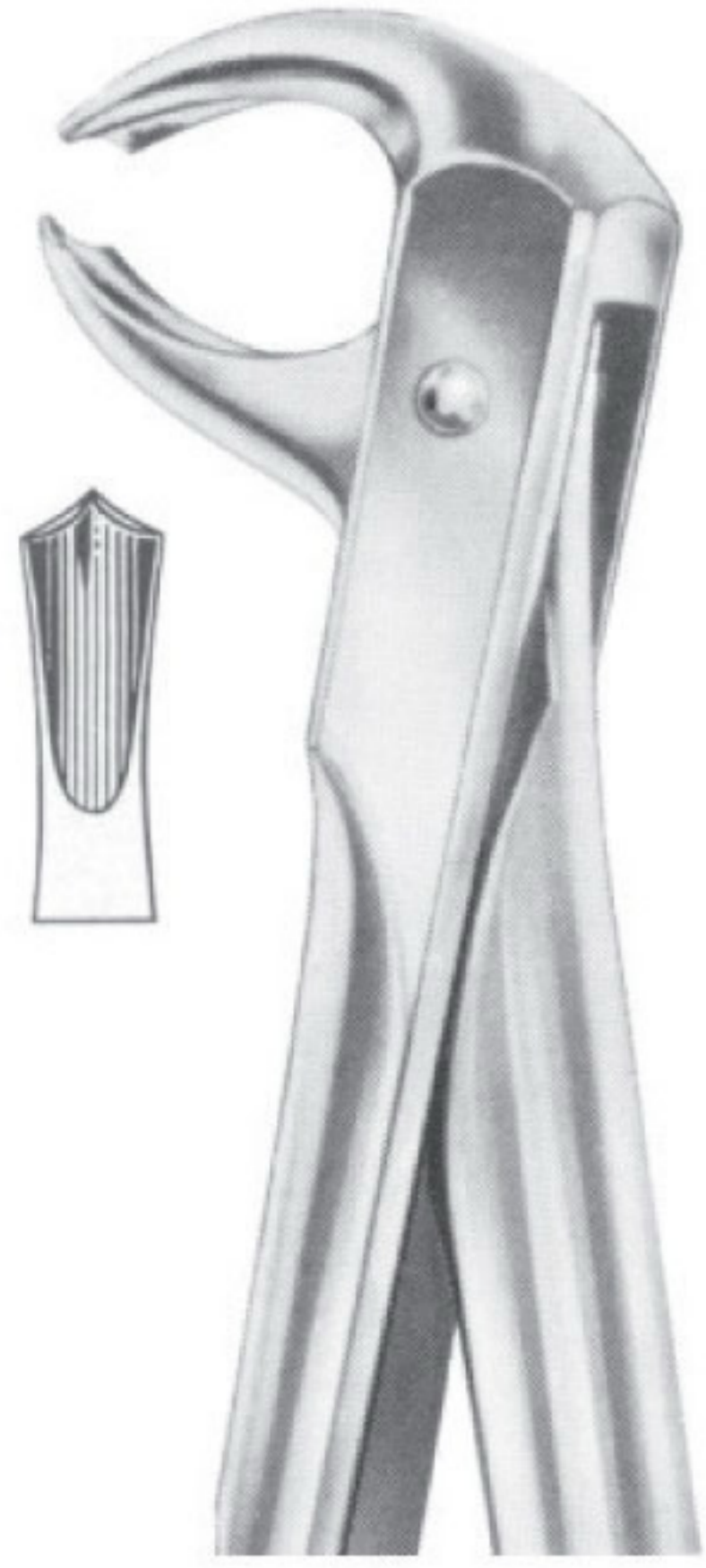

Fig. 73 lower molars
MWD-1189
 Fig. 73 lower molars

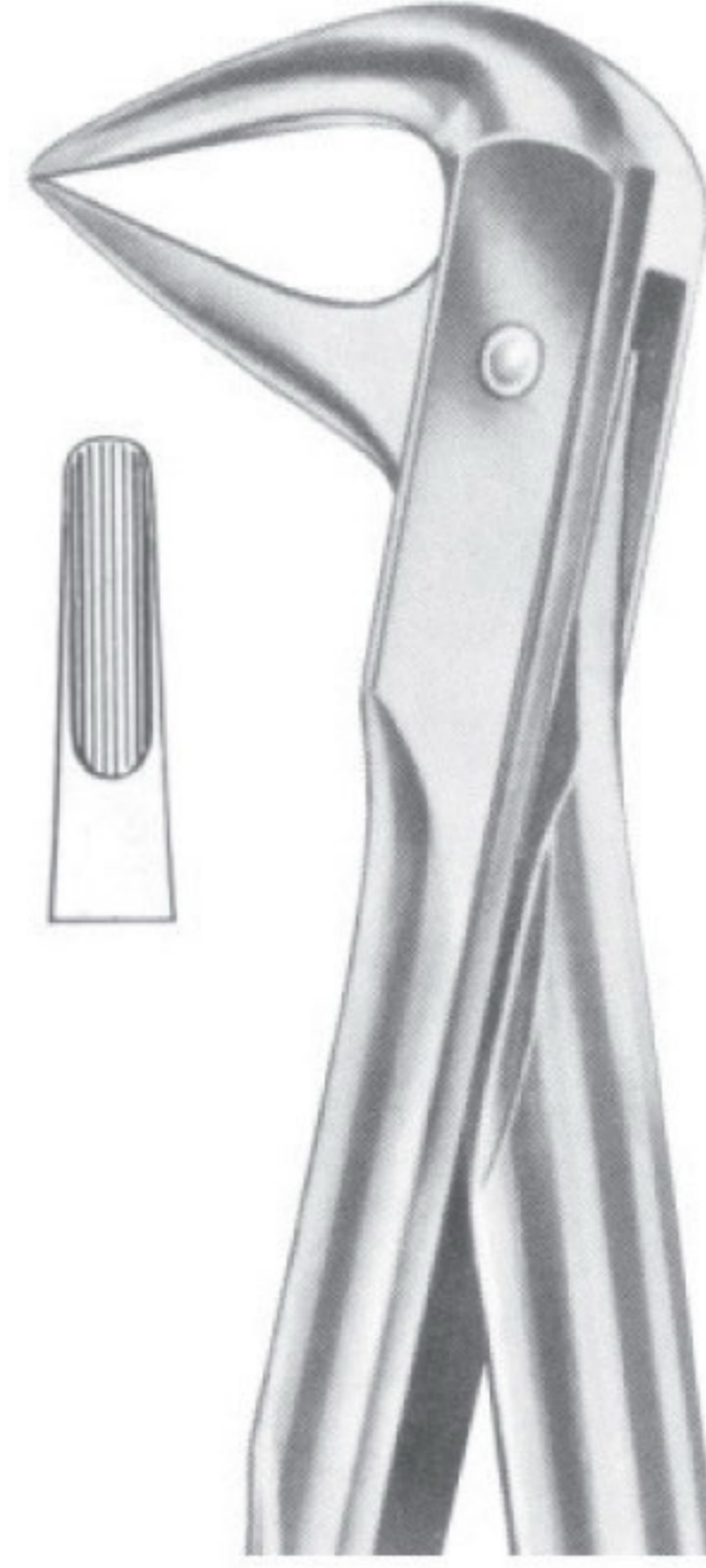

Fig. 74 lower roots
MWD-1190
 Fig. 74 lower roots

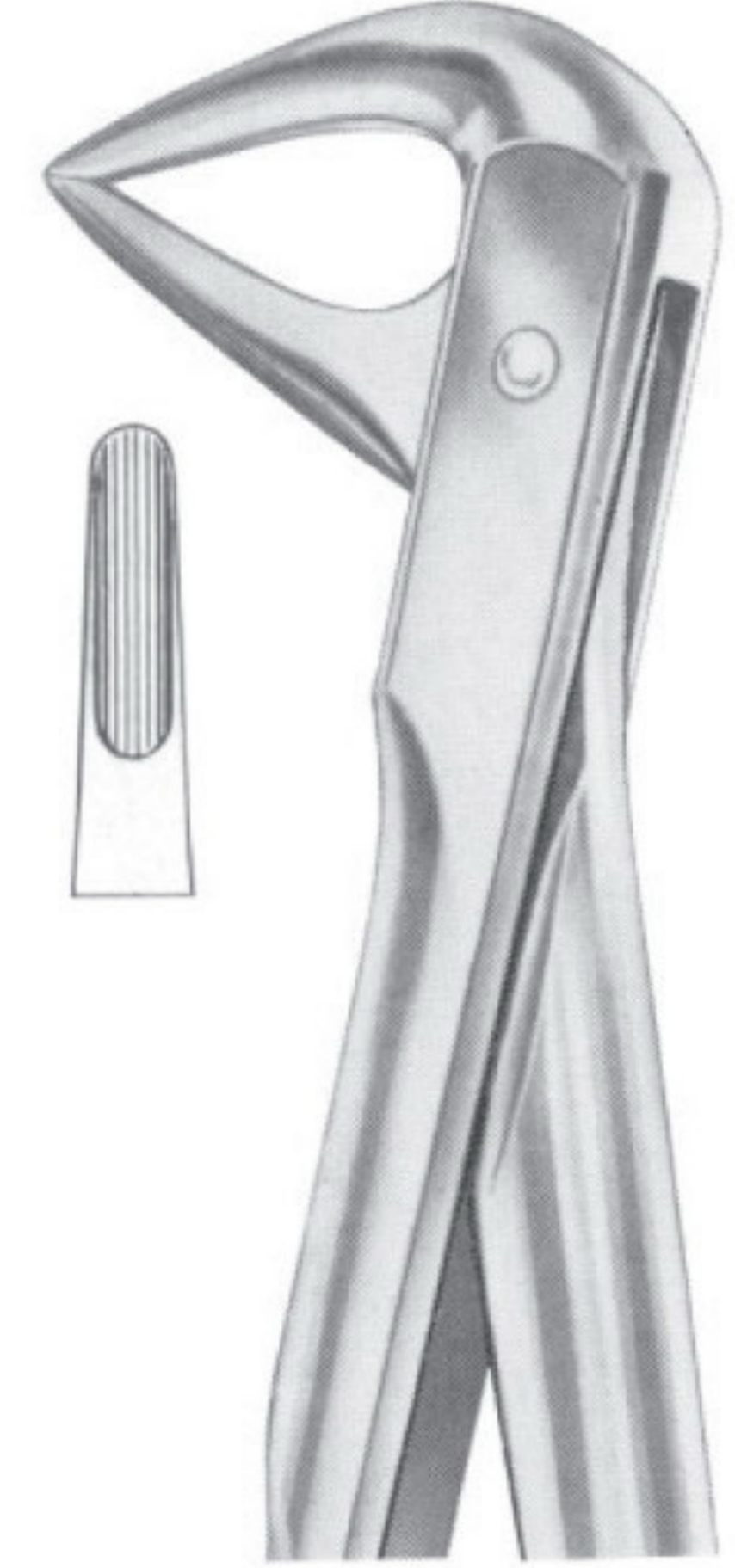

Fig. 74M lower roots
MWD-1191
 Fig. 74M lower roots

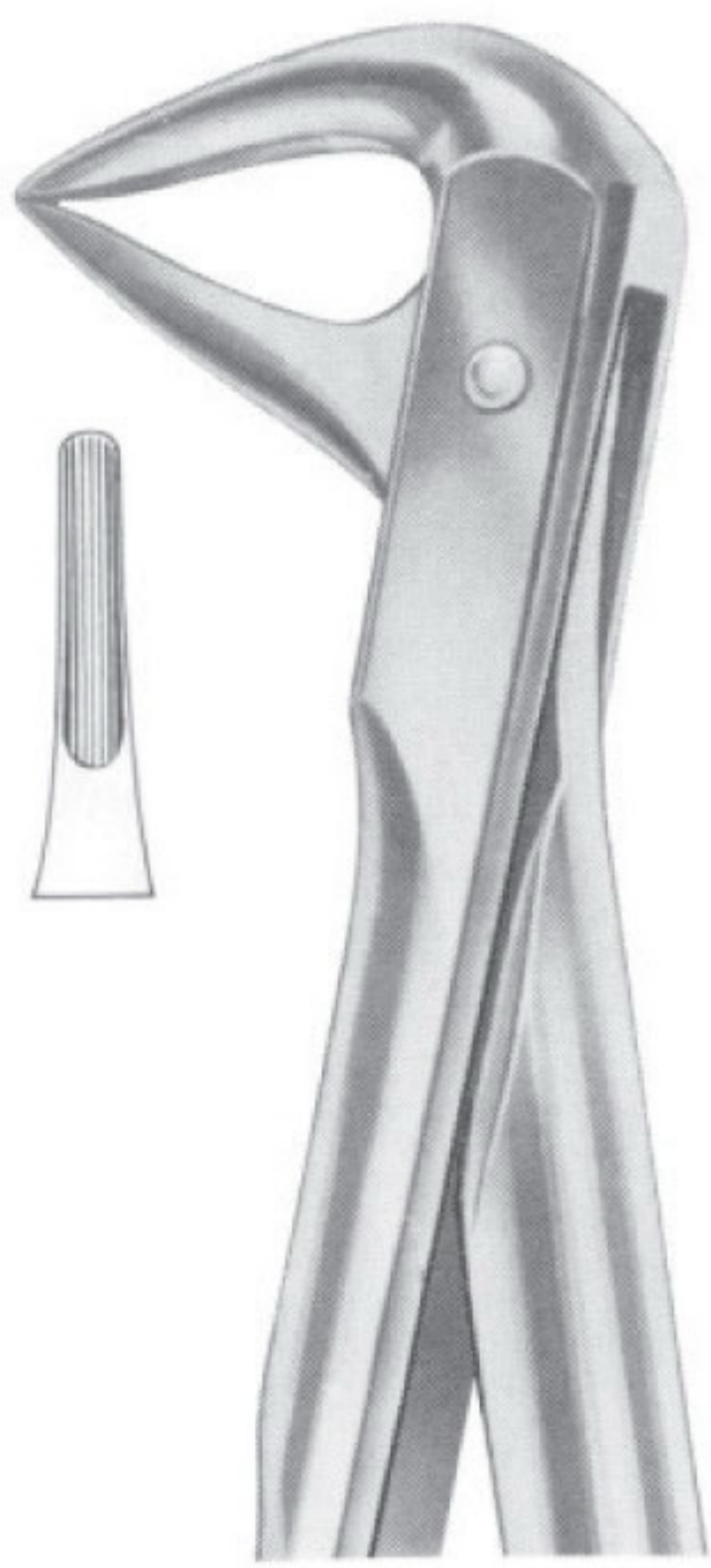

Fig. 74N lower roots
MWD-1192
 Fig. 74N lower roots



Fig. 74XN lower roots and crowded incisors
MWD-1193
 Fig. 74XN lower roots and crowded incisors



Fig. 75 lower premolars
MWD-1194
 Fig. 75 lower premolars



Fig. 76 upper roots
MWD-1195
Fig. 76 upper roots



Fig. 76N upper roots
MWD-1196
Fig. 76N upper roots

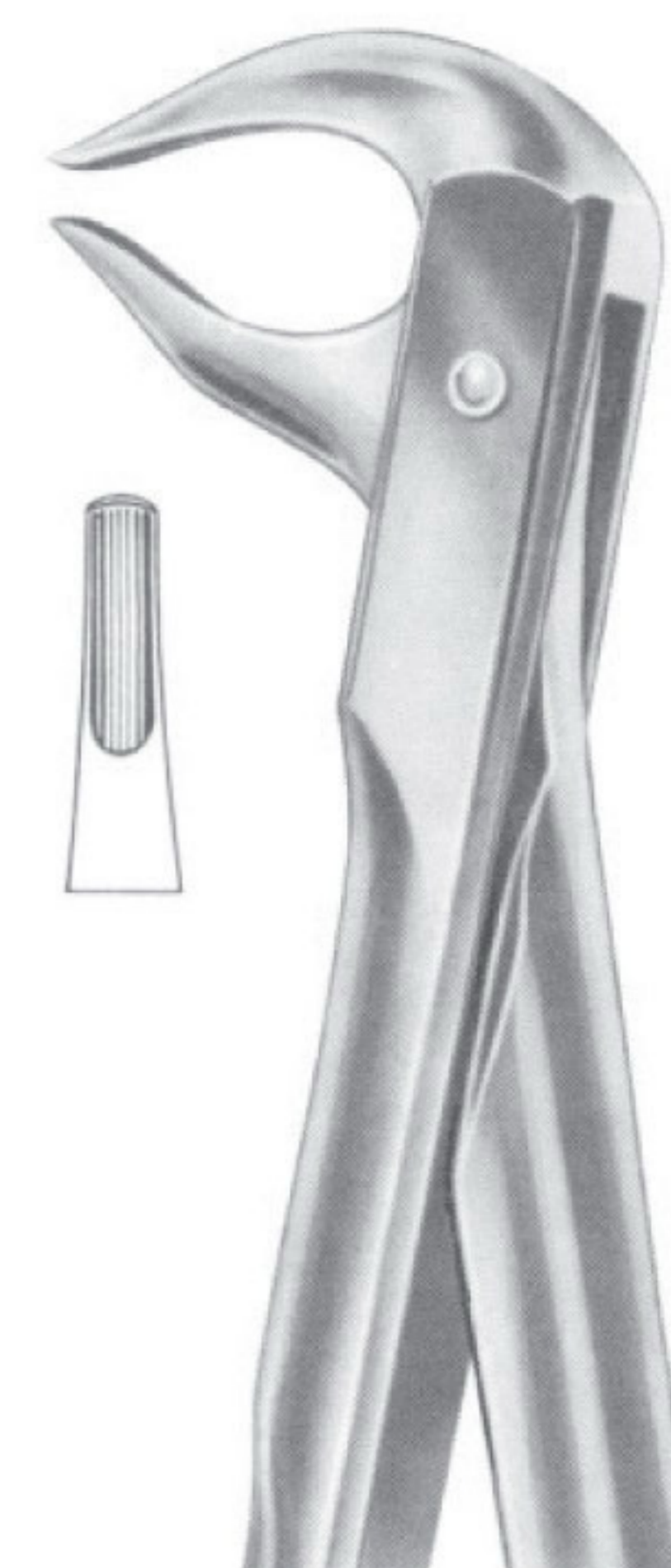

Fig. 81 lower premolars and roots
MWD-1197
Fig. 81 lower premolars and roots

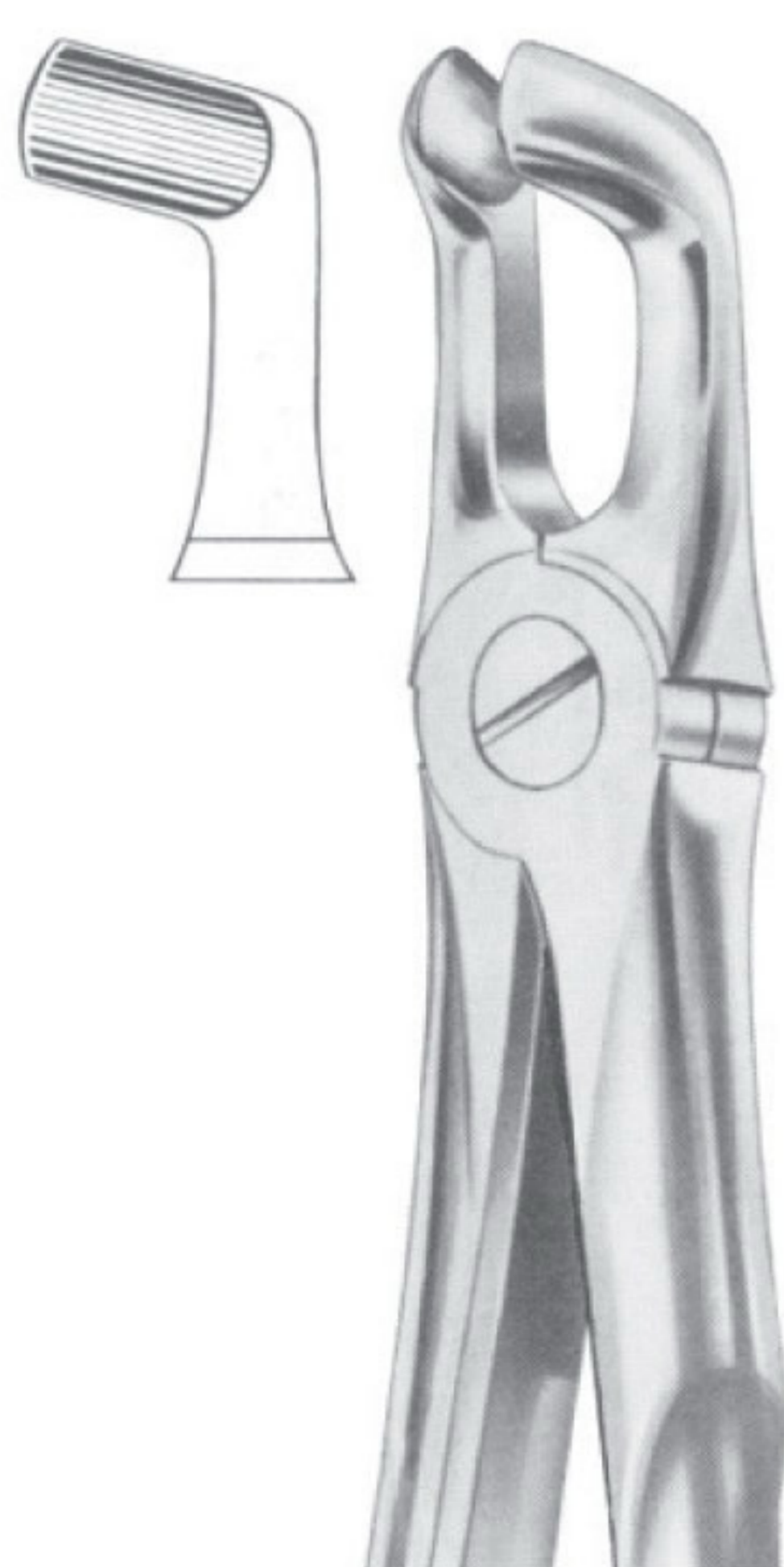

Fig. 76A lower third molars
MWD-1198
Fig. 76A lower third molars



Fig. 79 lower third molars
MWD-1199
Fig. 79 lower third molars



Fig. 86A lower molars
MWD-1200
Fig. 86A lower molars



Fig. 86B lower molars
MWD-1201
Fig. 86B lower molars



Fig. 86C lower molars
MWD-1202
Fig. 86C lower molars

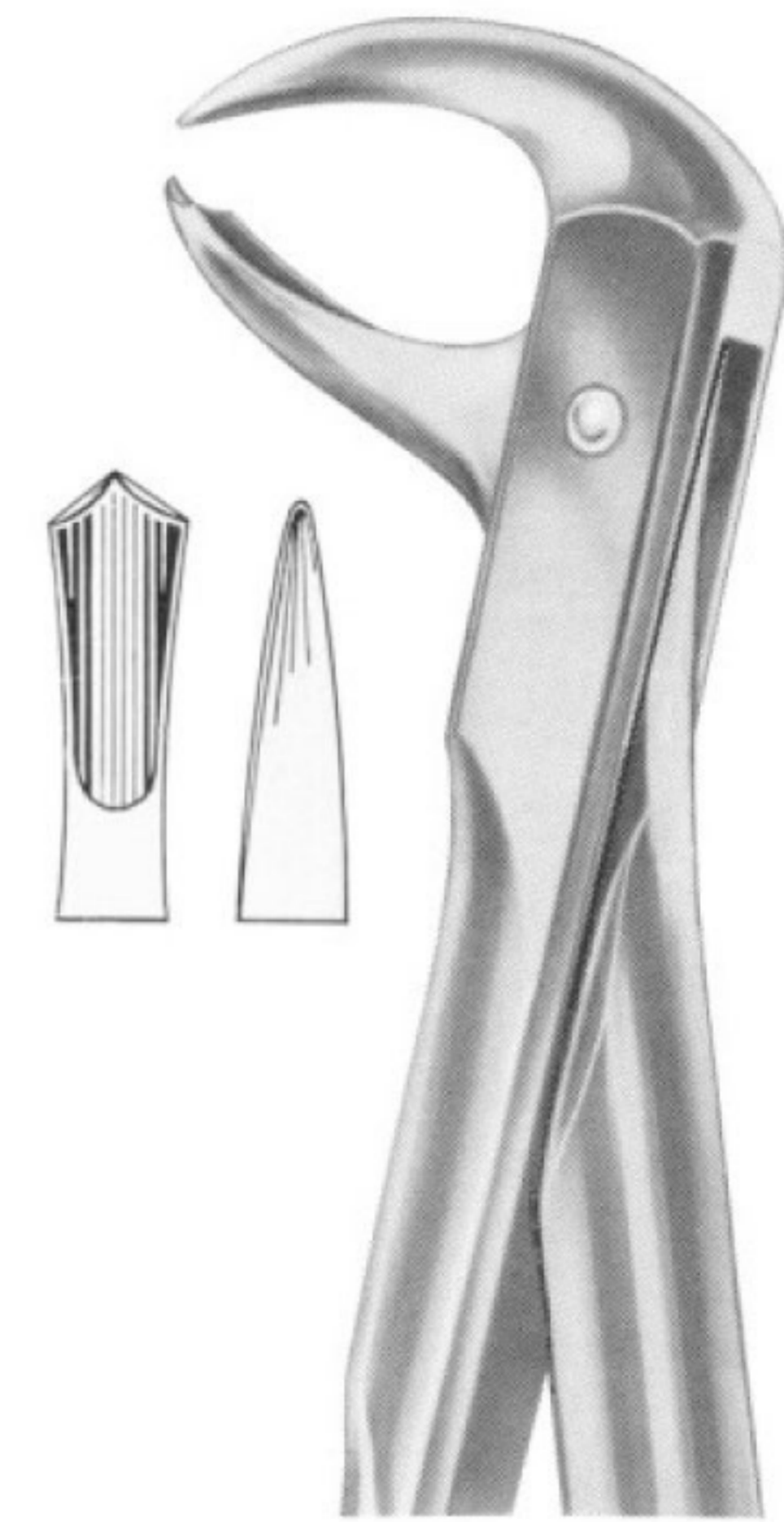

Fig. 99 lower molars
MWD-1203
Fig. 99 lower molars

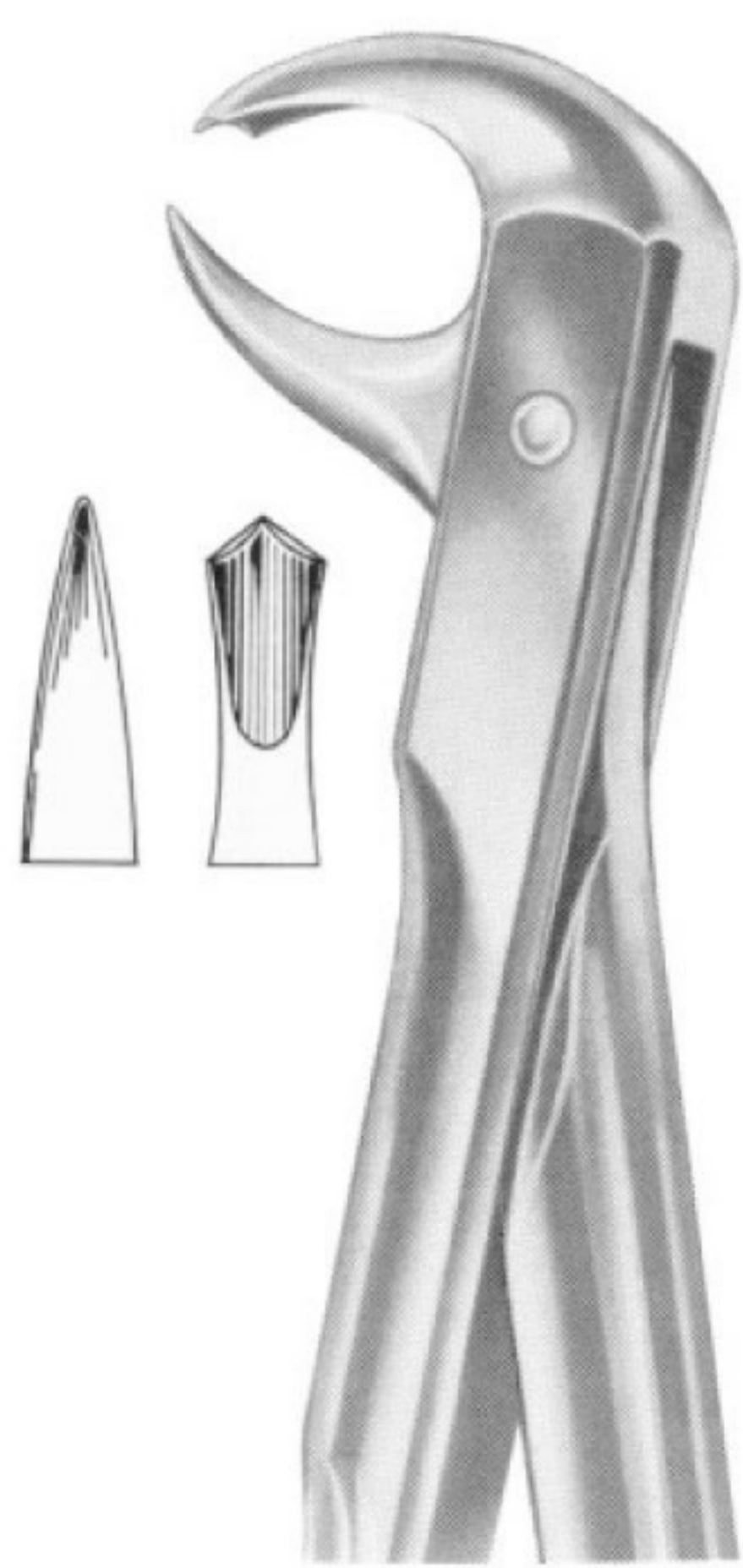

Fig. 99 1/4 lower molars
MWD-1204
Fig. 99 1/4 lower molars

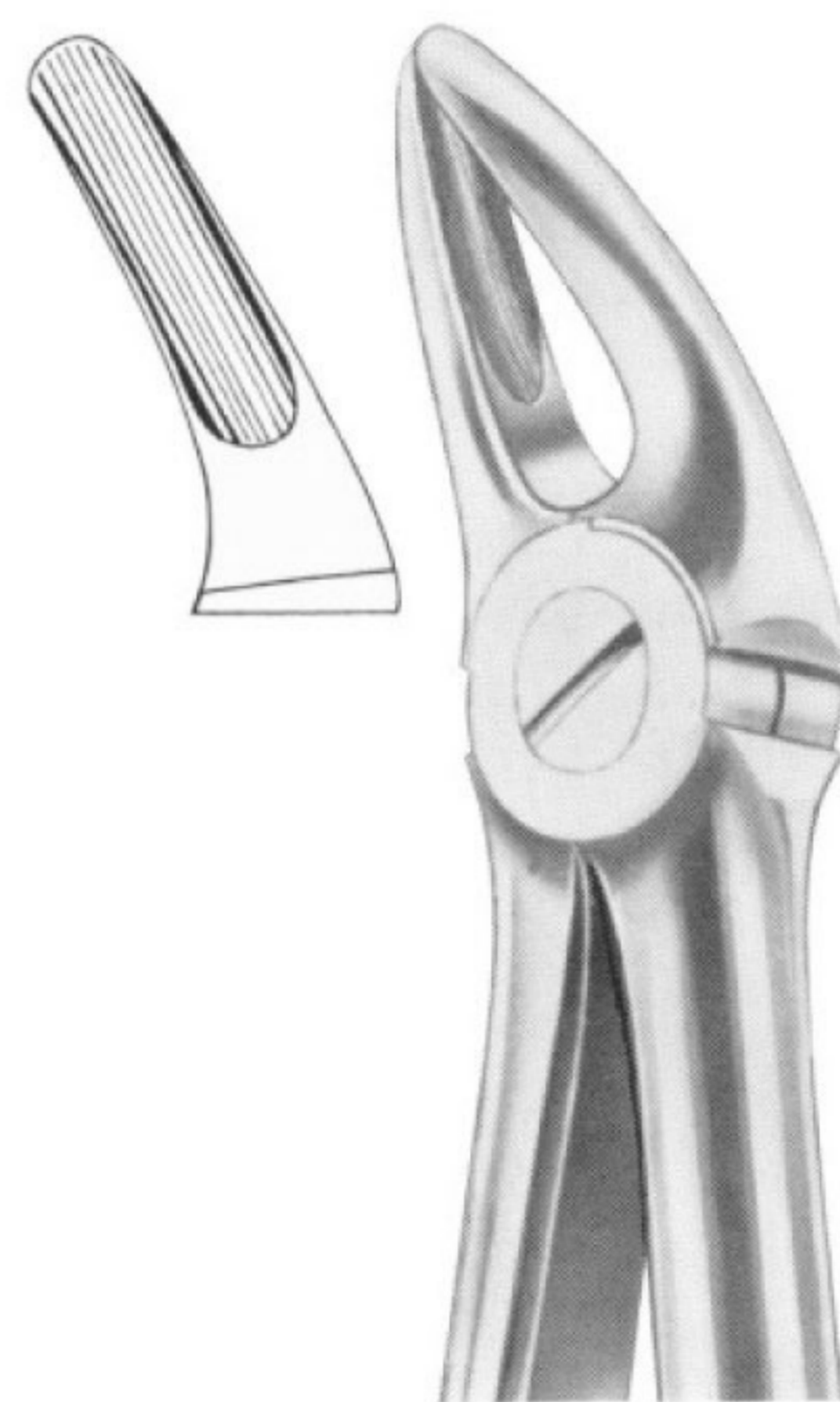

Fig. 136 upper premolars and roots
MWD-1205
Fig. 136 upper premolars and roots

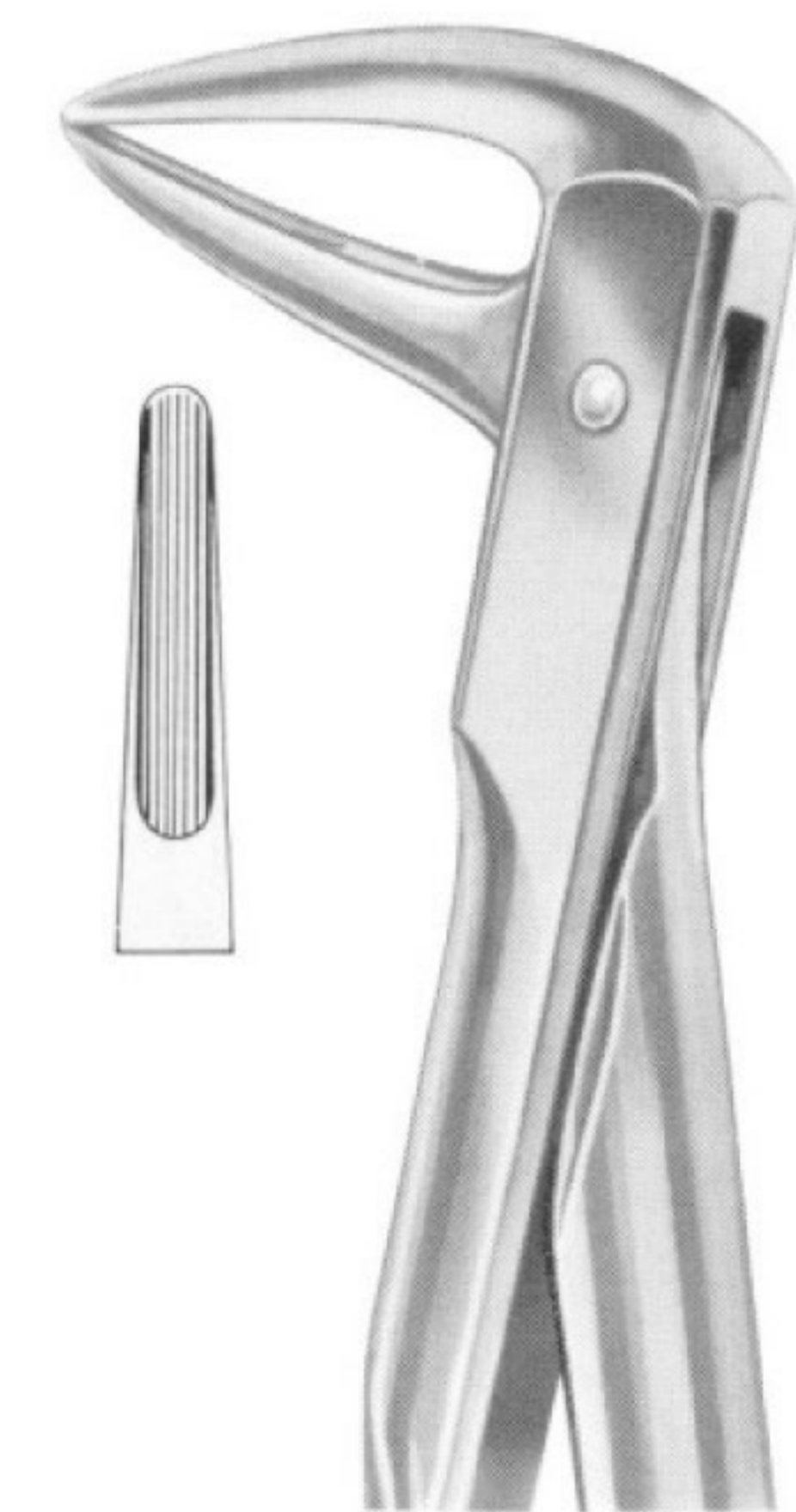

Fig. 143 lower roots
MWD-1206
Fig. 143 lower roots



KLEIN (Fig. 217) upper incisors
MWD-1207
 KLEIN (Fig. 217) upper incisors



KLEIN (Fig. 218) upper premolars
MWD-1208
 KLEIN (Fig. 218) upper premolars



KLEIN (Fig. 219) upper roots
MWD-1209
 KLEIN (Fig. 219) upper roots

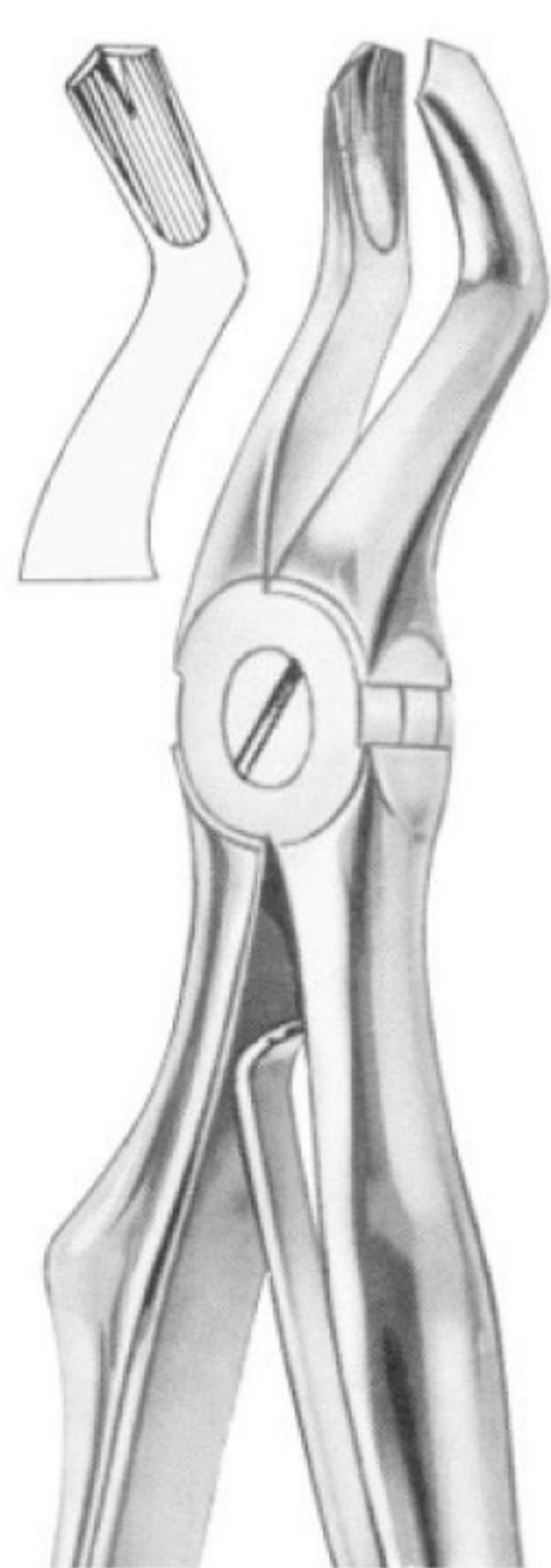

KLEIN (Fig. 220) upper molars
MWD-1210
 KLEIN (Fig. 220) upper molars



KLEIN (Fig. 221) lower incisors
MWD-1211
 KLEIN (Fig. 221) lower incisors

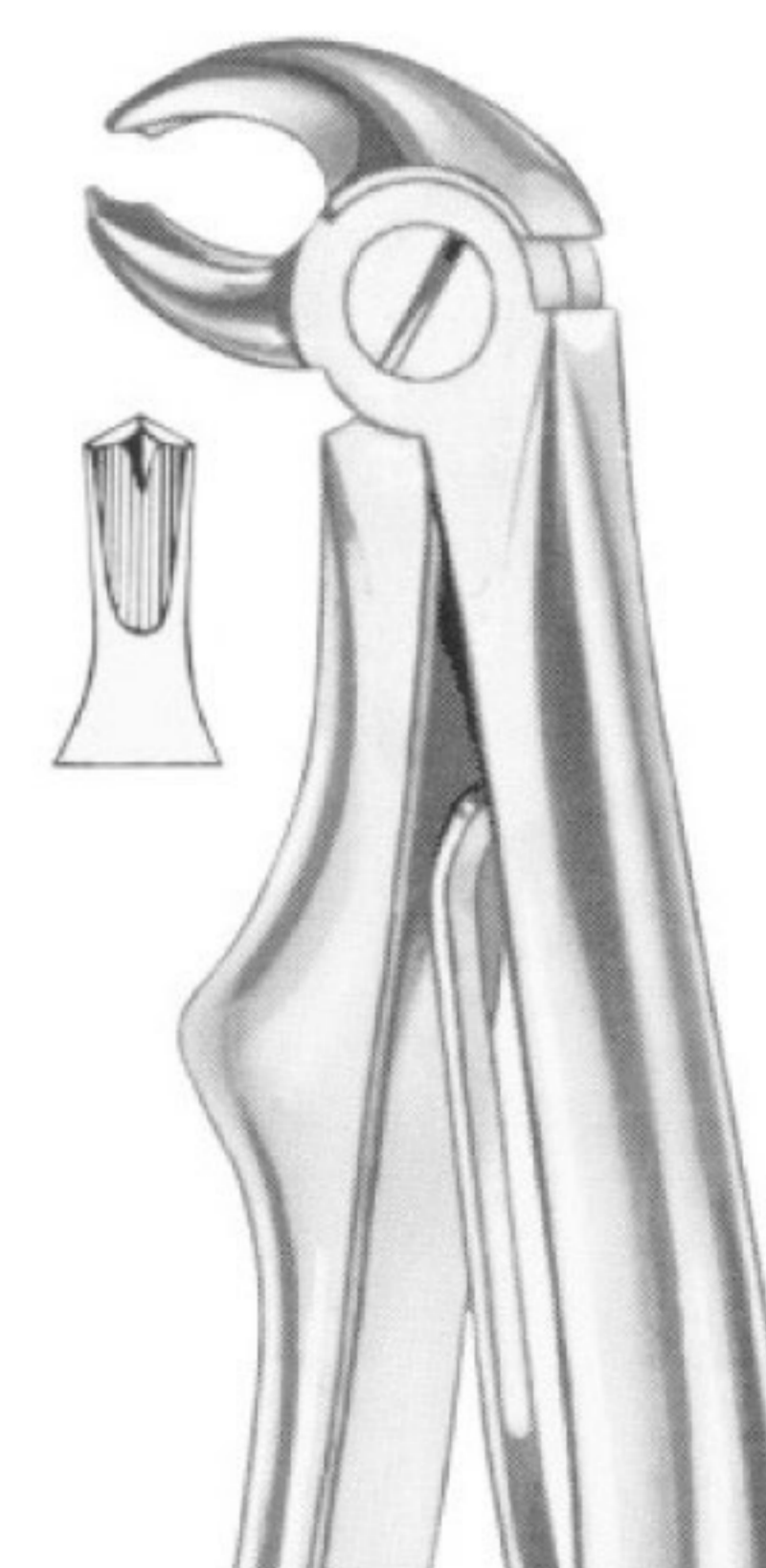

KLEIN (Fig. 222) lower molars
MWD-1212
 KLEIN (Fig. 222) lower molars

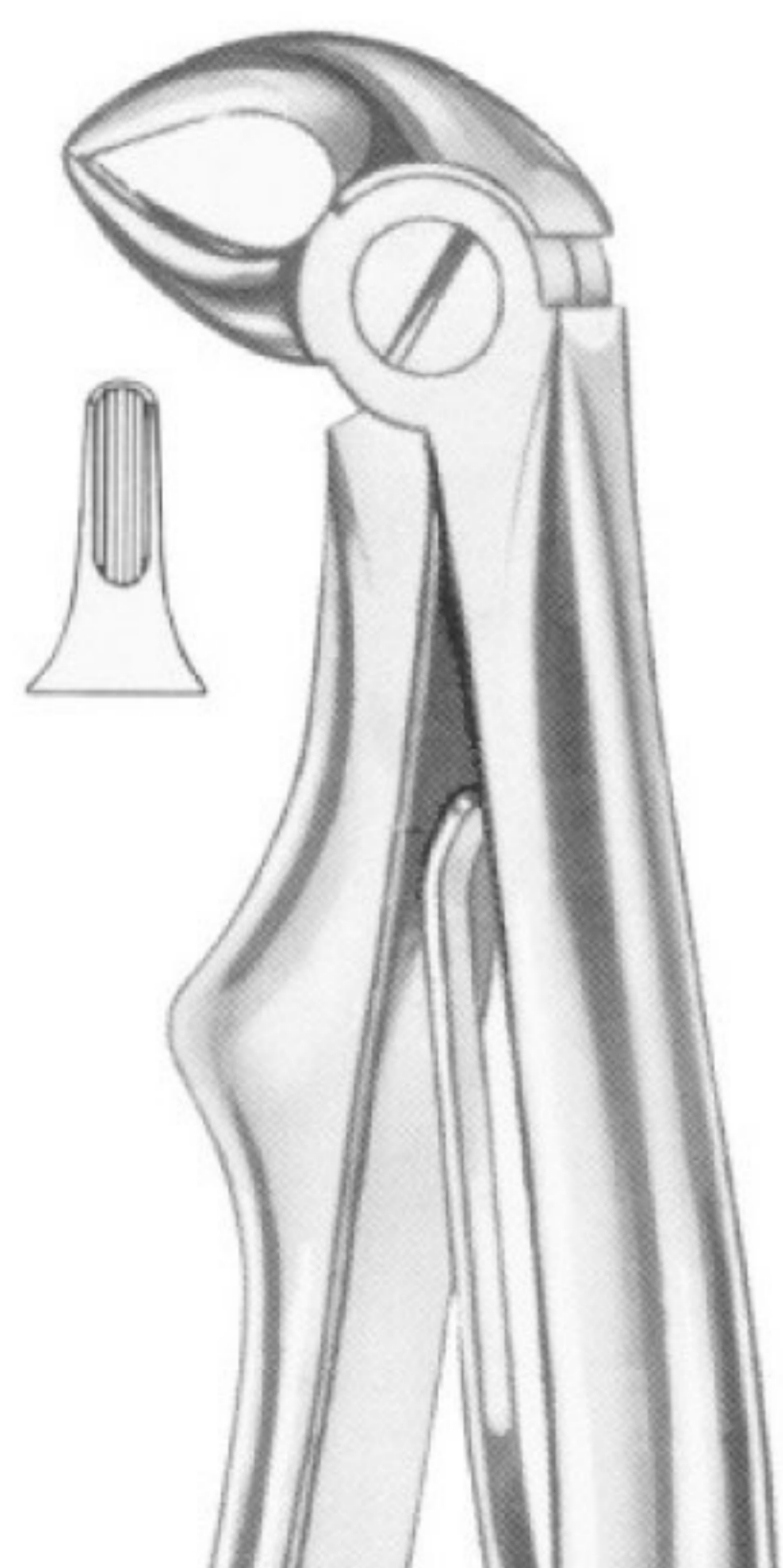

KLEIN (Fig. 223) lower roots
MWD-1213
 KLEIN (Fig. 223) lower roots



ALBRECHT Fig. 224 Deciduous
MWD-1214
 ALBRECHT Fig. 224 Deciduous



ALBRECHT Fig. 225 Deciduous
MWD-1215
 ALBRECHT Fig. 225 Deciduous



WITZEL Fig. 226 lower roots
MWD-1216
 WITZEL Fig. 226 lower roots

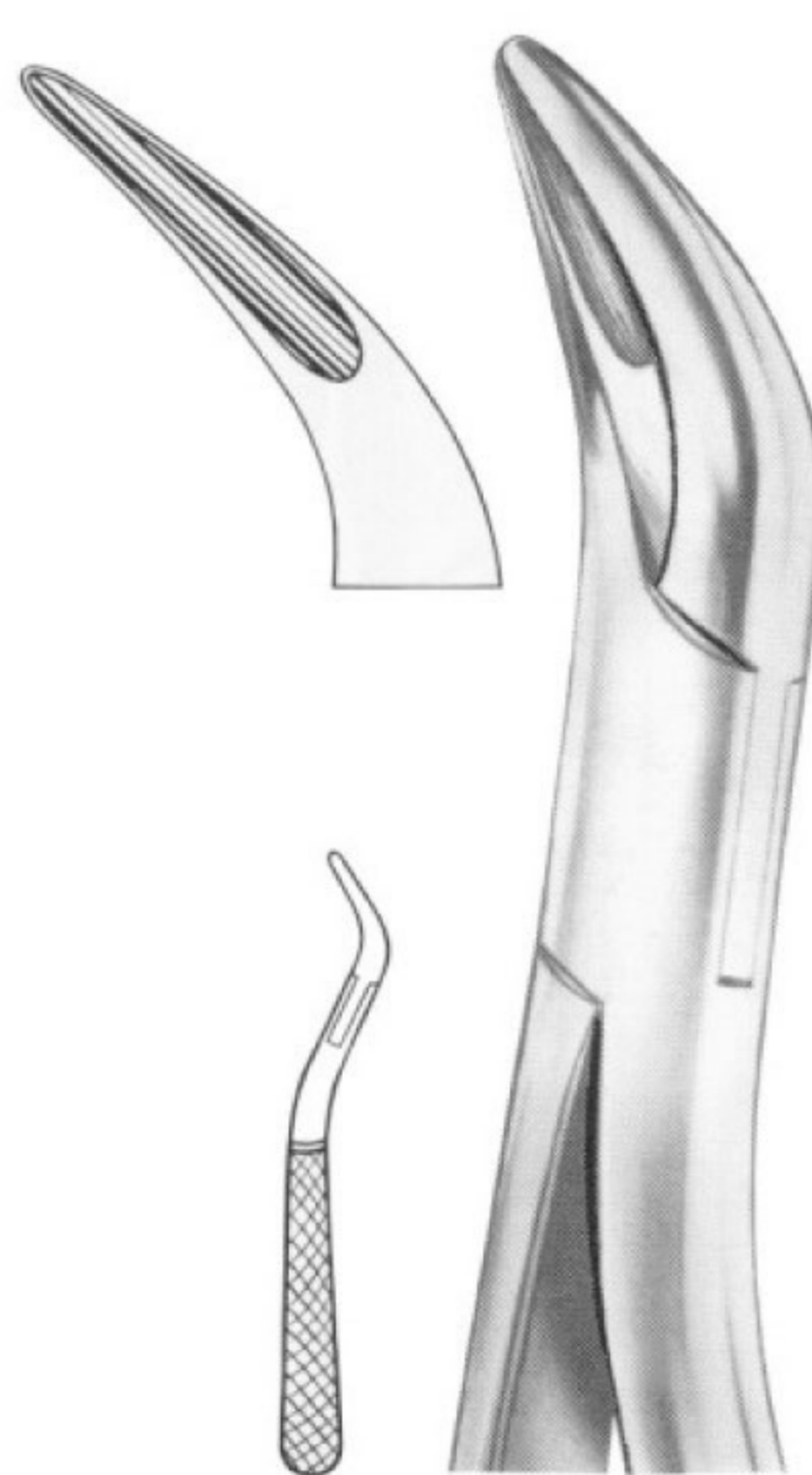

WITZEL Fig. 227 upper roots
MWD-1217
 WITZEL Fig. 227 upper roots



ARTHUR Fig. 228 root fragments
MWD-1218
 ARTHUR Fig. 228 root fragments



STIEGLITZ Fig. 229 root fragments
MWD-1219
 STIEGLITZ Fig. 229 root fragments

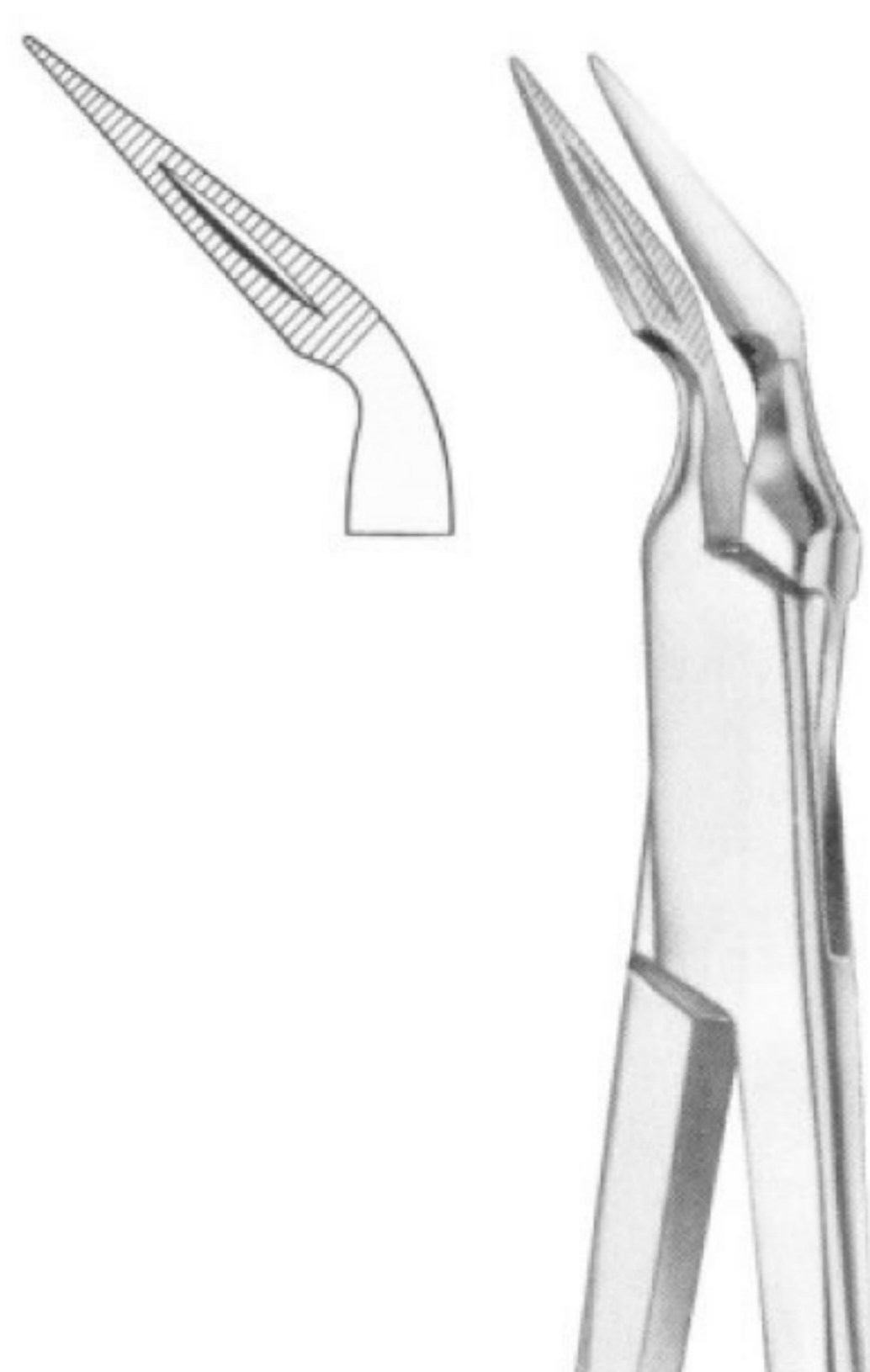

STIEGLITZ Fig. 230 root fragments
MWD-1220
 STIEGLITZ Fig. 230 root fragments



RALK Fig. 231 root fragments
MWD-1221
 RALK Fig. 231 root fragments



W1-WINTER upper centrals and canines
MWD-1222
 W1-WINTER upper centrals and canines

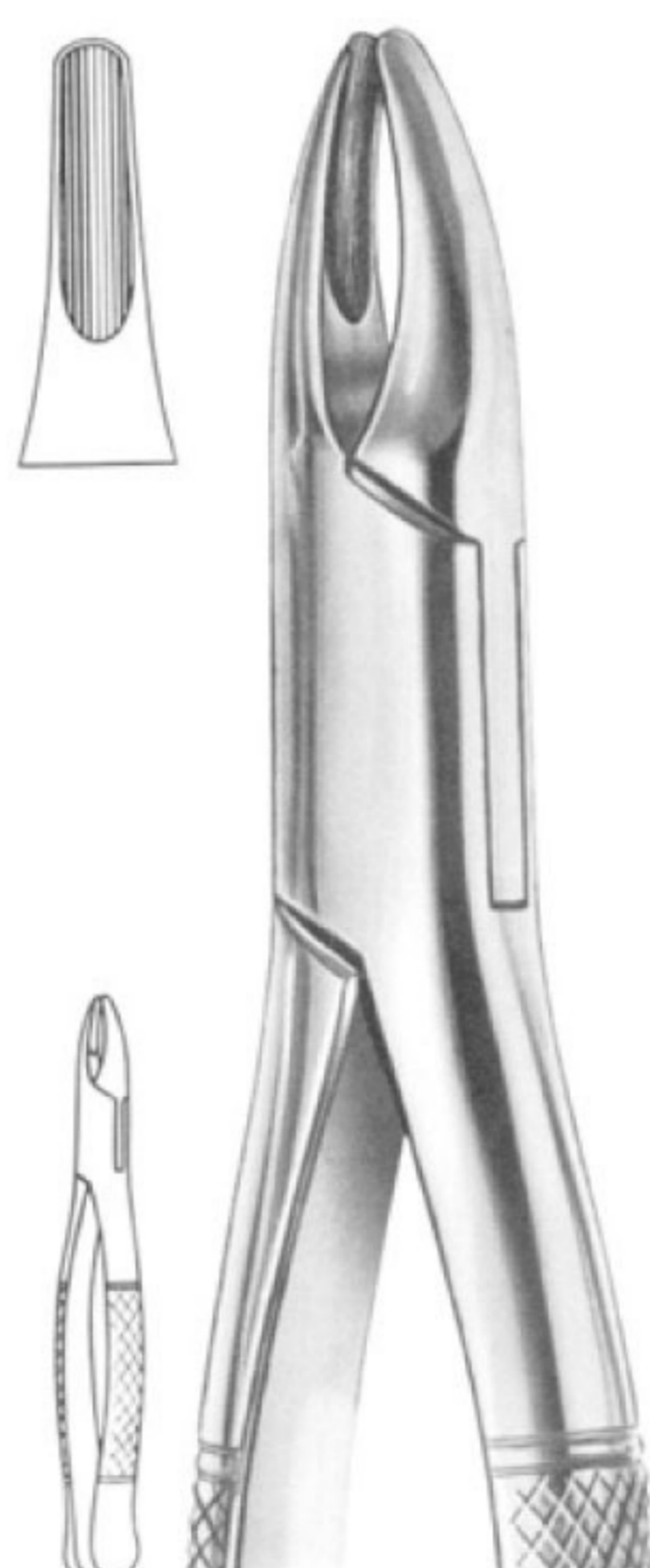

Fig. 1 upper incisors and roots
MWD-1223
 Fig. 1 upper incisors and roots

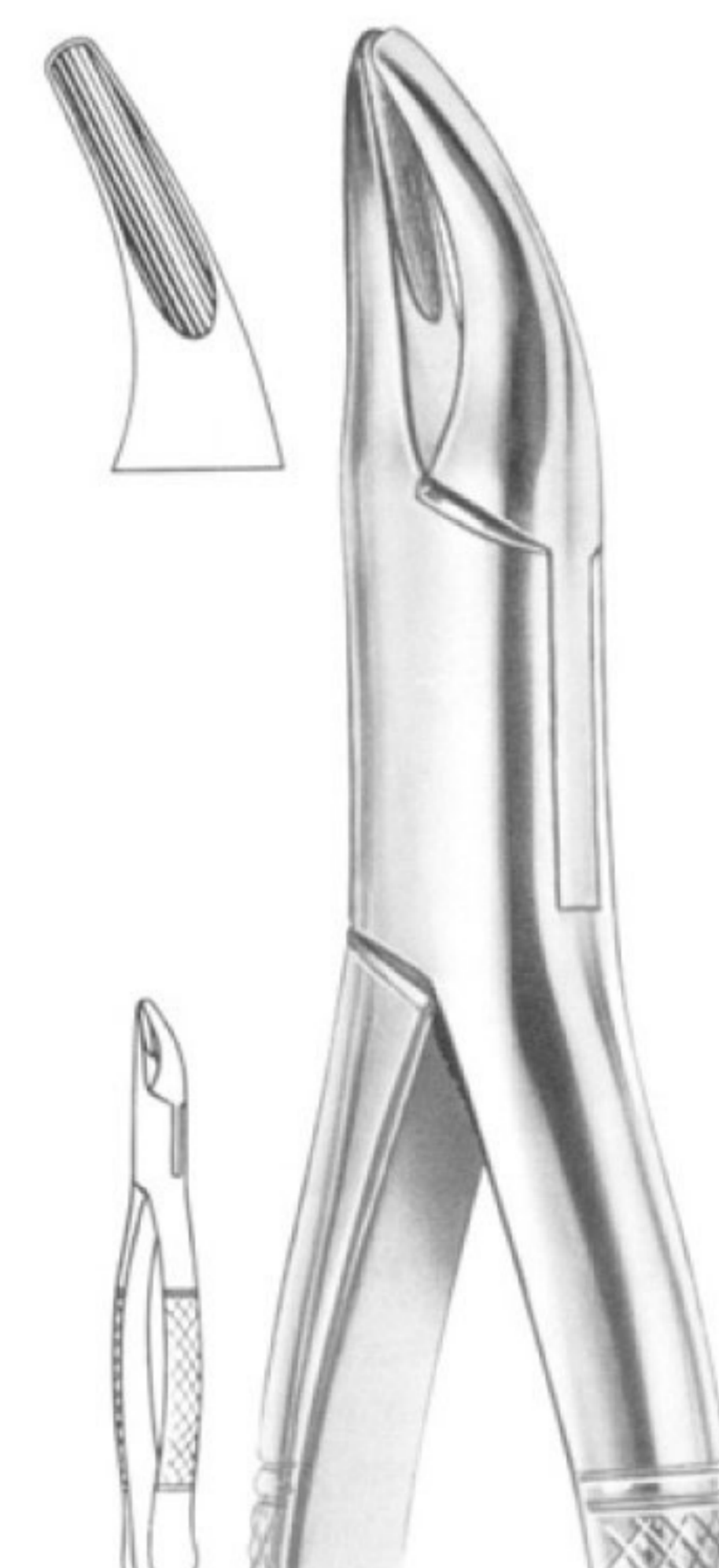

Fig. 2 upper and lower roots
MWD-1224
 Fig. 2 upper and lower roots

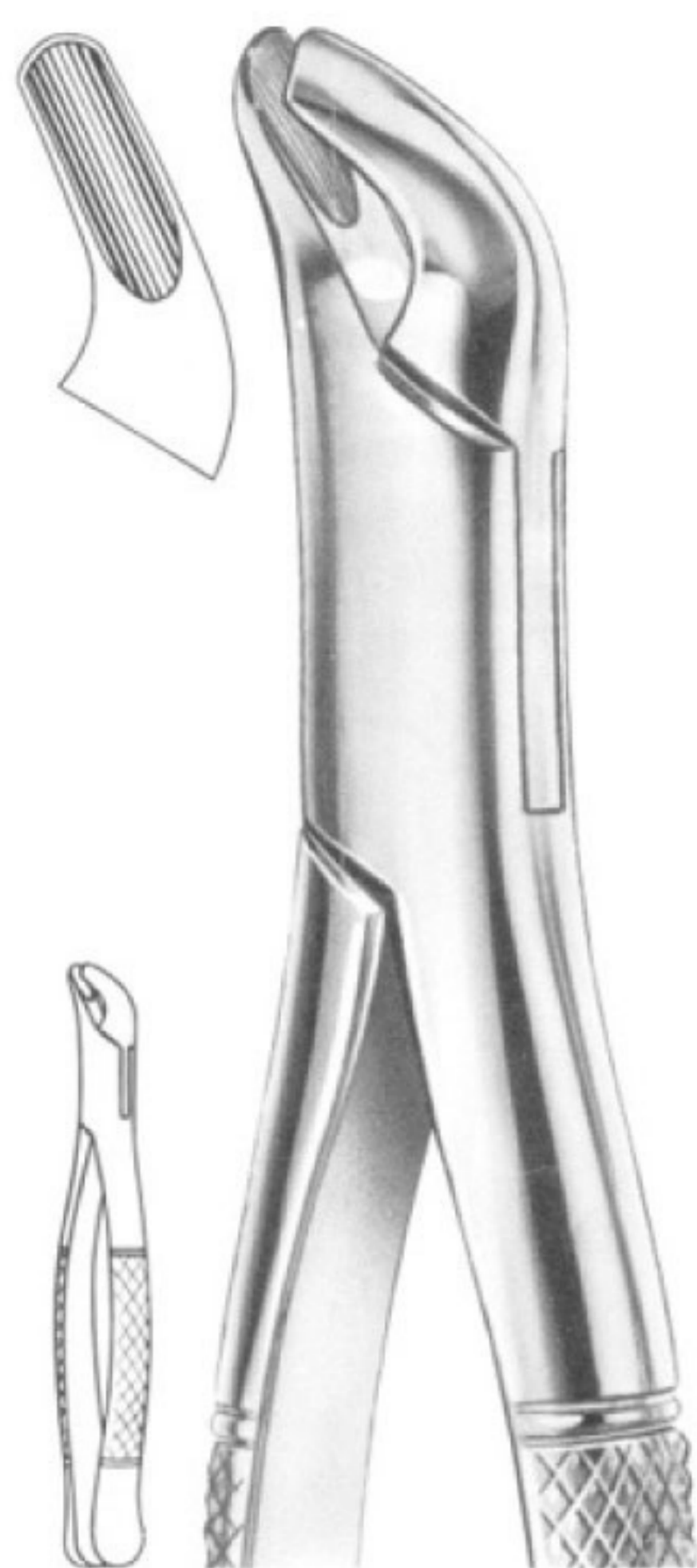
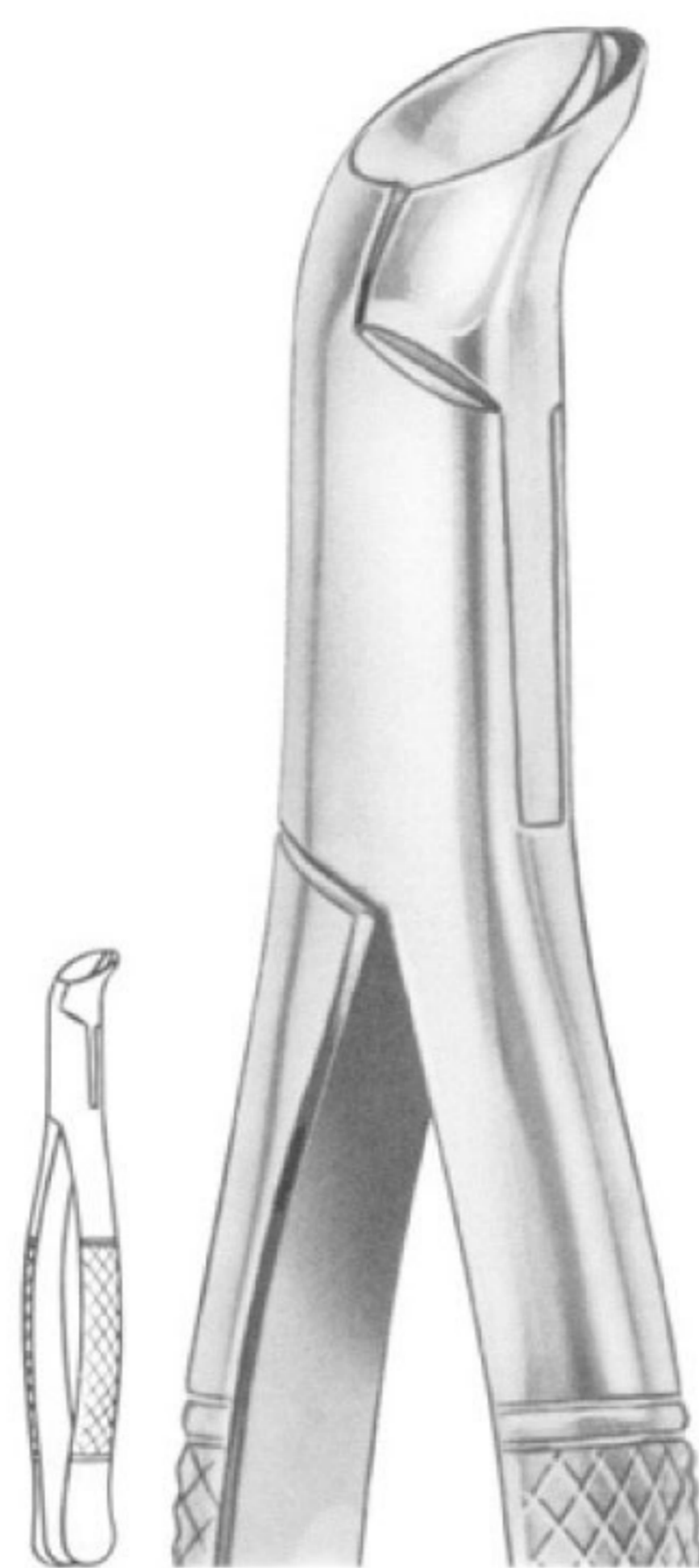

Fig. 4 upper and lower premolars
MWD-1225
 Fig. 4 upper and lower premolars



PHYSICK Fig. 5 lower third molars
MWD-1226
 PHYSICK Fig. 5 lower third molars



Fig. 6 separating forceps
MWD-1227
 Fig. 6 separating forceps



Fig. 7 upper roots
MWD-1228
 Fig. 7 upper roots

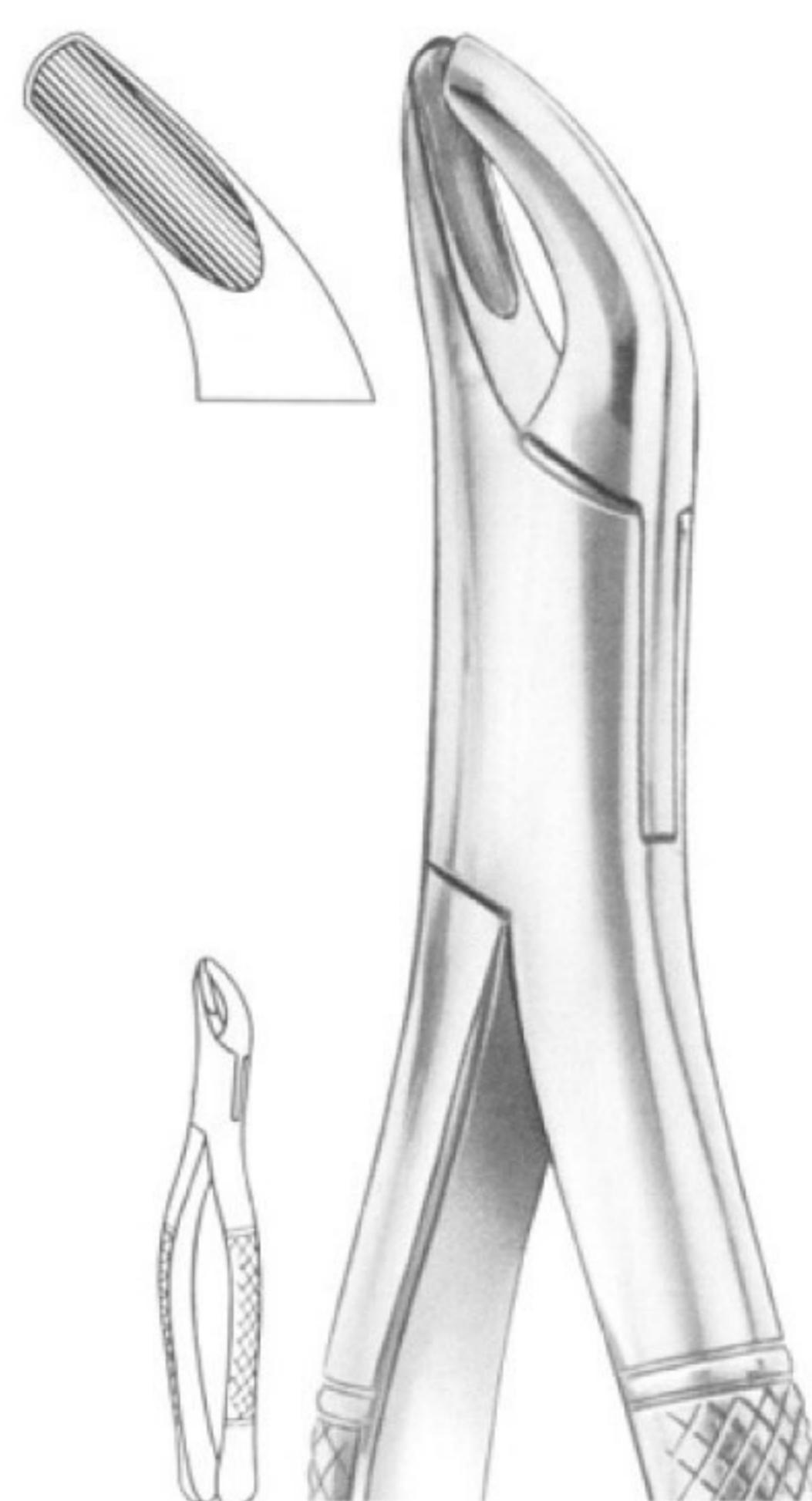

Fig. 8 upper and lower third molars
MWD-1229
 Fig. 8 upper and lower third molars

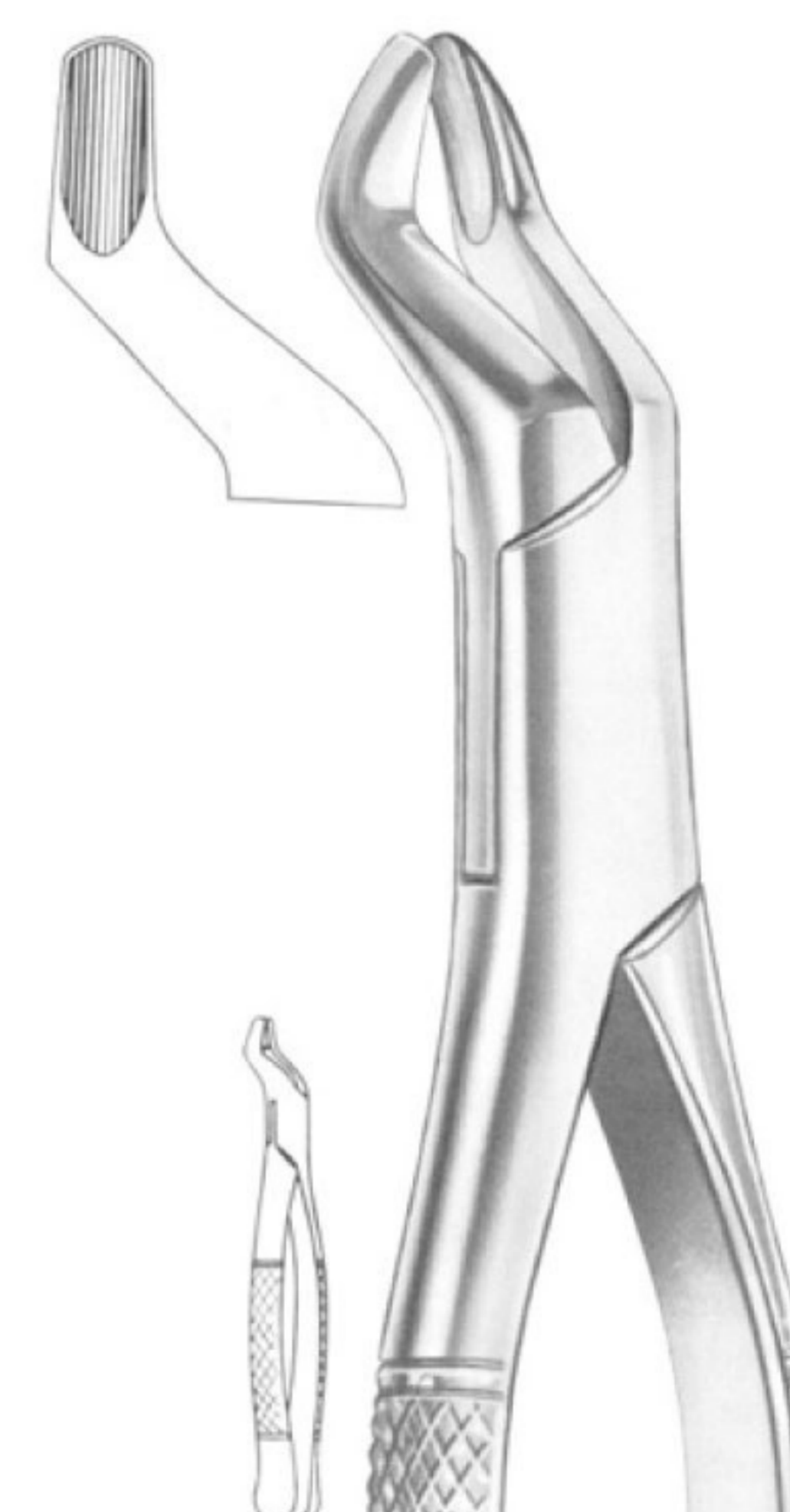

Fig. 10S upper molars
MWD-1230
 Fig. 10S upper molars



Fig. 10H upper molars
MWD-1231
Fig. 10H upper molars

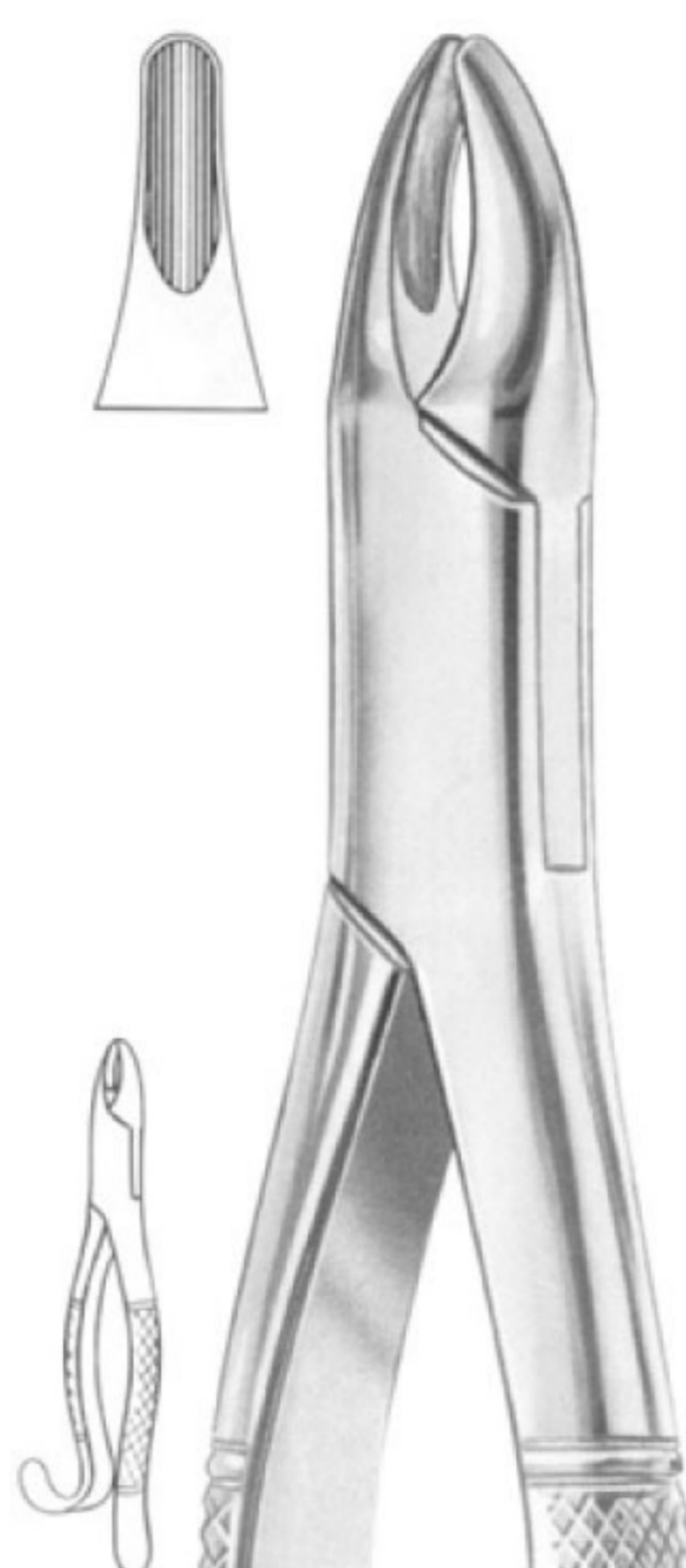

Fig. 13 upper incisors
MWD-1232
Fig. 13 upper incisors

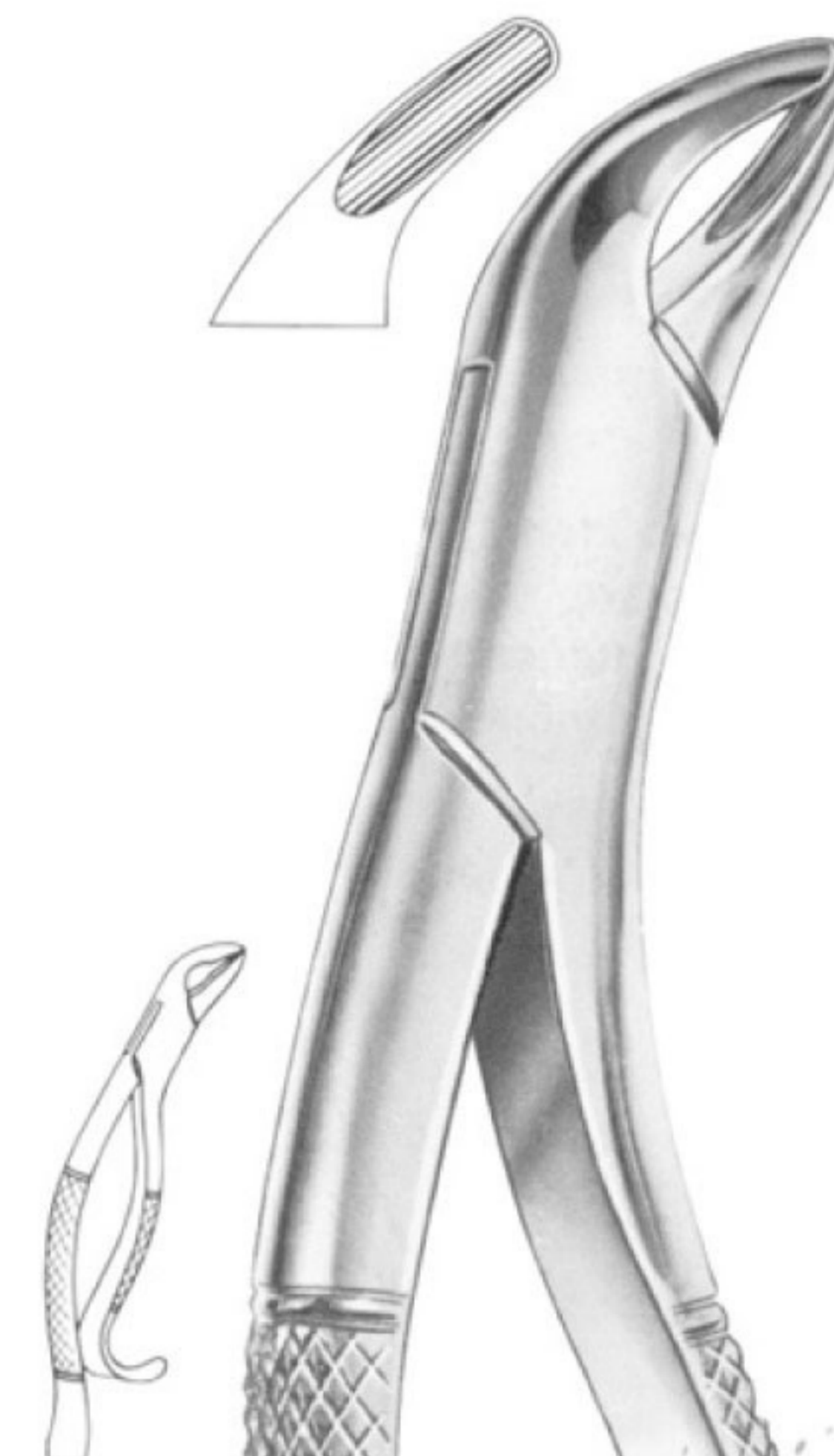

Fig. 14 lower incisors
MWD-1233
Fig. 14 lower incisors



Fig. 16 lower molars
MWD-1234
Fig. 16 lower molars



HARRIS Fig. 15 lower molars
MWD-1235
HARRIS Fig. 15 lower molars

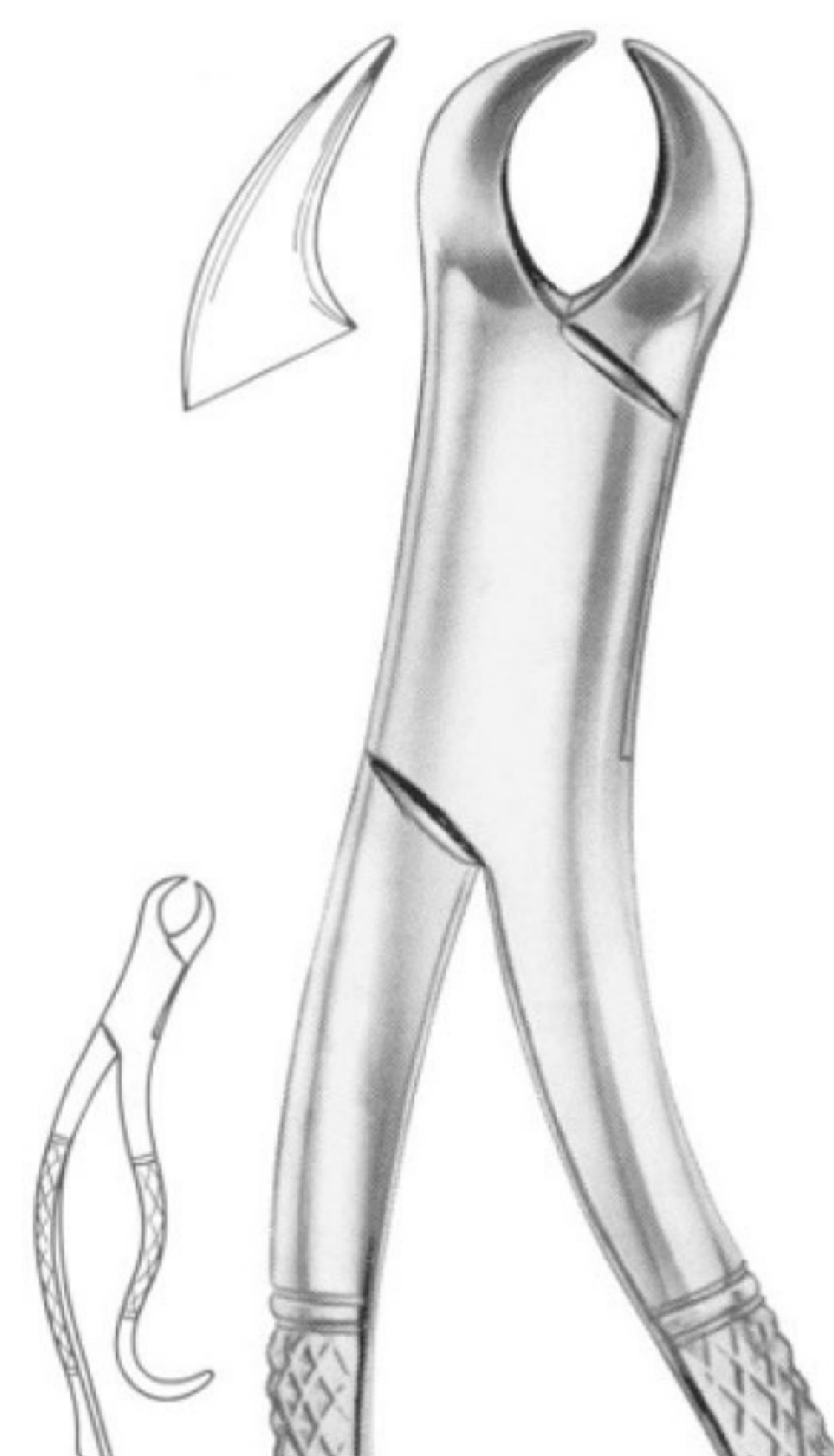

Fig. 16S lower molars for children
MWD-1236
Fig. 16S lower molars for children



HARRIS Fig. 18R upper molars right
MWD-1237
 HARRIS Fig. 18R upper molars right



HARRIS Fig. 18L upper molars left
MWD-1238
 HARRIS Fig. 18L upper molars left

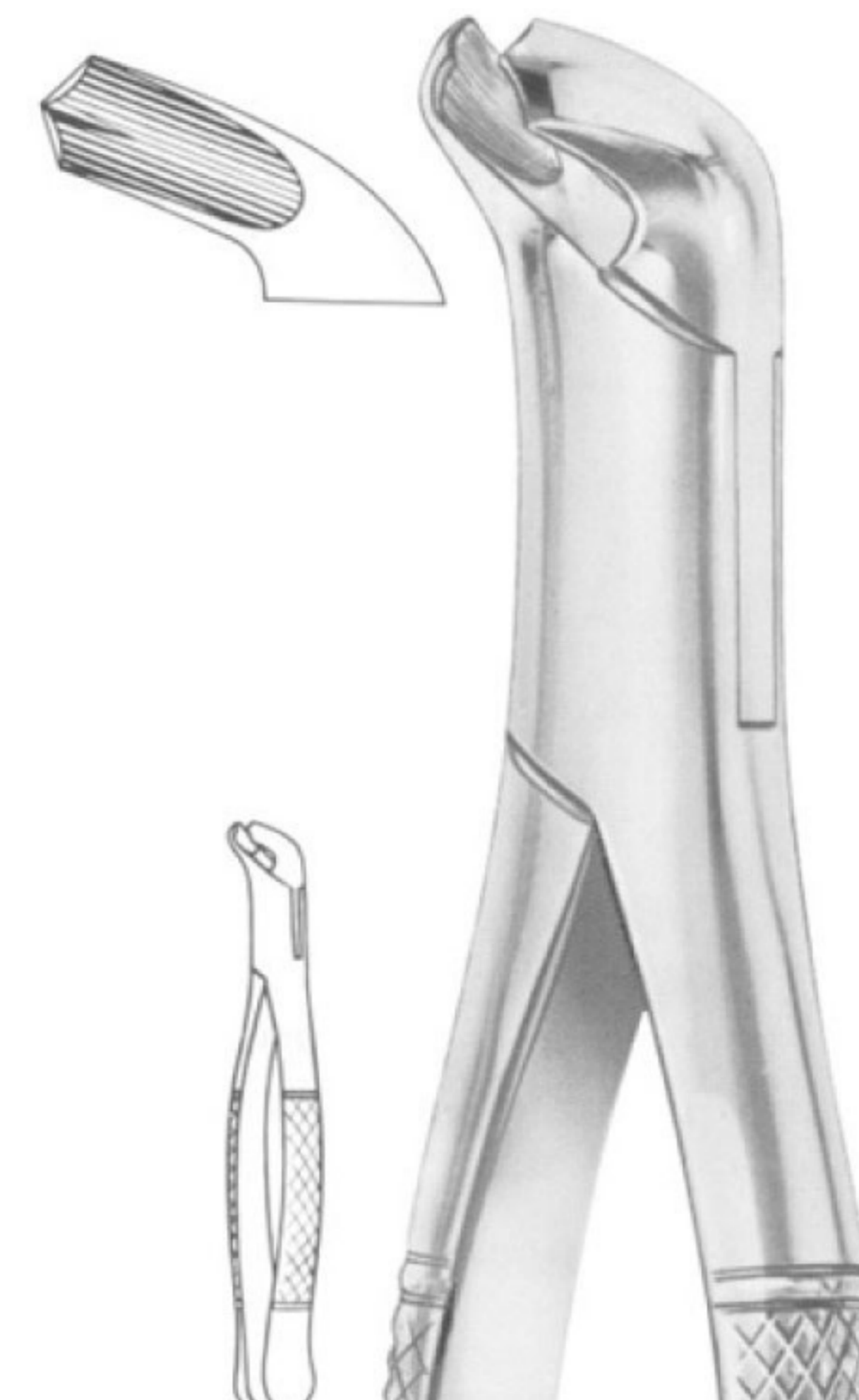

Fig. 17 lower molars
MWD-1239
 lower molars



Fig. 20R upper molars right
MWD-1240
 Fig. 20R upper molars right



Fig. 20L upper molars left
MWD-1241
 Fig. 20L upper molars left



Fig. 23 lower molars
MWD-1242
 Fig. 23 lower molars

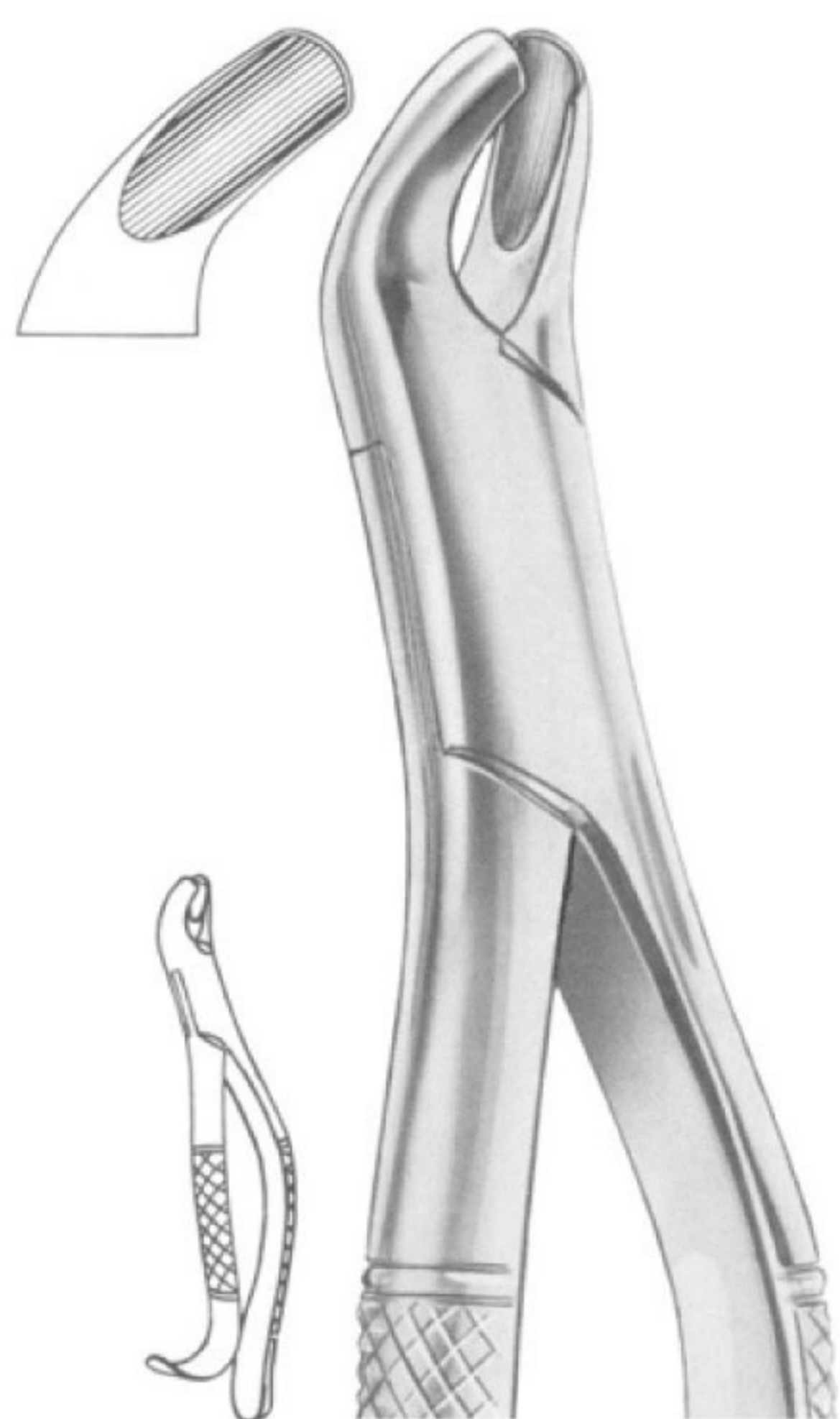

Fig. 24 upper molars
MWD-1243
Fig. 24 upper molars

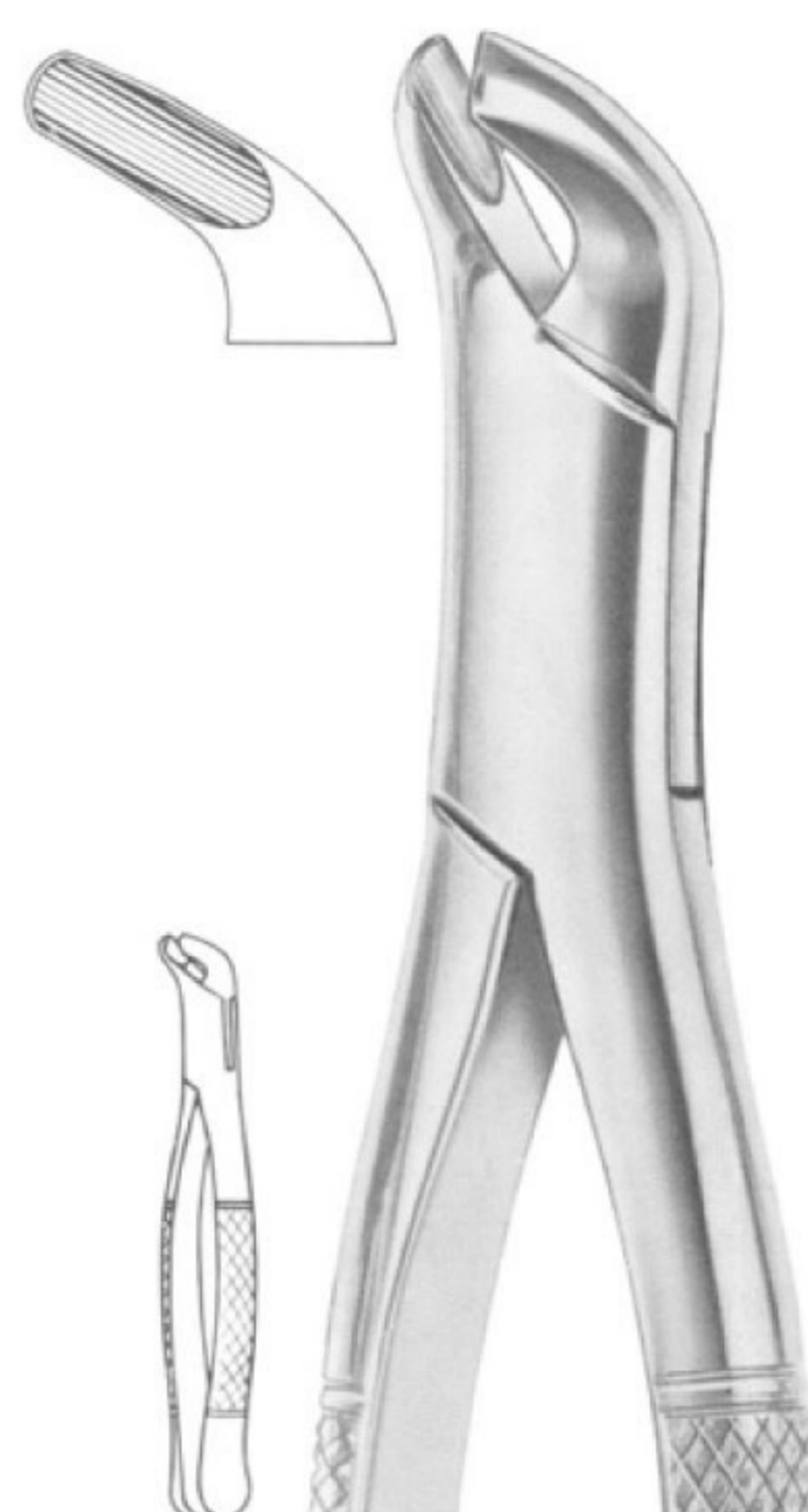

Fig. 27 lower molars
MWD-1244
Fig. 27 lower molars



Fig. 29S lower teeth for children
MWD-1245
Fig. 29S lower teeth for children



Fig. 30S upper teeth for children
MWD-1246
Fig. 30S upper teeth for children



PARMLY Fig. 32 upper premolars and molars
MWD-1247
PARMLY Fig. 32 upper premolars and molars

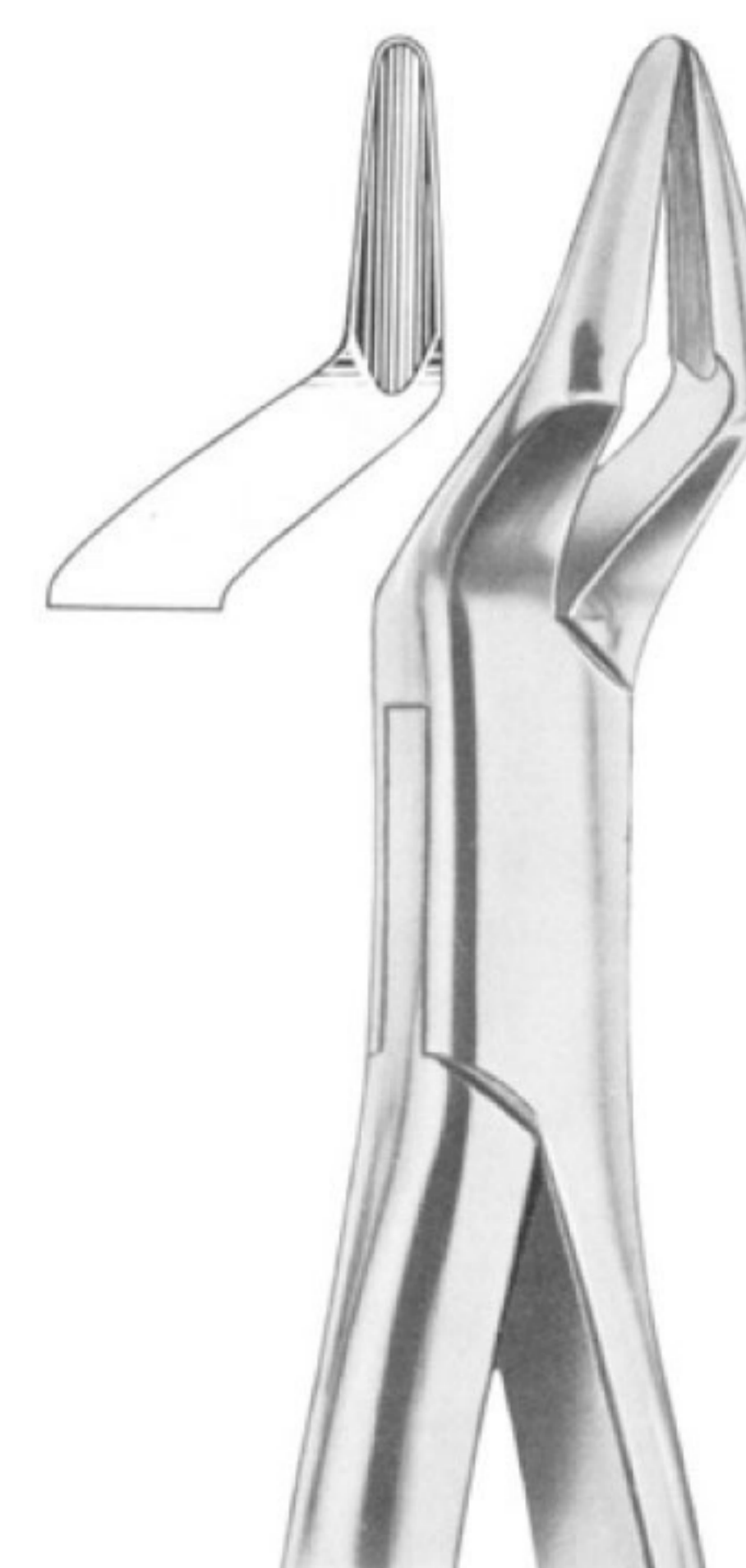

PARMLY Fig. 32A upper premolars and roots
MWD-1248
PARMLY Fig. 32A upper premolars and roots



Fig. 34 lower anteriors and roots
MWD-1249
 Fig. 34 lower anteriors and roots

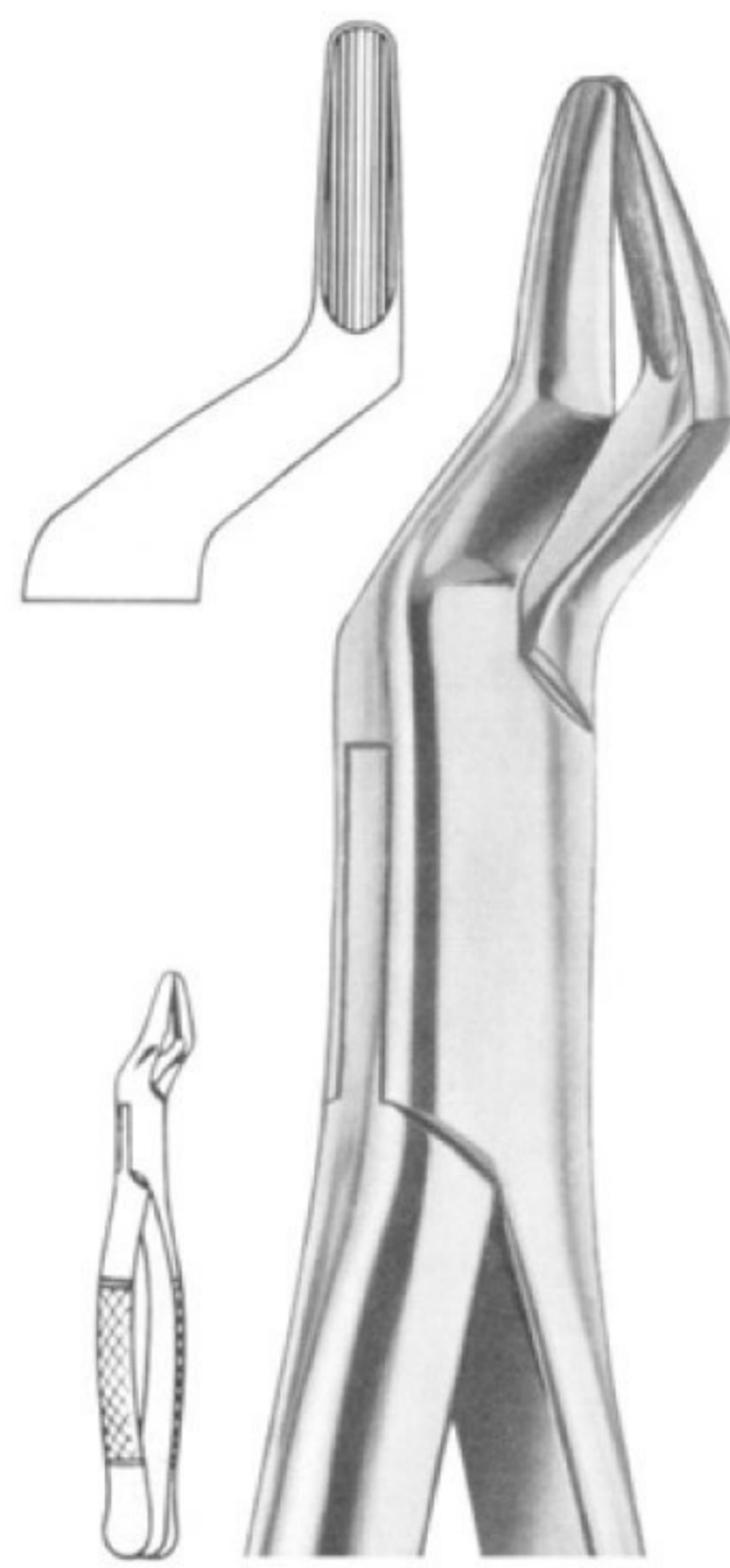

Fig. 35 upper roots
MWD-1250
 Fig. 35 upper roots

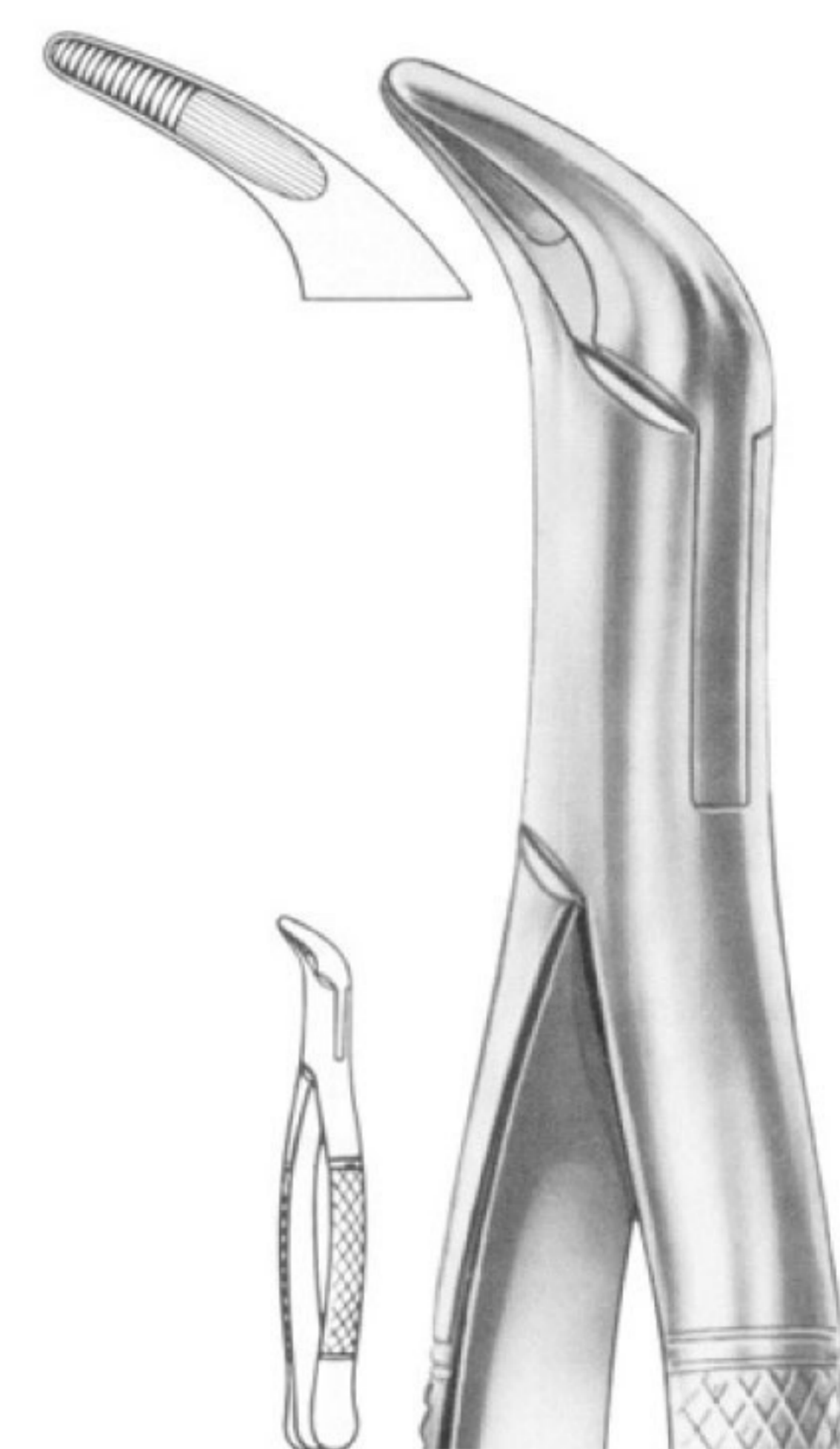

Fig. 36 lower anteriors and roots
MWD-1251
 Fig. 36 lower anteriors and roots



Fig. 37 lower anteriors and roots
MWD-1252
 Fig. 37 lower anteriors and roots

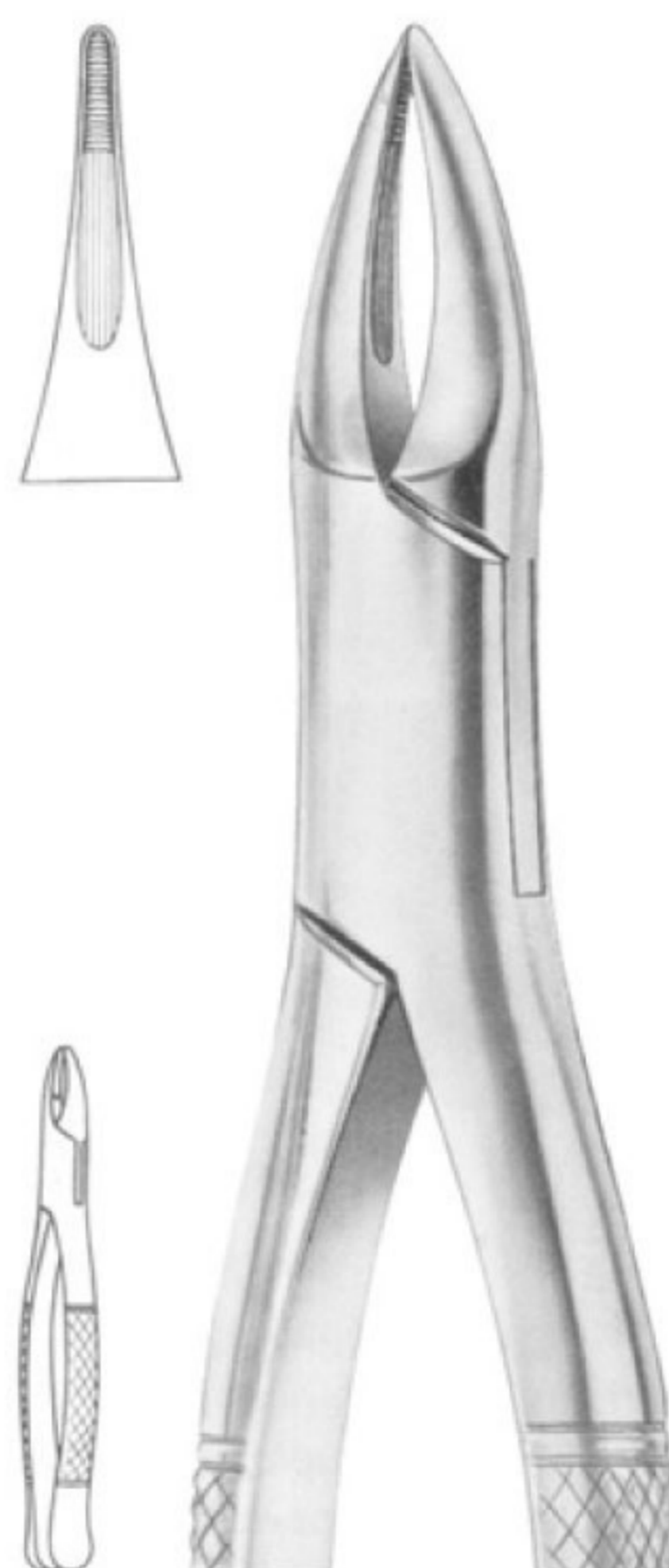

Fig. 38 upper anteriors and roots
MWD-1253
 Fig. 38 upper anteriors and roots



Fig. 53R upper molars right
MWD-1254
 Fig. 53R upper molars right



**Fig. 53L upper molars left
MWD-1255**
Fig. 53L upper molars left



**Fig. 62 incisors, premolars, deciduous
teeth
MWD-1256**
Fig. 62 incisors, premolars, deciduous teeth



**Fig. 65 upper incisors and roots
MWD-1257**
Fig. 65 upper incisors and roots



**TOMES Fig. 69 upper and lower roots
MWD-1258**
TOMES Fig. 69 upper and lower roots



**TOMES Fig. 85 lower canines, premolars
and molars
MWD-1259**
TOMES Fig. 85 lower canines, premolars
and molars

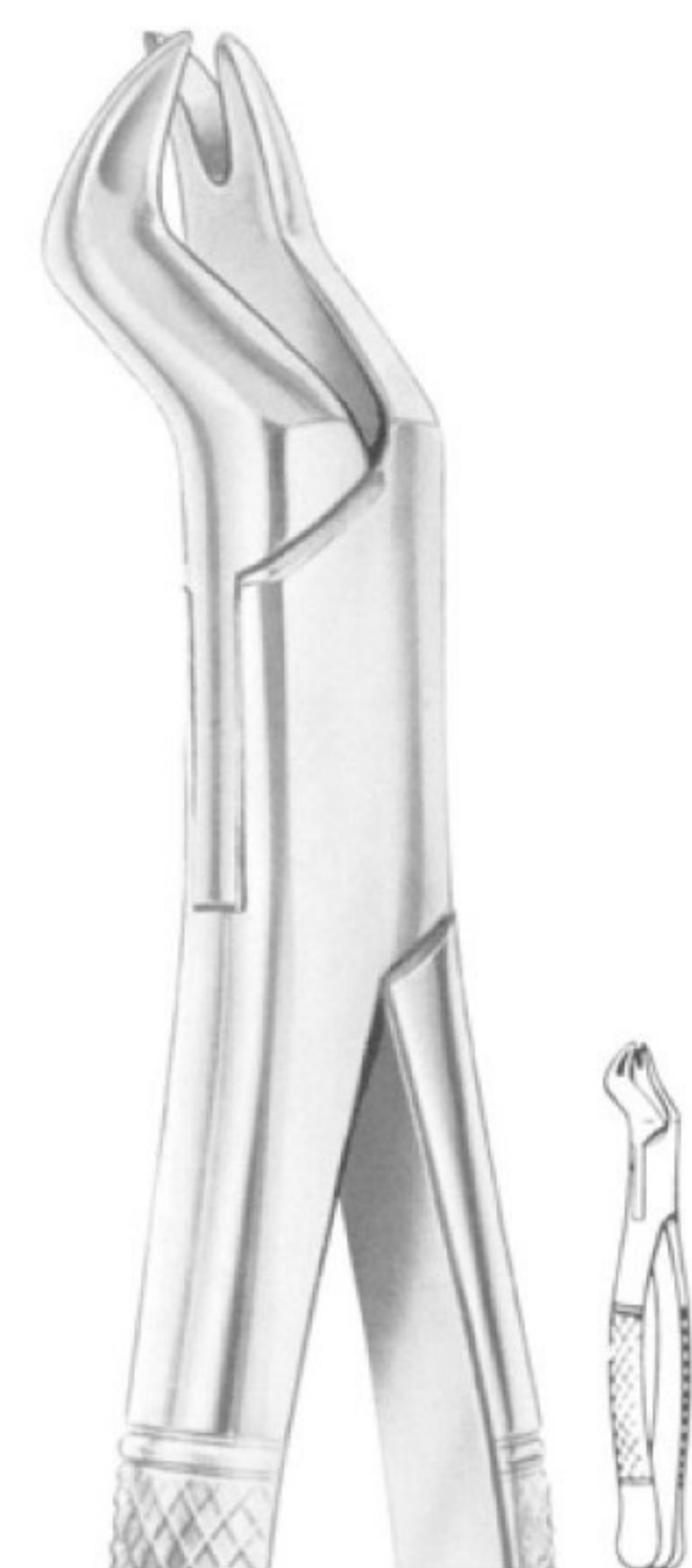

**NEVIUS Fig. 88R upper molars right
MWD-1260**
NEVIUS Fig. 88R upper molars right

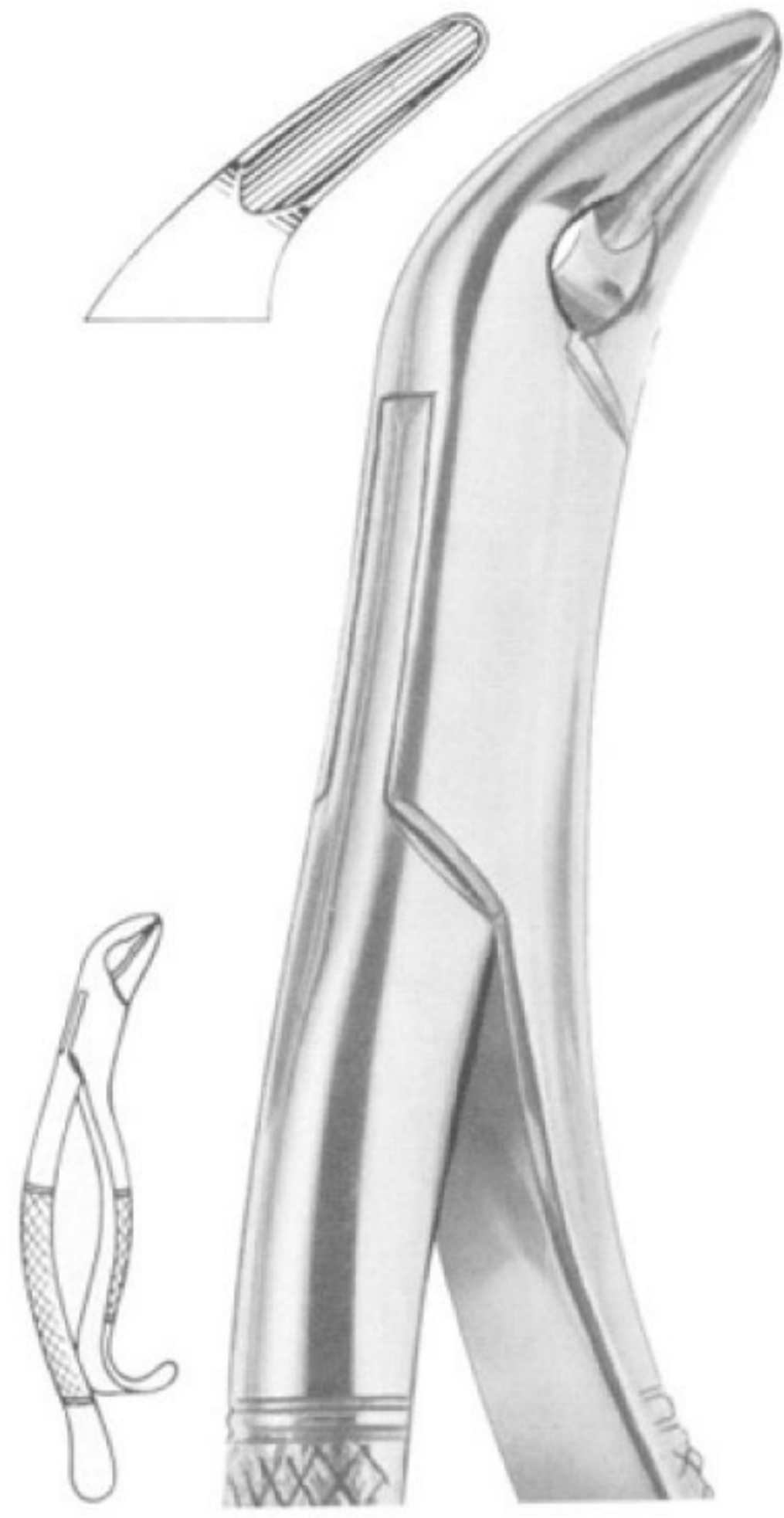

**THOMAS Fig. 85A lower canines,
premolars and molars
MWD-1261**

THOMAS Fig. 85A lower canines, premolars
and molars



**NEVIUS Fig. 88L upper molars left
MWD-1262**

NEVIUS Fig. 88L upper molars left



**KELLS Fig. 99A upper incisors, canines,
premolars
MWD-1263**

KELLS Fig. 99A upper incisors, canines,
premolars



**Fig. 104 upper third molars
MWD-1264**

Fig. 104 upper third molars

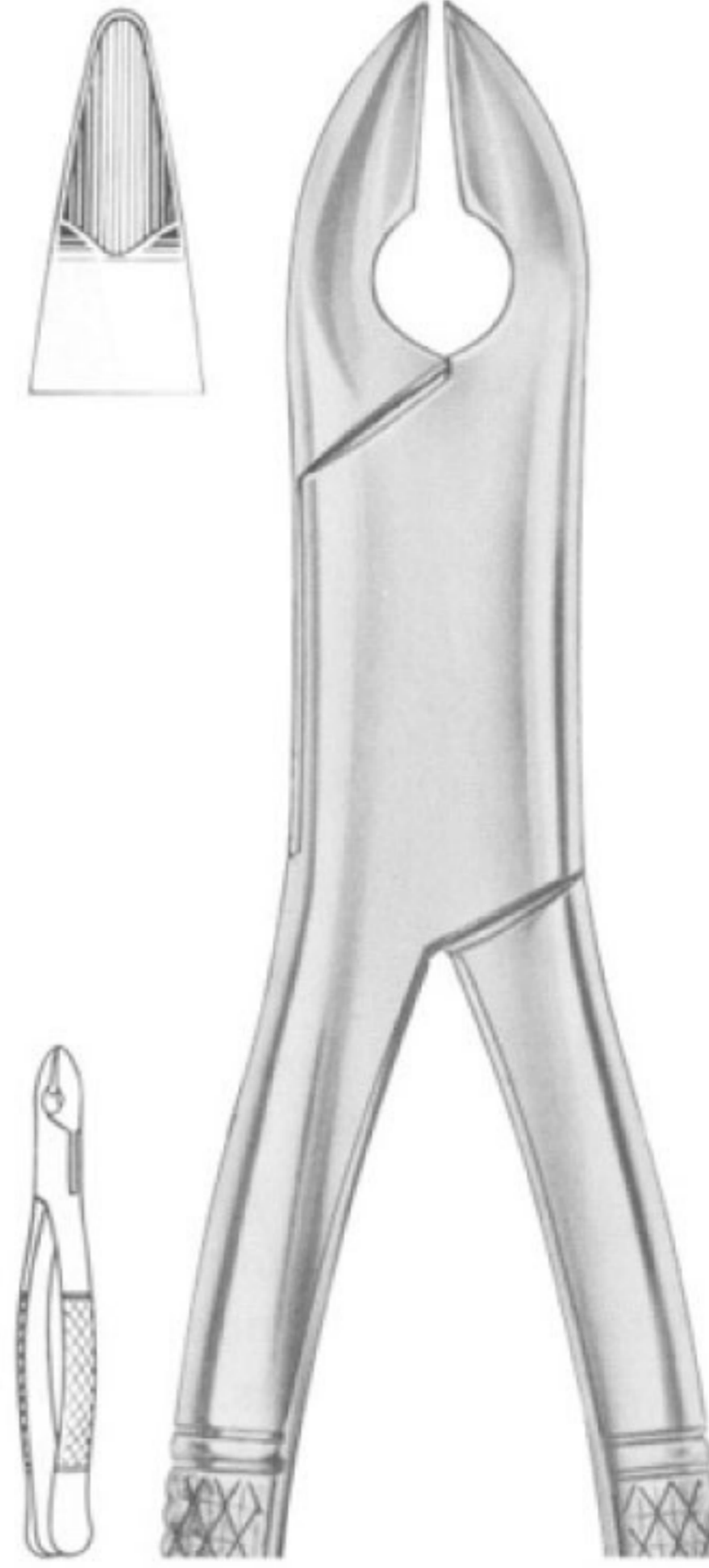

**KELLS Fig. 99C upper incisors, canines,
premolars
MWD-1265**

KELLS Fig. 99C upper incisors, canines,
premolars



**HULL Fig. 101 deciduous teeth
MWD-1266**

HULL Fig. 101 deciduous teeth



Fig. 103 lower incisors, premolars
MWD-1267

Fig. 103 lower incisors, premolars



CRYER Fig. 150 lower incisors, premolars, roots
MWD-1268

CRYER Fig. 150 lower incisors, premolars, roots



CRYER Fig. 150A upper incisors, premolars, roots
MWD-1269

CRYER Fig. 150A upper incisors, premolars, roots

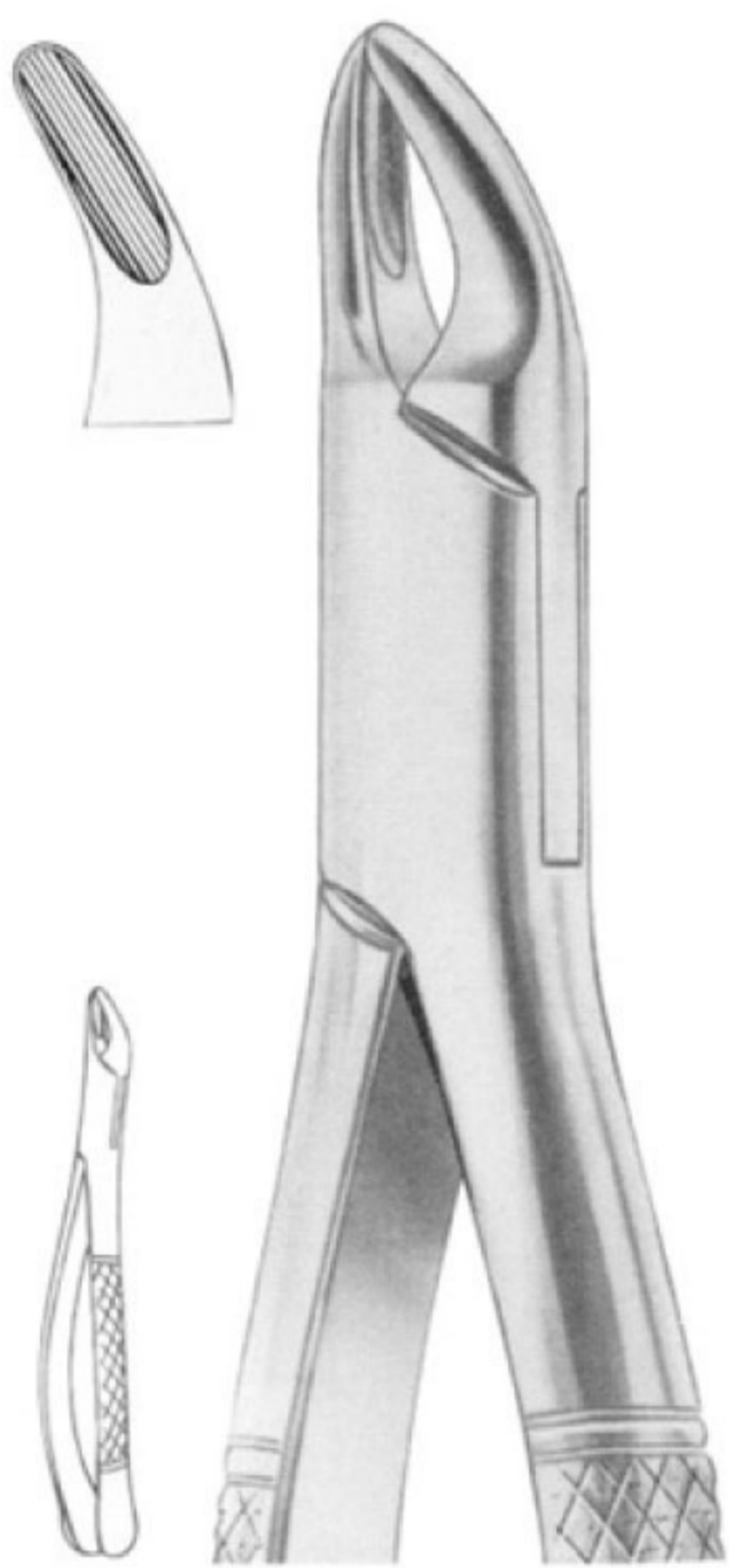

CRYER Fig. 150S upper teeth for children
MWD-1270

CRYER Fig. 150S upper teeth for children



CRYER Fig. 151 lower incisors, premolars, roots
MWD-1271

CRYER Fig. 151 lower incisors, premolars, roots

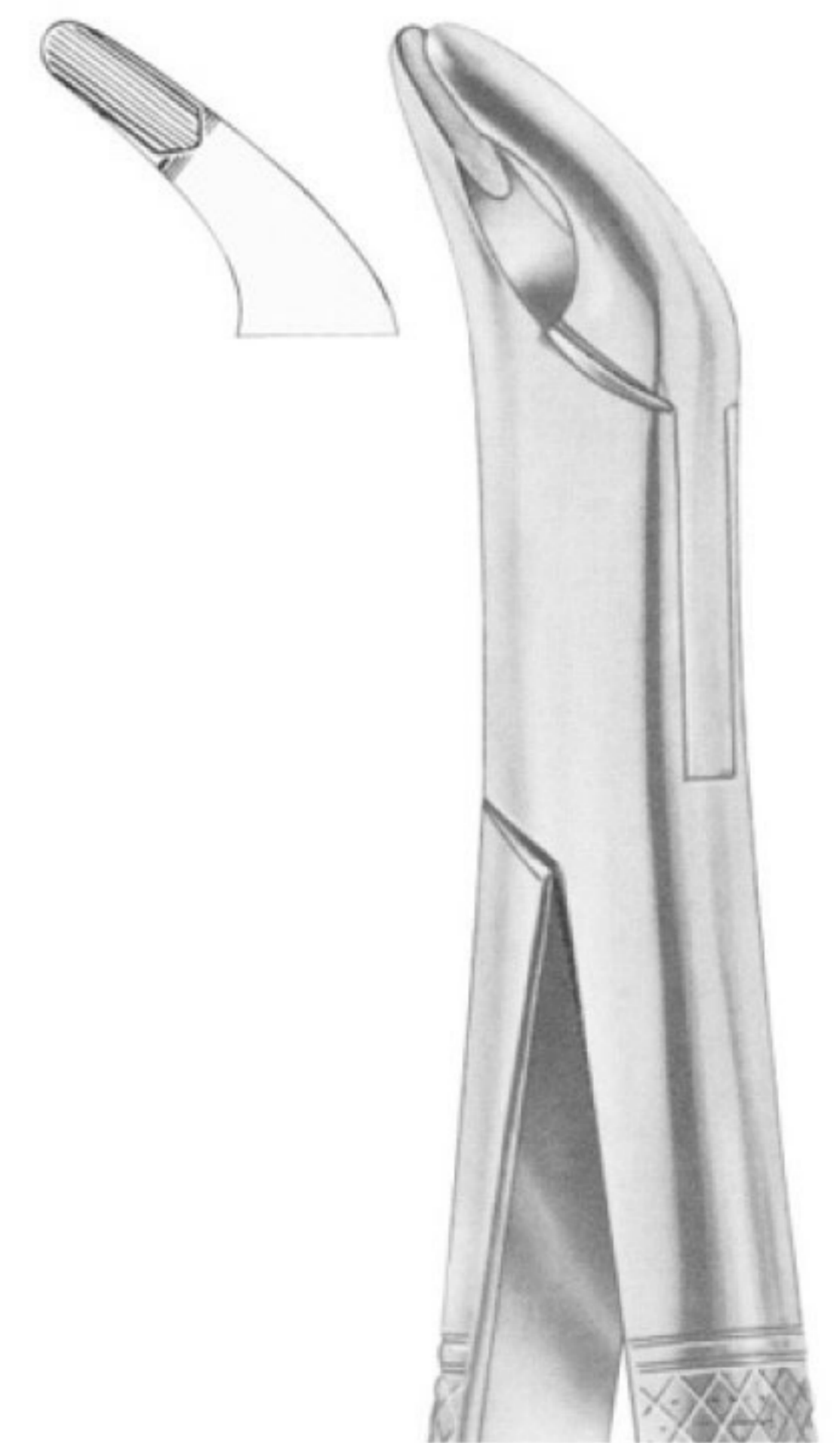

CRYER Fig. 151A lower incisors, premolars, roots
MWD-1272

CRYER Fig. 151A lower incisors, premolars, roots

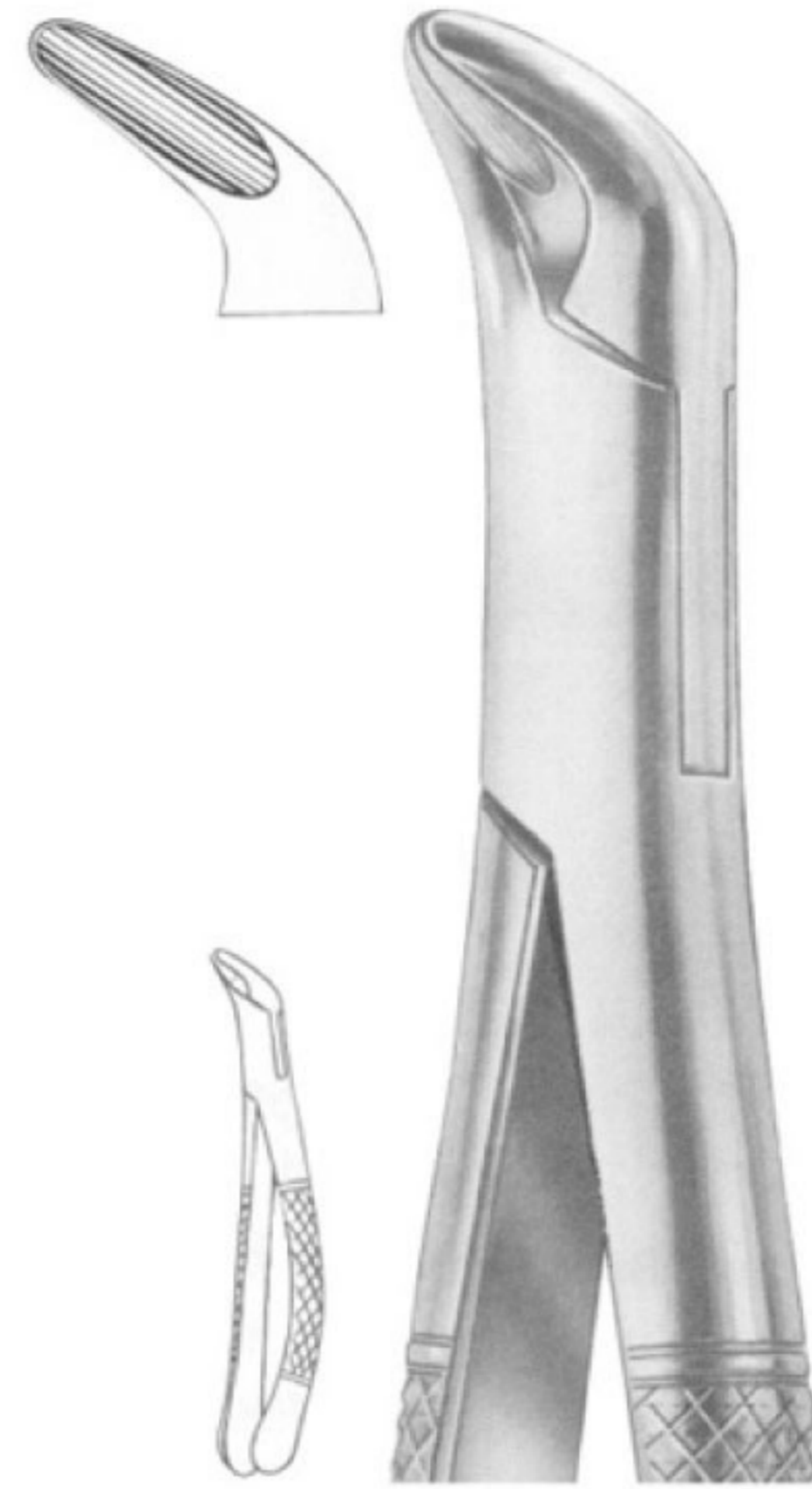

CRYER Fig. 151S lower teeth for children

MWD-1273

CRYER Fig. 151S lower teeth for children



DEL 78
MWD-1298
DEL 78

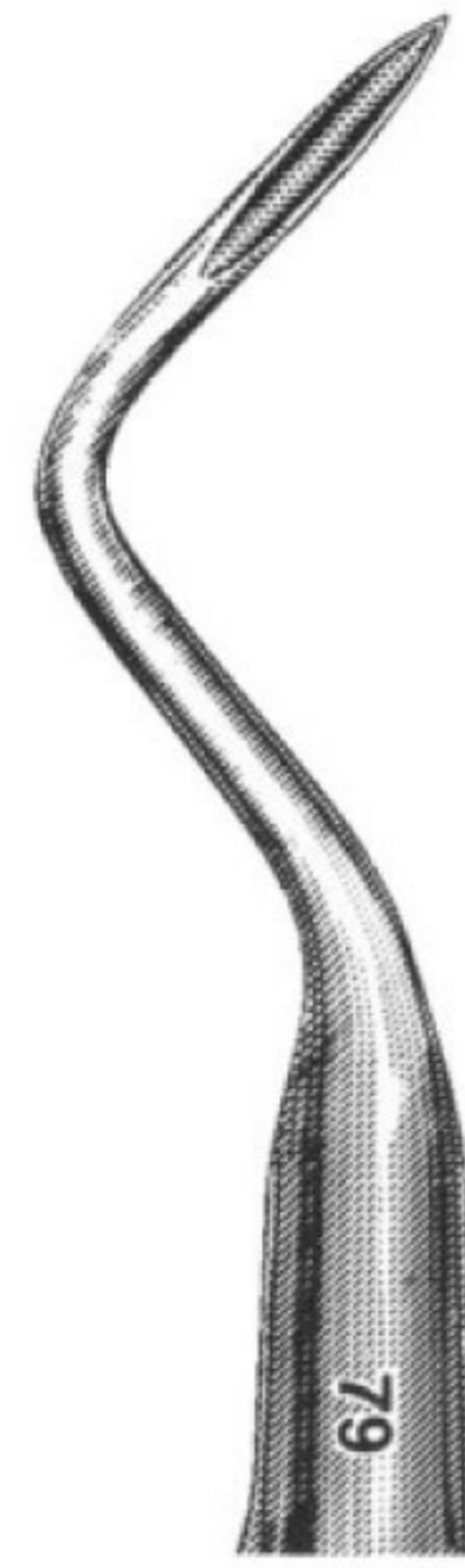

DEL 79
MWD-1299
DEL 79

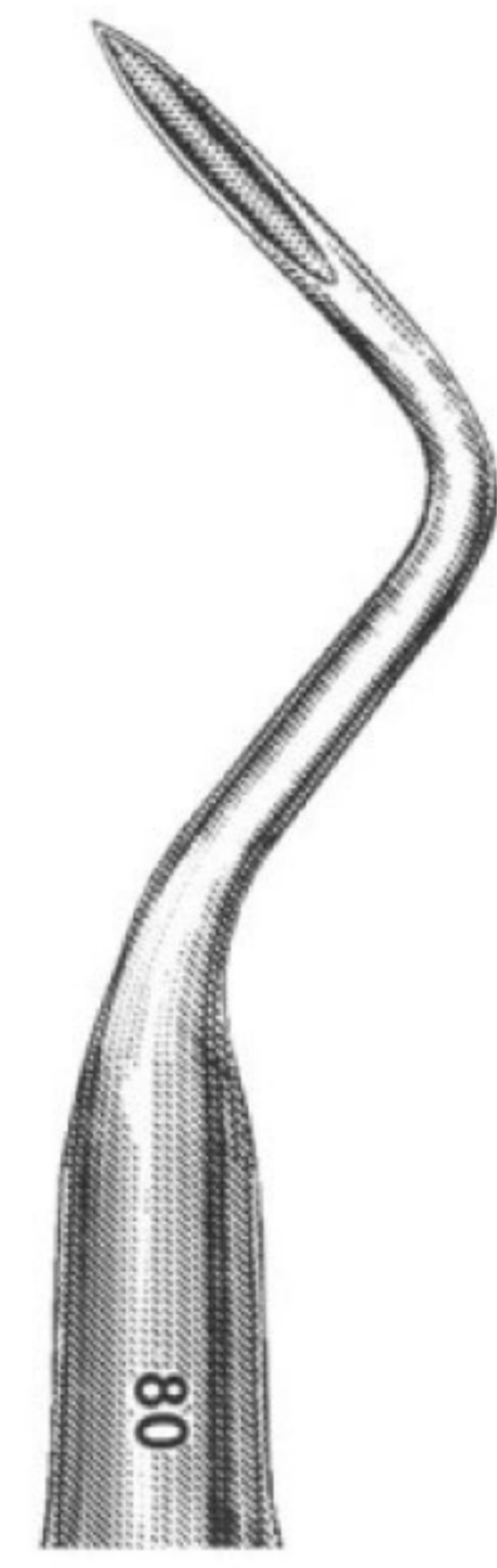

DEL 80
MWD-1300
DEL 80



DEL H1
MWD-1301
DEL H1



DEL H2
MWD-1302
DEL H2



DEL H3
MWD-1303
DEL H3



DEL H2-3
MWD-1304
 DEL H2-3



POTT 6X
MWD-1305
 POTT 6X



POTT 7X
MWD-1306
 POTT 7X



FREER
MWD-1307
 FREER



WEST DEL W2
MWD-1308
 WEST DEL W2



DEL OHL
MWD-1309
 DEL OHL

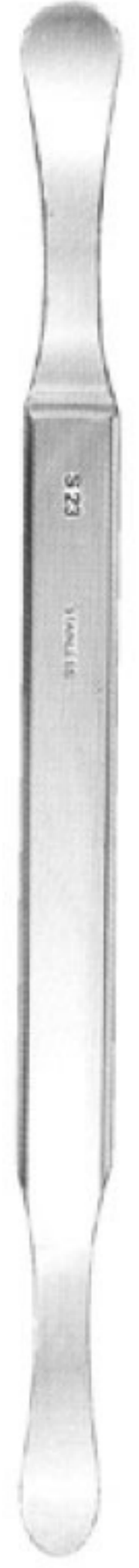

SELDIN
MWD-1310
SELDIN



MOLT
MWD-1311
MOLT



MWD-1312



MWD-1313



BEIN
MWD-1314
BEIN

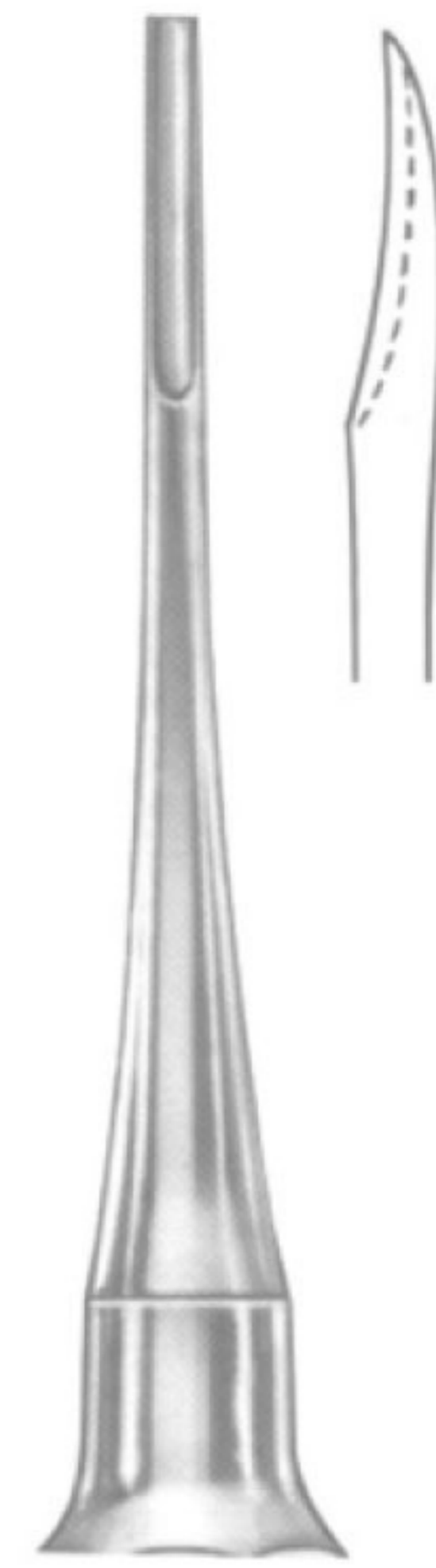

BEIN Fig. 1
MWD-1315
BEIN Fig. 1

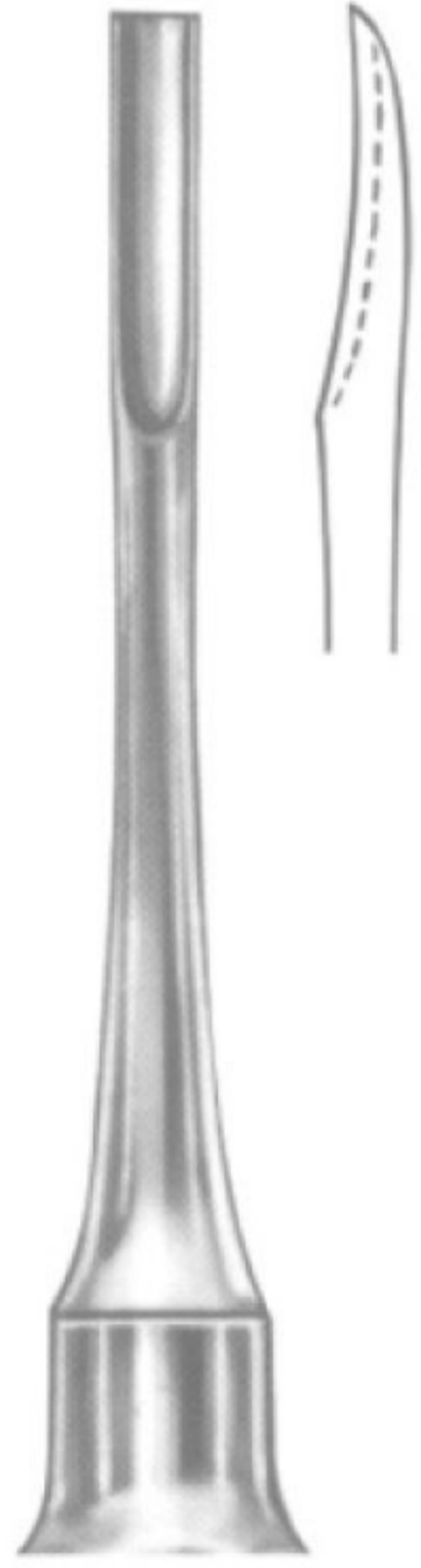

BEIN Fig. 2
MWD-1316
BEIN Fig. 2

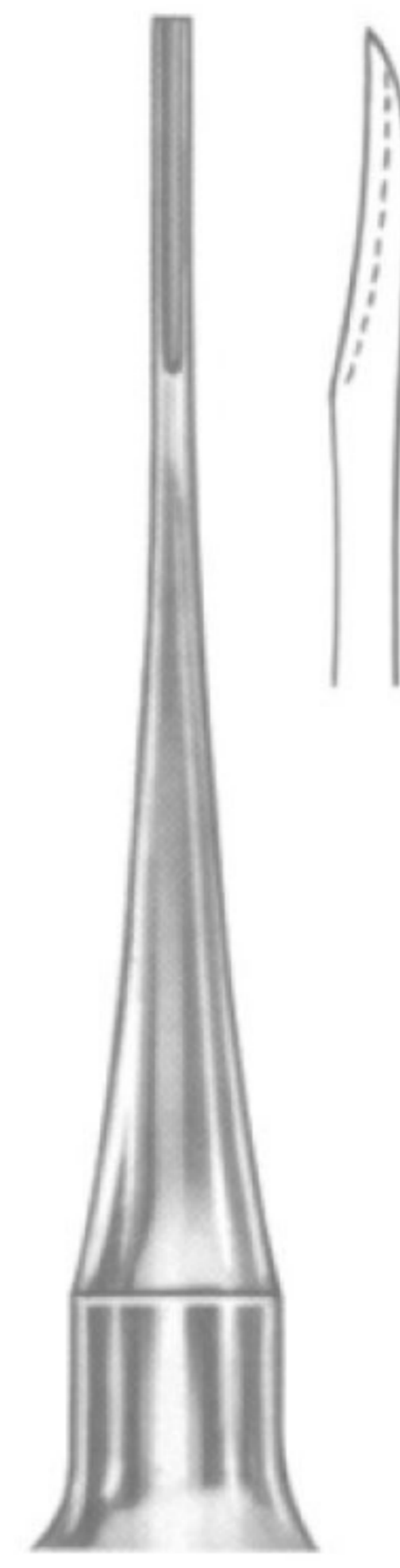

BEIN Fig. 0
MWD-1317
BEIN Fig. 0



BEIN Fig. 3
MWD-1318
BEIN Fig. 3

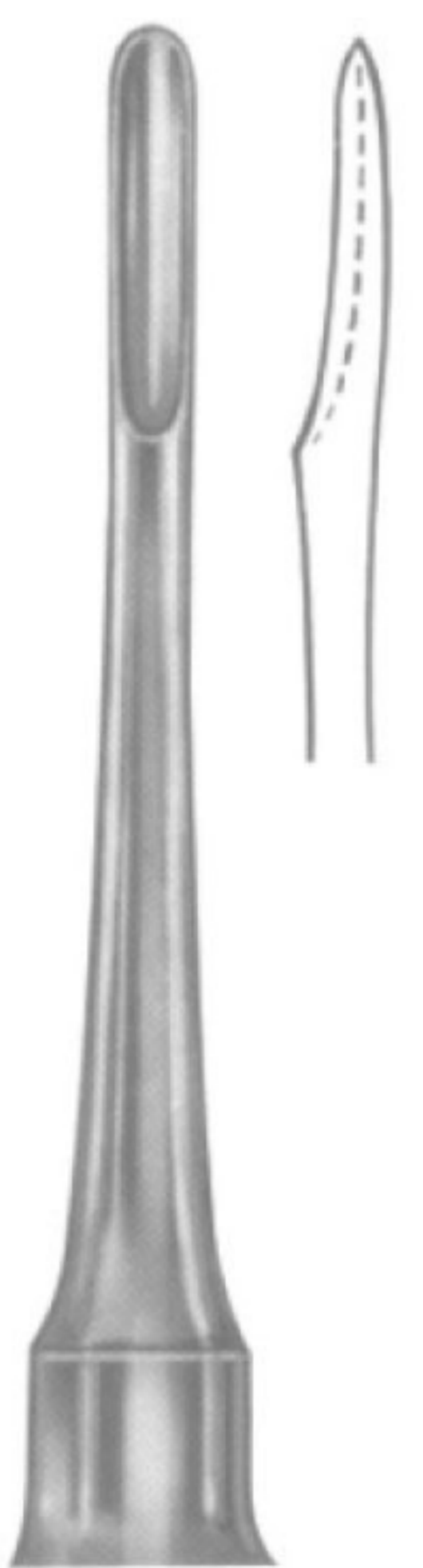

BEIN Fig. 4
MWD-1319
BEIN Fig. 4

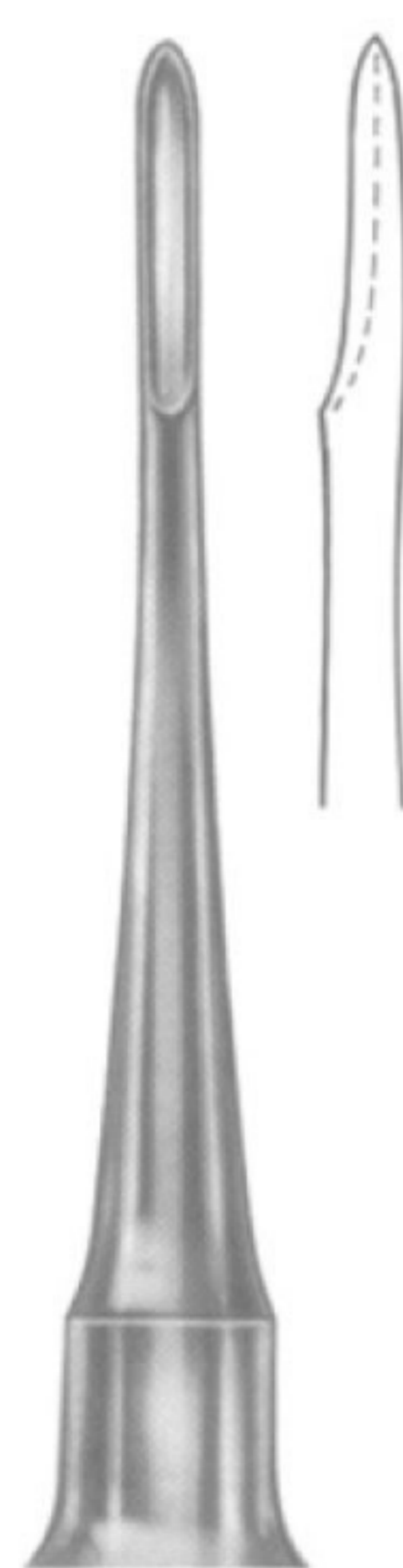

BEIN Fig. 5
MWD-1320
BEIN Fig. 5

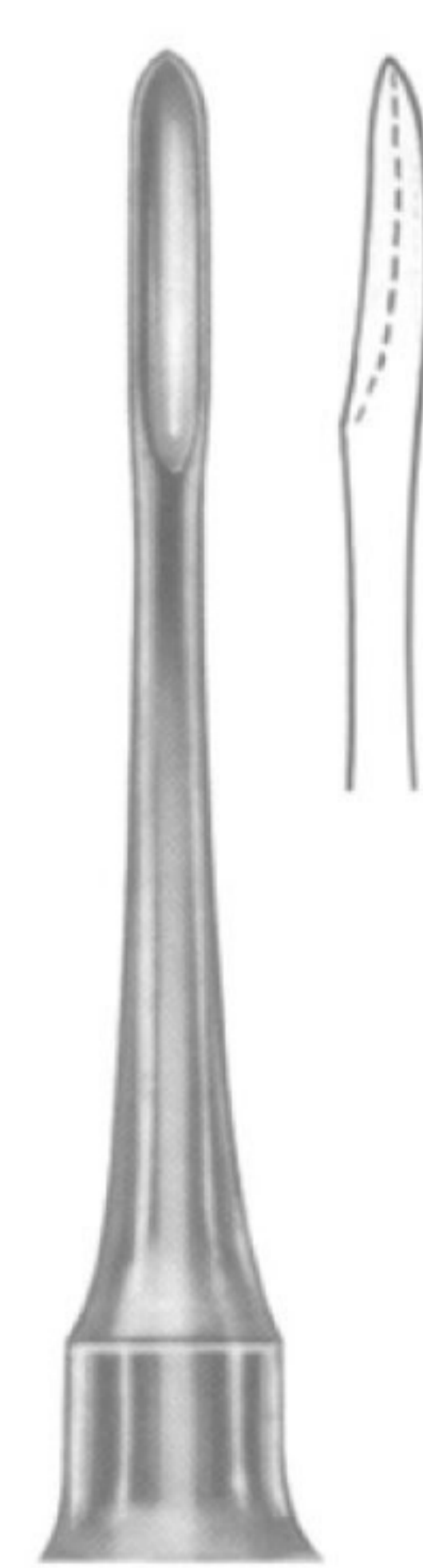

BEIN Fig. 6
MWD-1321
BEIN Fig. 6



SELDIN
MWD-1322
SELDIN



SELDIN Fig. 1L
MWD-1323
SELDIN Fig. 1L



SELDIN Fig. 1R
MWD-1324
SELDIN Fig. 1R



SELDIN Fig. 2
MWD-1325
SELDIN Fig. 2



SELDIN Fig. 3
MWD-1326
SELDIN Fig. 3



SELDIN Fig. 4L
MWD-1327
SELDIN Fig. 4L



SELDIN Fig. 4R
MWD-1328
 SELDIN Fig. 4R



CRYER Fig. 3
MWD-1329
 CRYER Fig. 3



CRYER Fig. 4
MWD-1330
 CRYER Fig. 4



CRYER Fig. 12
MWD-1331
 CRYER Fig. 12



CRYER Fig. 27
MWD-1332
 CRYER Fig. 27



CRYER Fig. 28
MWD-1333
 CRYER Fig. 28



CRYER Fig. 27S
MWD-1334
 CRYER Fig. 27S



IS-APICAL
MWD-1336
 IS-APICAL



APICAL Fig. 1
MWD-1337
 APICAL Fig. 1



APICAL Fig. 2
MWD-1338
 APICAL Fig. 2



APICAL Fig. 3
MWD-1339
 APICAL Fig. 3



APICAL Fig. 4
MWD-1340
 APICAL Fig. 4



IS-CRYER
MWD-1341
 IS-CRYER



CRYER Fig. 1
MWD-1342
 CRYER Fig. 1



CRYER Fig. 2
MWD-1343
 CRYER Fig. 2

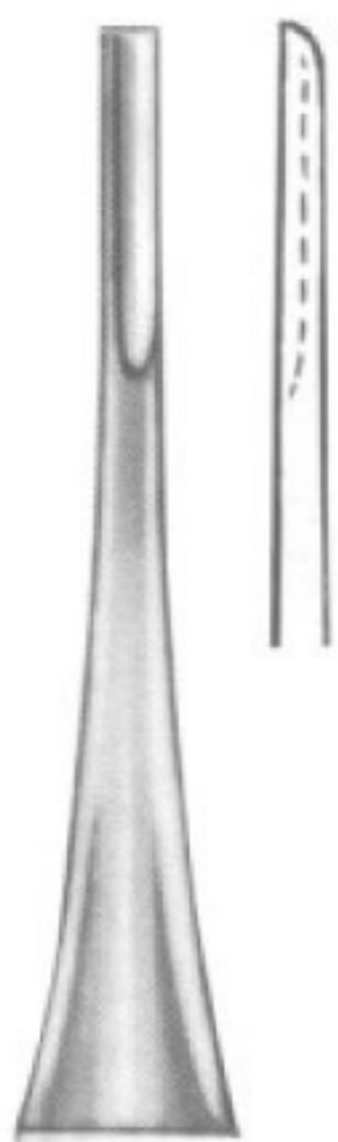

COUPLAND Fig. 1
MWD-1345
 COUPLAND Fig. 1

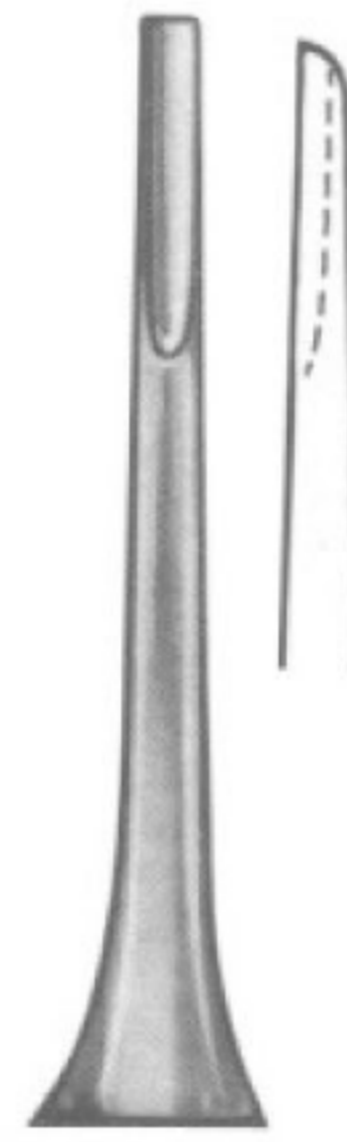

COUPLAND Fig. 2
MWD-1346
 COUPLAND Fig. 2

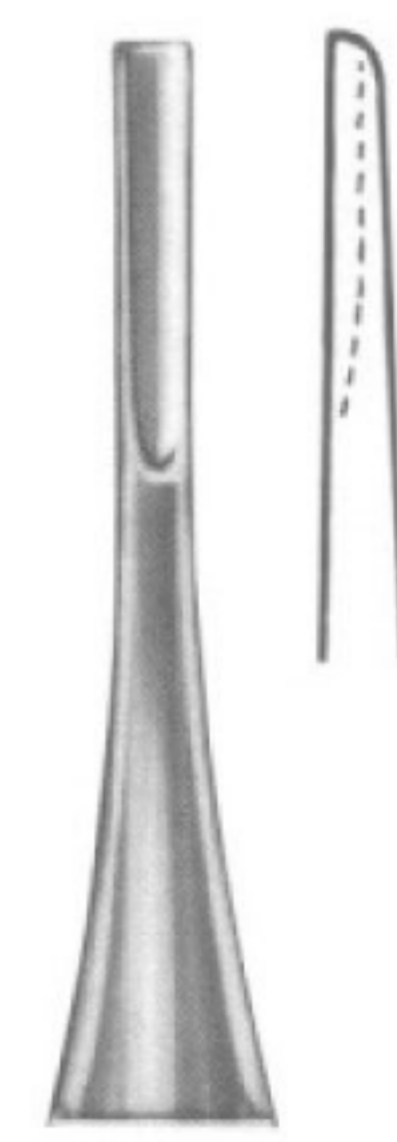

COUPLAND Fig. 3
MWD-1347
 COUPLAND Fig. 3



Fig. 1
MWD-1348
Fig. 1

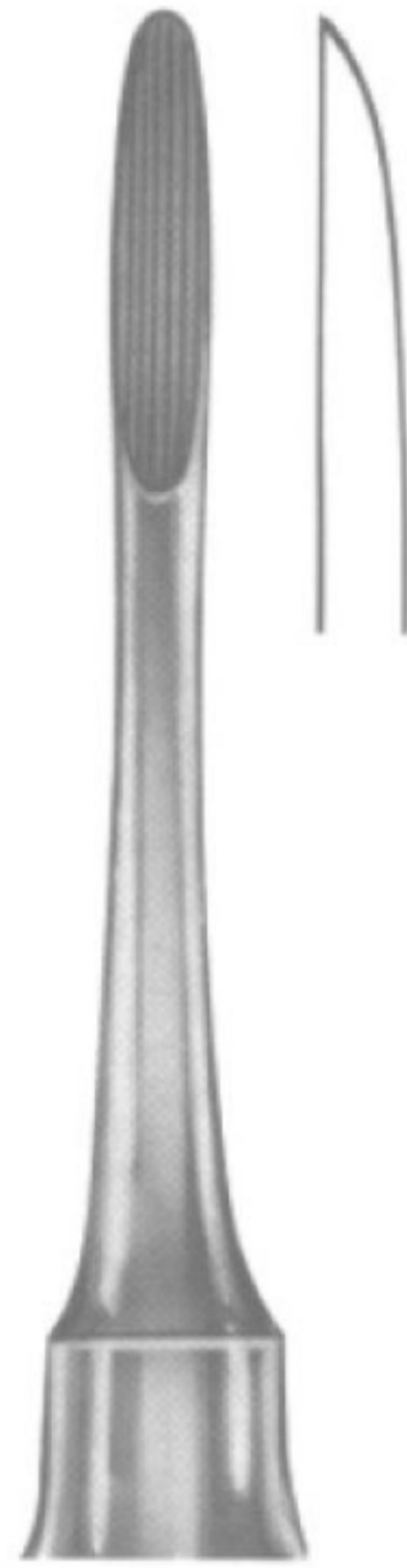

Fig. 3
MWD-1350
Fig. 3



FLOHR Fig. 1
MWD-1351
FLOHR Fig. 1



FLOHR Fig. 2
MWD-1352
FLOHR Fig. 2



FLOHR Fig. 3
MWD-1353
FLOHR Fig. 3



KOPP
MWD-1354
KOPP



KOPP Fig. 1
MWD_1354
KOPP Fig. 1



KOPP Fig. 2
MWD-1355
KOPP Fig. 2



KOPP Fig. 3
MWD-1356
KOPP Fig. 3



KOPP Fig. 4
MWD-1357
KOPP Fig. 4



KOPP Fig. 5
MWD-1358
KOPP Fig. 5



KOPP Fig. 6
MWD-1359
KOPP Fig. 6



KOPP Fig. 1
MWD-1360
 KOPP Fig. 1



KOPP Fig. 2
MWD-1361
 KOPP Fig. 2



KOPP Fig. 3
MWD-1362
 KOPP Fig. 3



KOPP Fig. 4
MWD-1363
 KOPP Fig. 4



HYLIN
MWD-1364
 HYLIN

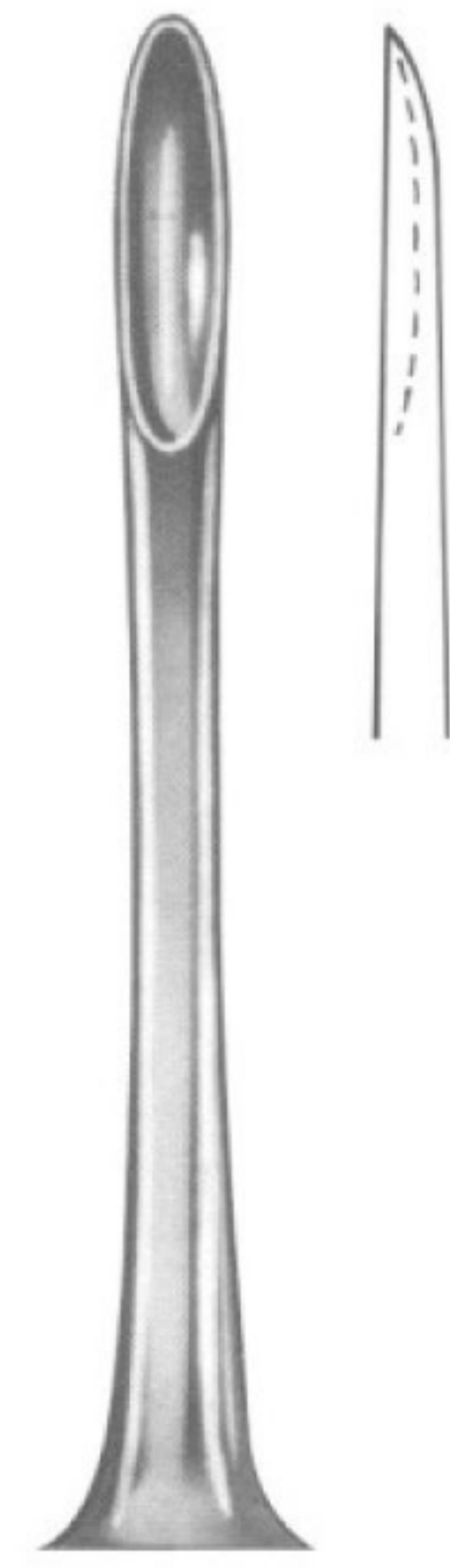

HYLIN Fig. 1
MWD-1364-1
 HYLIN Fig. 1

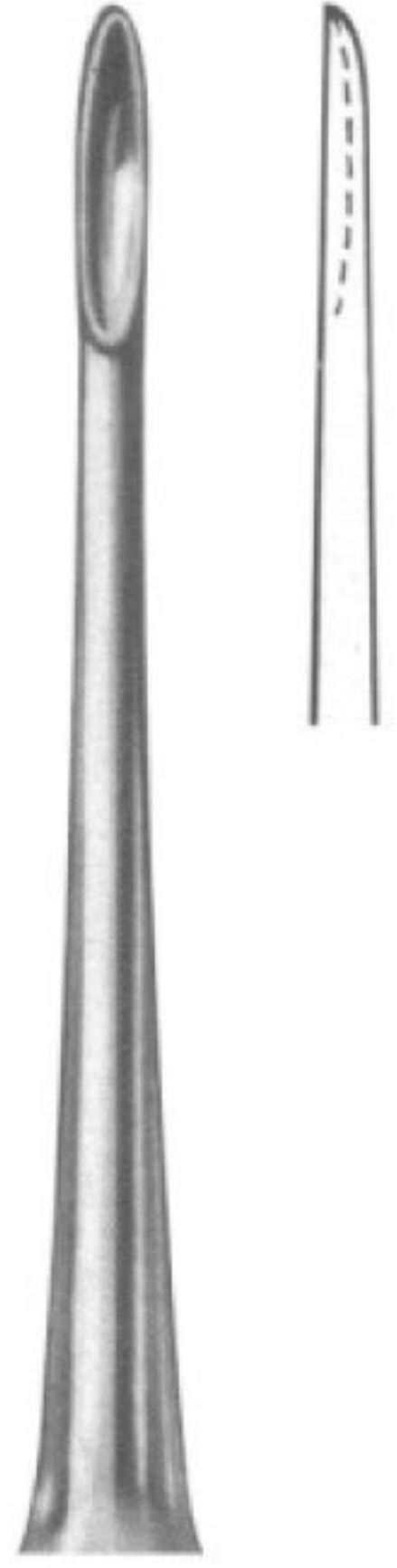

HYLIN Fig. 2
MWD-1365
 HYLIN Fig. 2



BEIN
MWD-1366
 BEIN

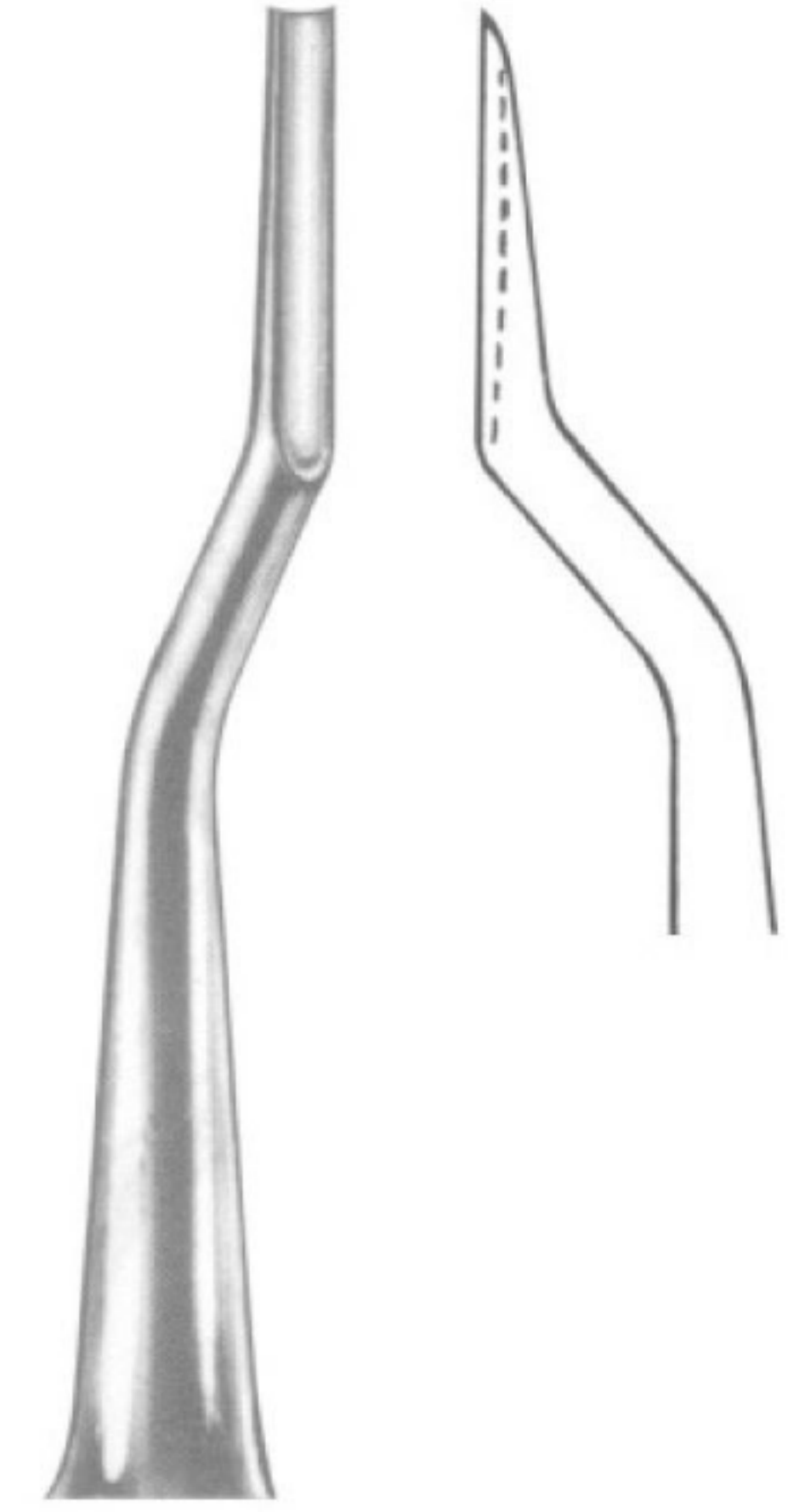

BEIN Fig. 1
MWD-1366-1
 BEIN Fig. 1

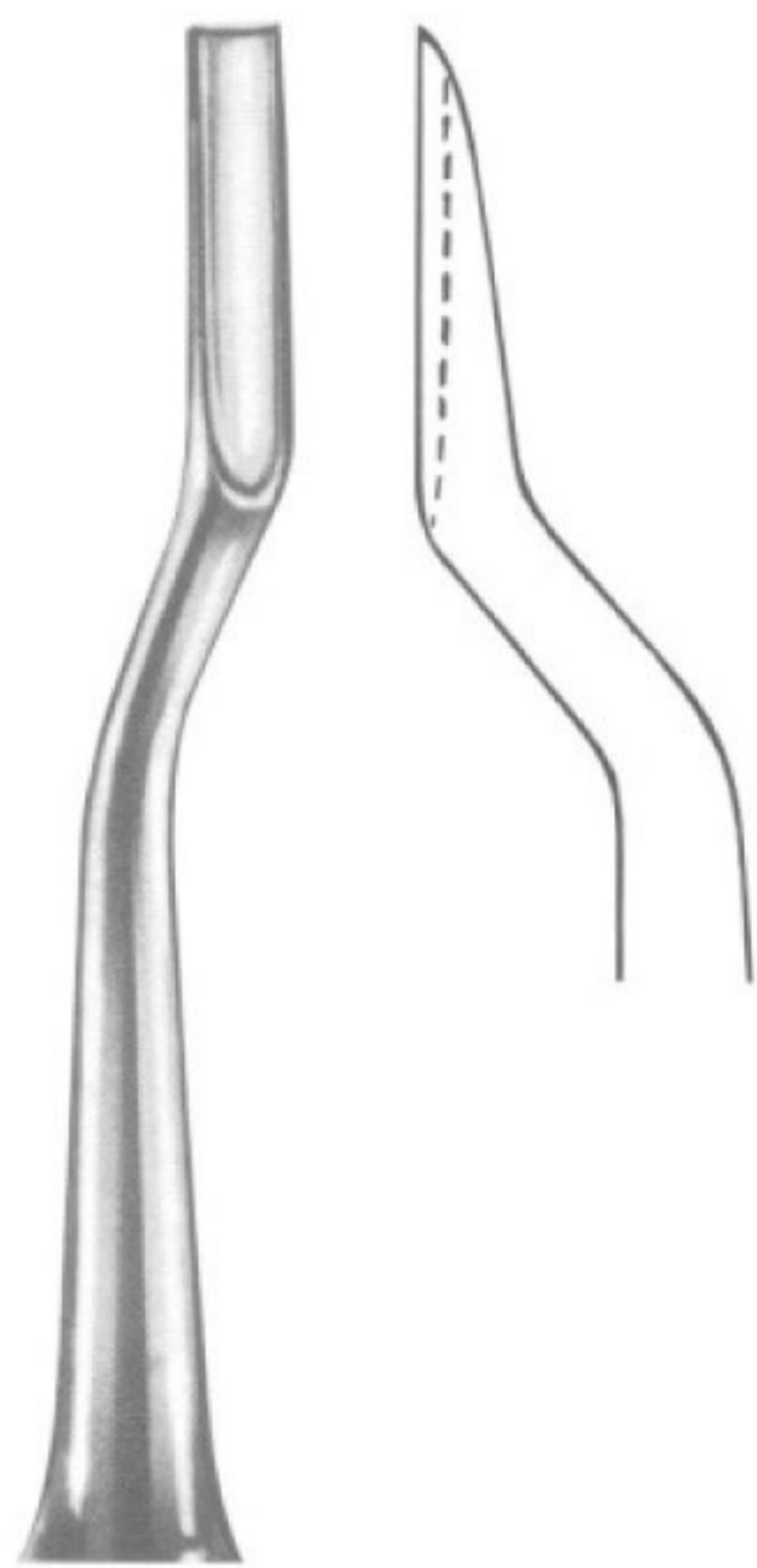

BEIN Fig. 2
MWD-1367
 BEIN Fig. 2



BEIN Fig. 3
MWD-1368
 BEIN Fig. 3

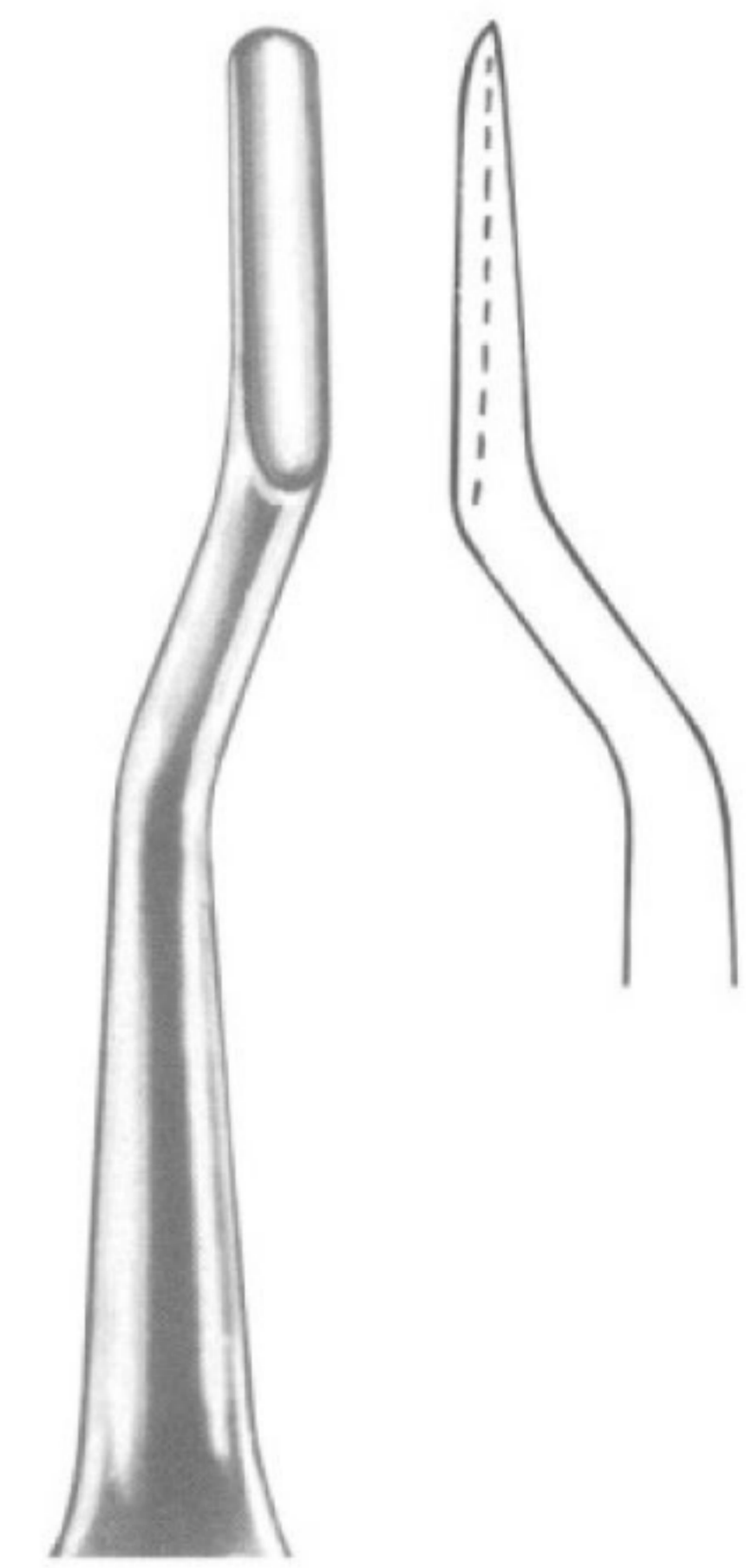

BEIN Fig. 4
MWD-1369
 BEIN Fig. 4



WARWICK-JAMES Fig. 1
MWD-1370
 WARWICK-JAMES Fig. 1



Warwick-James Fig. 2
MWD-1371
 Warwick-James Fig. 2



Warwick-James Fig. 3
MWD-1372
 Warwick-James Fig. 3



London-Hospital Fig. 1
MWD-1373
 London-Hospital Fig. 1



London-Hospital Fig. 2
MWD-1374
 London-Hospital Fig. 2

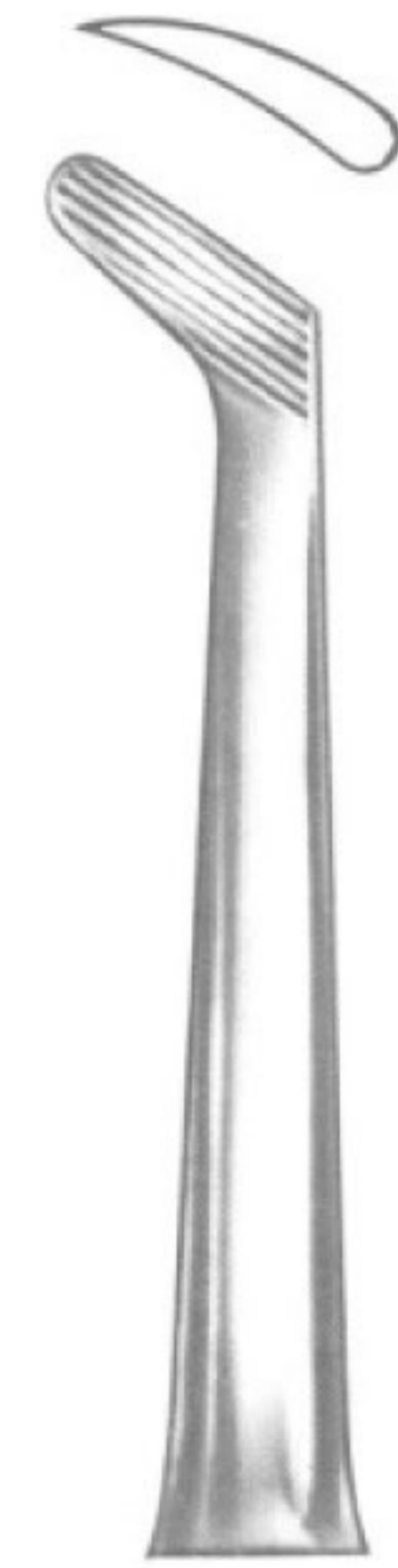

London-Hospital Fig. 3
MWD-1375
 London-Hospital Fig. 3



OTT
MWD-1376
OTT



Fig. 1
MWD-1377
Fig. 1



Fig. 2
MWD-1378
Fig. 2



Fig. 1
MWD-1379
Fig. 1



Fig. 2
MWD-1380
Fig. 2



CHOMPRET Fig. 1
MWD-1381
CHOMPRET Fig. 1



CHOMPRET Fig. 2
MWD-1382
CHOMPRET Fig. 2



CHOMPRET Fig. 3
MWD-1383
CHOMPRET Fig. 3



CHOMPRET Fig. 4
MWD-1384
CHOMPRET Fig. 4



APICAL
MWD-1385
APICAL



IS-Fig. 1
MWD-1386
IS-Fig.



Fig. 2
MWD-1387
Fig. 2



Fig. 3
MWD-1388
Fig. 3



HEIDBRINK Fig. 1
MWD-1389
HEIDBRINK Fig. 1



HEIDBRINK Fig. 1
MWD-1390
HEIDBRINK Fig. 1



HEIDBRINK Fig. 2
MWD-1391
HEIDBRINK Fig. 2



HEIDBRINK Fig. 3
MWD-1392
HEIDBRINK Fig. 3



MEAD MD1
MWD-1393
MEAD MD1



MEAD MD-5 A
MWD-1394
 MEAD MD-5 A



MEAD MD-6 A
MWD-1395
 MEAD MD-6 A



MEAD MD-7 A
MWD-1396
 MEAD MD-7 A



MEAD MD-8
MWD-1397
 MEAD MD-8

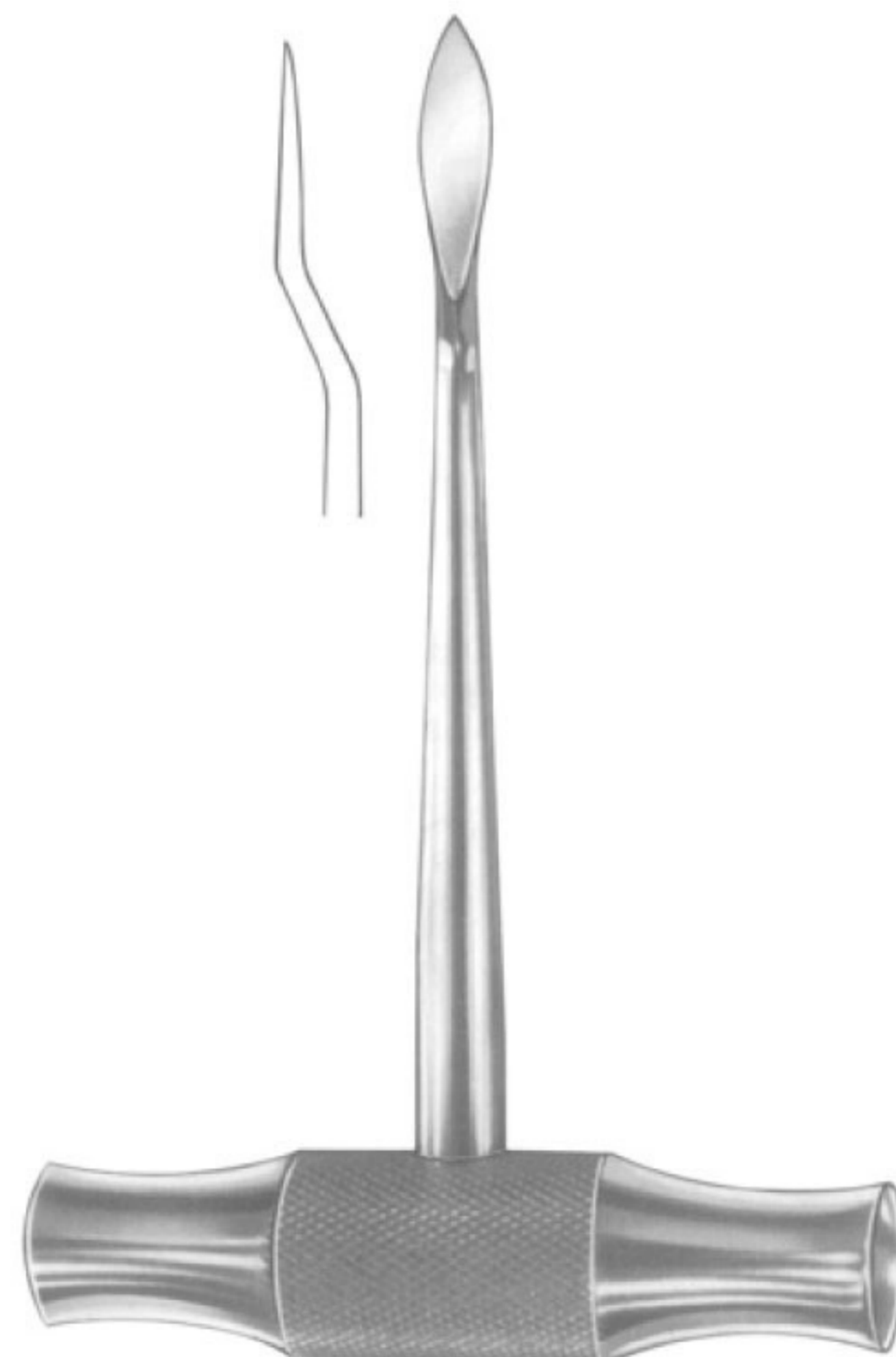

LECLUSE
MWD-1398
 LECLUSE



WINTER
MWD-1399
 WINTER



WINTER Fig. 1R
MWD-1400
WINTER Fig. 1R



WINTER Fig. 2L
MWD-1401
WINTER Fig. 2L



WINTER Fig. 2R
MWD-1402
WINTER Fig. 2R



WINTER Fig. 11L
MWD-1403
WINTER Fig. 11L



WINTER Fig. 11R
MWD-1404
WINTER Fig. 11R



WINTER Fig. 12L
MWD-1405
WINTER Fig. 12L



WINTER Fig. 12R
MWD-1406
 WINTER Fig. 12R



WINTER Fig. 14L
MWD-1407
 WINTER Fig. 14L



WINTER Fig. 14R
MWD-1408
 WINTER Fig. 14R



BARRY
MWD-1409
 BARRY



BARRY Fig. 2
MWD-1410
 BARRY Fig. 2



BARRY Fig. 3
MWD-1411
 BARRY Fig. 3



BARRY Fig. 4
MWD-1412
BARRY Fig. 4



BARRY Fig. 11
MWD-1413
BARRY Fig. 11



BARRY Fig. 12
MWD-1414
BARRY Fig. 12



BARRY Fig. 17
MWD-1415
BARRY Fig. 17



BARRY Fig. 18
MWD-1416
BARRY Fig. 18



MWD-1417



SELDIN Fig. 27
MWD-1419
 SELDIN Fig. 27



CRYER Fig. 28
MWD-1420
 CRYER Fig. 28



CRYER Fig. 29
MWD-1421
 CRYER Fig. 29



HEIDBRINK Fig. 22
MWD-1422
 HEIDBRINK Fig. 22



HEIDBRINK Fig. 23
MWD-1423
 HEIDBRINK Fig. 23



MWD-1424



KOPP Fig. 31
MWD-1425
KOPP Fig. 31



KOPP Fig. 32
MWD-1426
KOPP Fig. 32



KOPP Fig. 33
MWD-1427
KOPP Fig. 33



KOPP Fig. 34
MWD-1428
KOPP Fig. 34



KOPP Fig. 35
MWD-1429
KOPP Fig. 35



KOPP Fig. 44
MWD-1430
KOPP Fig. 44



MWD-1431



HEIDBRINK Fig. 10
MWD-1432
HEIDBRINK Fig. 10



WINTER Fig. 11
MWD-1433
WINTER Fig. 11



WINTER Fig. 12
MWD-1434
WINTER Fig. 12



BARRY Fig. 17
MWD-1435
BARRY Fig. 17



BARRY Fig. 18
MWD-1436
BARRY Fig. 18



BARRY Fig. 20
MWD-1437
 BARRY Fig. 20

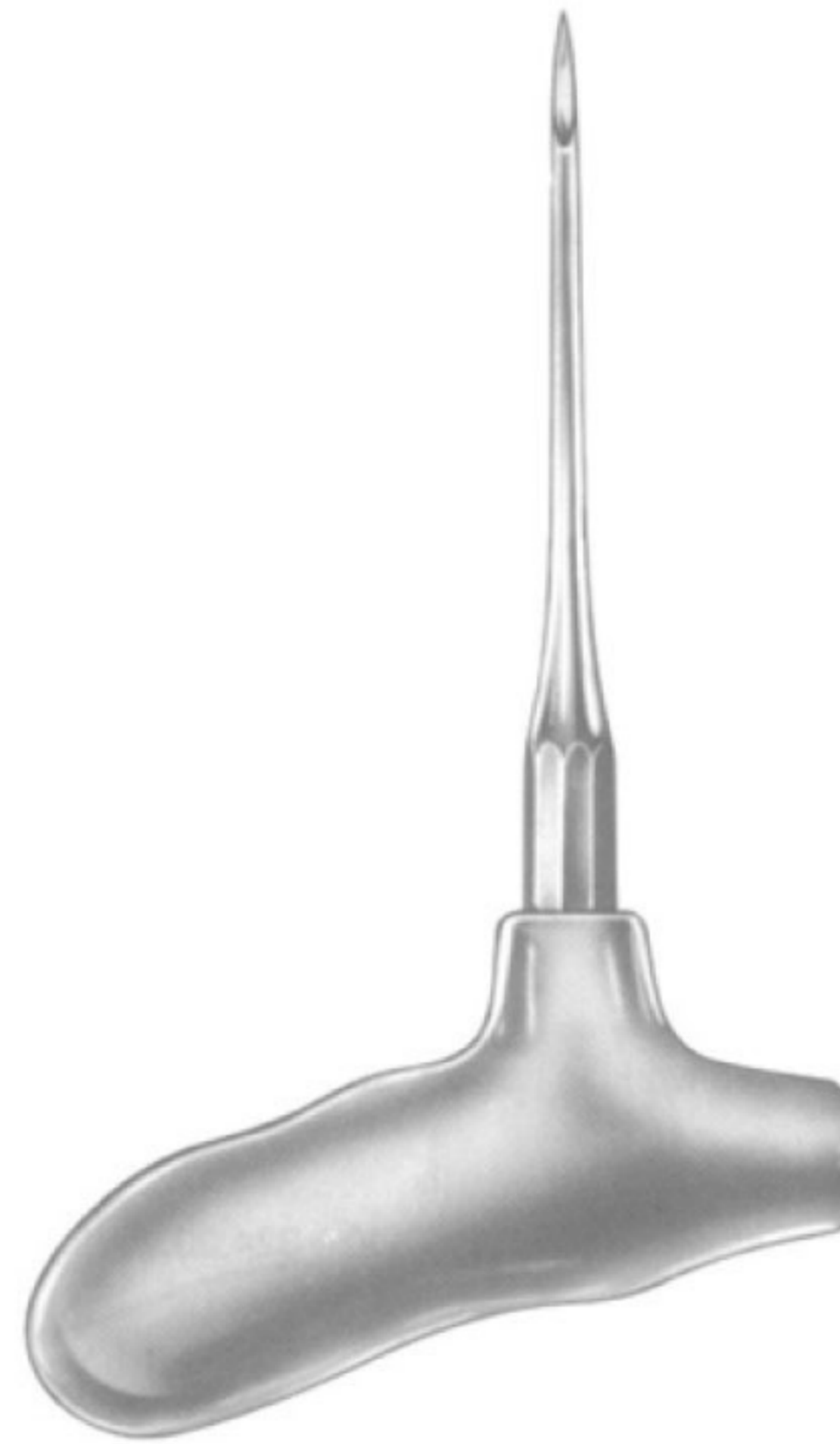

MWD-1438



MWD-1439



MWD-1440



Root Elevator, Plastic Handle, Set of 10 Pcs
MWD-1441
 Root Elevator, Plastic Handle, Set of 10 Pcs



Root Elevator, Plastic Handle, Set of 10 Pcs
Root Elevator, Plastic Handle, Set of 5 Pcs
MWD-1441-B
 Root Elevator, Plastic Handle, Set of 5 Pcs



**Root Elevator, Plastic Handle, Set of 10
Pcsot Elevator, Plastic Handle, Set of 5
Pcs**

MWD-1441C

Root Elevator, Plastic Handle, Set of 10
Pcsot Elevator, Plastic Handle, Set of 5 Pcs



**Root Elevator, Plastic Handle, Set of 10
Pcsot Elevator, Plastic Handle, Set of 5
Pcs**

MWD-1441-D

Root Elevator, Plastic Handle, Set of 10
Pcsot Elevator, Plastic Handle, Set of 5 Pcs



**Root Elevator, Plastic Handle, Set of 10
Pcsot Elevator, Plastic Handle, Set of 5
Pcs**

MWD-1441-E

Root Elevator, Plastic Handle, Set of 10
Pcsot Elevator, Plastic Handle, Set of 5 Pcs



**Root Elevator, Plastic Handle, Set of 10
Pcsot Elevator, Plastic Handle, Set of 5
Pcs**

MWD-1441-F

Root Elevator, Plastic Handle, Set of 10
Pcsot Elevator, Plastic Handle, Set of 5 Pcs



**Root Elevator, Plastic Handle, Set of 10
Pcsot Elevator, Plastic Handle, Set of 5
Pcs**

MWD-1441-G

Root Elevator, Plastic Handle, Set of 10
Pcsot Elevator, Plastic Handle, Set of 5 Pcs



**Root Elevator, Plastic Handle, Set of 10
Pcsot Elevator, Plastic Handle, Set of 5
Pcs**

MWD-1441-H

Root Elevator, Plastic Handle, Set of 10
Pcsot Elevator, Plastic Handle, Set of 5 Pcs



**Root Elevator, Plastic Handle, Set of 10
Pcsot Elevator, Plastic Handle, Set of 5
Pcs**

MWD-1441-I

Root Elevator, Plastic Handle, Set of 10
Pcsot Elevator, Plastic Handle, Set of 5 Pcs



**Root Elevator, Plastic Handle, Set of 10
Pcsot Elevator, Plastic Handle, Set of 5
Pcs**

MWD-1441-J

Root Elevator, Plastic Handle, Set of 10
Pcsot Elevator, Plastic Handle, Set of 5 Pcs



**Root Elevator, Plastic Handle, Set of 5
Pcs**

MWD-1442

Root Elevator, Plastic Handle, Set of 5 Pcs



**Root Elevator, Plastic Handle, Set of 5
Pcs**

MWD-1442-B

Root Elevator, Plastic Handle, Set of 5 Pcs



**Root Elevator, Plastic Handle, Set of 5
Pcs**

MWD-1442-C

Root Elevator, Plastic Handle, Set of 5 Pcs



**Root Elevator, Plastic Handle, Set of 5
Pcs**

MWD-1442-D

Root Elevator, Plastic Handle, Set of 5 Pcs



**Root Elevator, Plastic Handle, Set of 5
Pcs**

MWD-1442-E

Root Elevator, Plastic Handle, Set of 5 Pcs



Fig. 3L
MWD-1443
Fig. 3L



Fig. 7
MWD-1444
Fig. 7



Fig. 5
MWD-1445
Fig. 5



Fig. 5A
MWD-1446
Fig. 5A



Fig. 3
MWD-1447
Fig. 3



Fig. 3G
MWD-1448
Fig. 3G



Fig. 4
MWD-1449
Fig. 4



Handle No. 2 (Standard Double Ended)
MWD-1450
Handle No. 2 (Standard Double Ended)



Handle No. 2 Standard Single Ended
MWD-1451
Handle No. 2 Standard Single Ended



Handle No. 2 Thompson Single Ended
MWD-1452
Handle No. 2 Thompson Single Ended



Handle No. 4
MWD-1453
Handle No. 4



Octagonal Double Ended
MWD-1454
Octagonal Double Ended



**Octagonal Single Ended
MWD-1455**
Octagonal Single Ended



**Handle, Double Ended
MWD-1456**
Handle, Double Ended



**Double Ended
MWD-1457**
Double Ended



**Handle No. 6 Double Ended
MWD-1458**
Handle No. 6 Double Ended



**Tactile Tone Double Ended
MWD-1459**
Tactile Tone Double Ended



**Tactile Tone Single Ended
MWD-1460**
Tactile Tone Single Ended



MWD-1461
1461



MWD-1462
1462



MWD-1463
1463



Fig.6
MWD-1464
Fig.6



Fig.5
MWD-1465
Fig.5



Fig.4
MWD-1466
Fig.4



Fig.4 Rhodium
MWD-1467
Fig.4 Rhodium



Fig.6
MWD-1468
Fig.6



Fig.5
MWD-1469
Fig.5



Fig.4
MWD-1470
Fig.4



Fig.5 Rhodium
MWD-1471
Fig.5 Rhodium



MWD-1472



MWD-1473



MWD-1474



MWD-1475



MWD-1476



Parallelometer mouth mirror
MWD-1477
Parallelometer mouth mirror



Parallelometer mouth mirror + handle
code 2101
MWD-1478
Parallelometer mouth mirror + handle code
2101



Fig.5
MWD-1479
Fig.5



Fig.4
MWD-1480
Fig.4



Fig.5
MWD-1481
Fig.5



Fig.4
MWD-1482
Fig.4



Cone-socket
MWD-1483
Cone-socket



Cone-socket
MWD-1484
Cone-socket



Cone-socket
MWD-1485
Cone-socket



1Y-1Y
MWD-1486
1Y-1Y



1Y-1YS
MWD-1487
1Y-1YS



2Y-3Y
MWD-1488
2Y-3Y



2YS-3YS
MWD-1489
2YS-3YS



2-3
MWD-1490
2-3



2S-3S
MWD-1491
2S-3S



Fig.1
MWD-1492
Fig.1



U15-30
MWD-1493
U15-30



U15-33
MWD-1494
U15-33



H5-33
MWD-1495
H5-33



H6-7
MWD-1496
H6-7



Taylor 2-3
MWD-1497
 Taylor 2-3



CK6
MWD-1498
 CK6



U15
MWD-1499
 U15



No. 3
MWD-1500
 No. 3



No. 12
MWD-1501
 No. 12



WHITESIDE 1-0
MWD-1502
 WHITESIDE 1-0



X WHITESIDE 2-0
MWD-1503
WHITESIDE 2-0



YAOUNGER/GOOD 7-8
MWD-1504
YAOUNGER/GOOD 7-8



H5-33
MWD-1505
H5-33



204SD
MWD-1506
204SD



H6-7
MWD-1507
H6-7



204S
MWD-1508
204S



TOWNER/JAQUETTE U15-30
MWD-1509
 TOWNER/JAQUETTE U15-30



JAQUETTE (33-U15)
MWD-1510
 JAQUETTE (33-U15)



JAQUETTE 2Y-3Y
MWD-1511
 JAQUETTE 2Y-3Y



JAQUETTE 30-U15
MWD-1512
 JAQUETTE 30-U15



JAQUETTE 2YS-3YS
MWD-1513
 JAQUETTE 2YS-3YS



JAQUETTE 33-H5
MWD-1514
 JAQUETTE 33-H5



YOUNGER/GOOD 7-8
MWD-1515
 YOUNGER/GOOD 7-8



204S
MWD-1516
 204S



204SD
MWD-1517
 204SD



H6-7
MWD-1518
 H6-7



JAQUETTE 1Y-1YS
MWD-1520
 JAQUETTE 1Y-1YS



JAQUETTE 2-3
MWD-1521
 JAQUETTE 2-3



JAQUETTE (33-U15)
MWD-1522
 JAQUETTE (33-U15)



S204
MWD-1523
 S204



S204S
MWD-1524
 S204S



S204SD
MWD-1525
 S204SD



Goldman 6-7
MWD-1526
 Goldman 6-7



Goldman Fox 21
MWD-1527
 Goldman Fox 21





H5-U15
MWD-1528
 H5-U15



Jaquette 34-35
MWD-1529
 Jaquette 34-35



Thompson Jr.
MWD-1530
 Thompson Jr.



UT107-108
MWD-1531
 UT107-108



UP128
MWD-1532
 UP128



Jack-Nebraska
MWD-1533
 Jack-Nebraska





Jaquette 1-U15
MWD-1534
 Jaquette 1-U15



Jaquette 2-3
MWD--1535
 Jaquette 2-3



Jaquette 2S-3S
MWD-1536
 Jaquette 2S-3S



Jaquette 30-U15
MWD-1537
 Jaquette 30-U15



Jaquette 30-33
MWD-1538
 Jaquette 30-33



Jaquette 31-32
MWD-1539
 Jaquette 31-32



Jaquette 33-H5
MWD-1540
 Jaquette 33-H5



U 6-7
MWD-1541
 U 6-7



128L
MWD-1542
 128L



MWD-1543



1D
MWD-1544
 1D

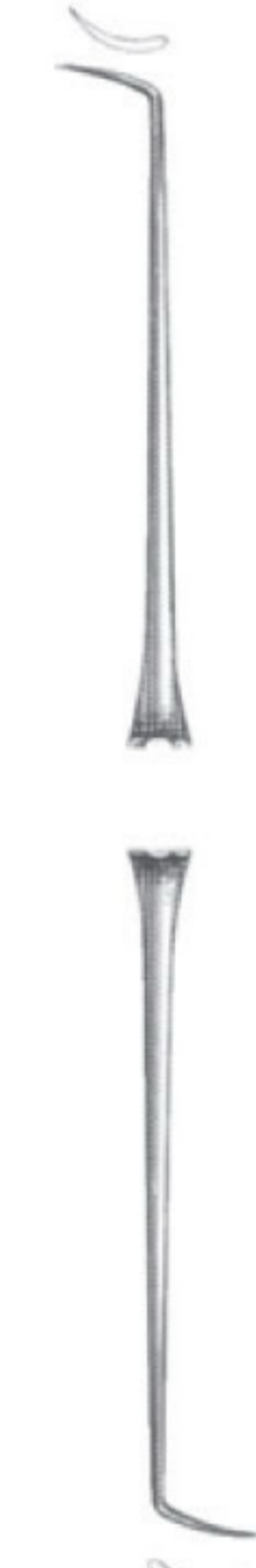

2D
MWD-1545
 2D

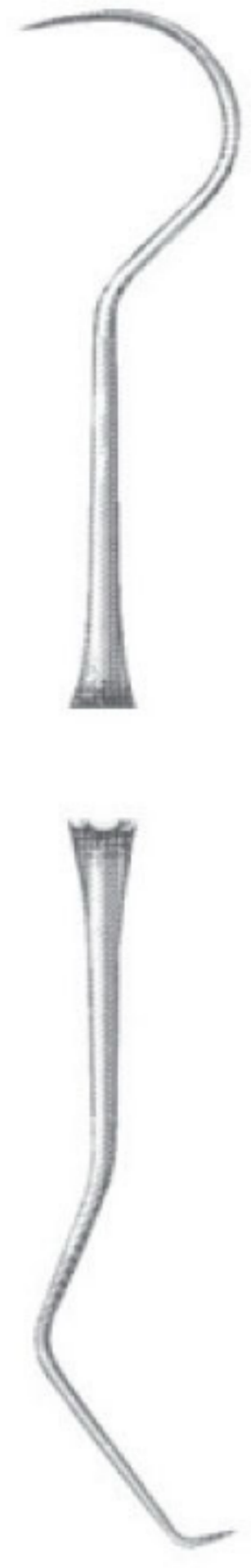

3D
MWD-1546
3D



5D
MWD-1547
5D



6D
MWD-1548
6D



MWD-1549



1
MWD-1550
1

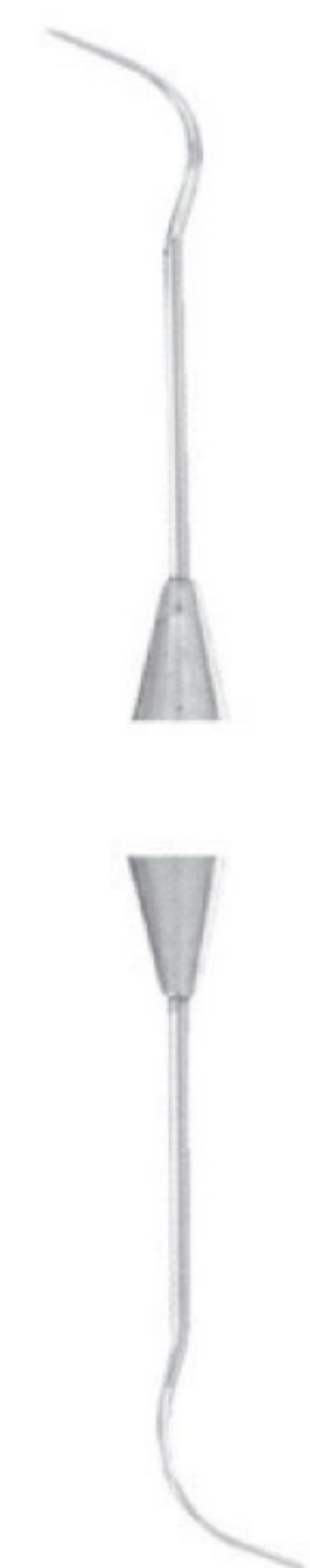

2A
MWD-1551
2A



2SL
MWD-1552
2SL

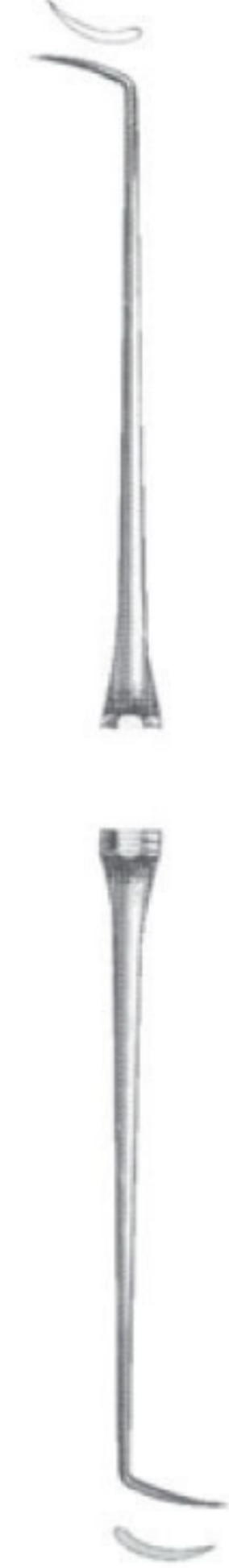

3
MWD-1553
3



3ES
MWD-1554
3ES



3CH
MWD-1555
3CH

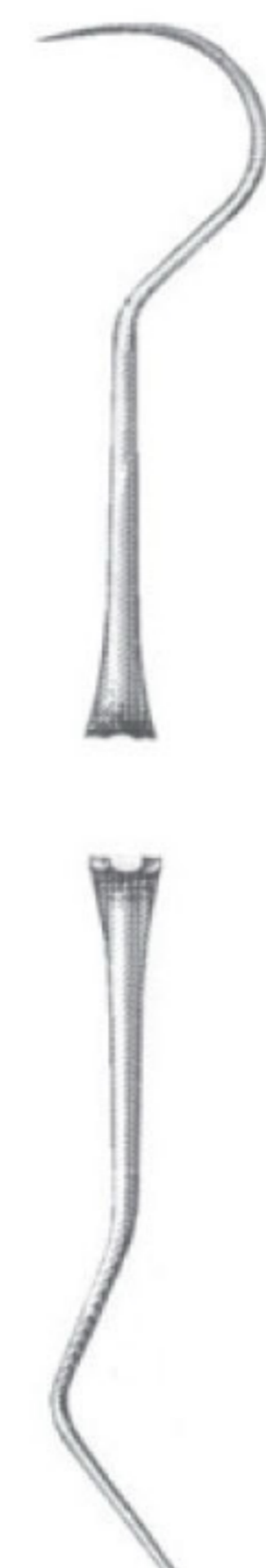

5
MWD-1556
5



3ML
MWD-1557
3ML



7
MWD-1558
7

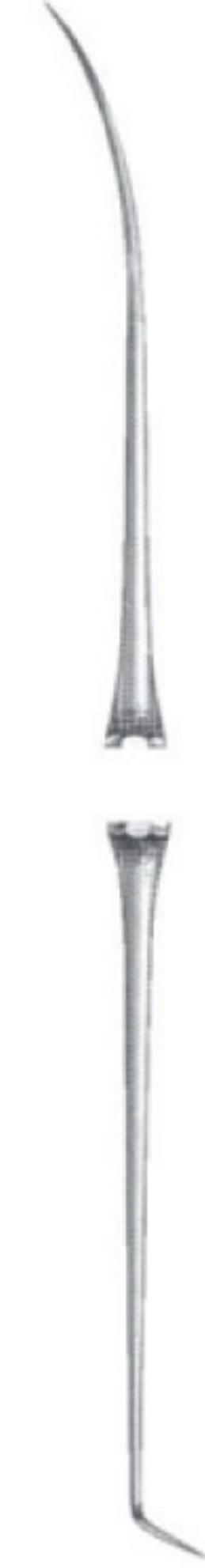

6
MWD-1559
6

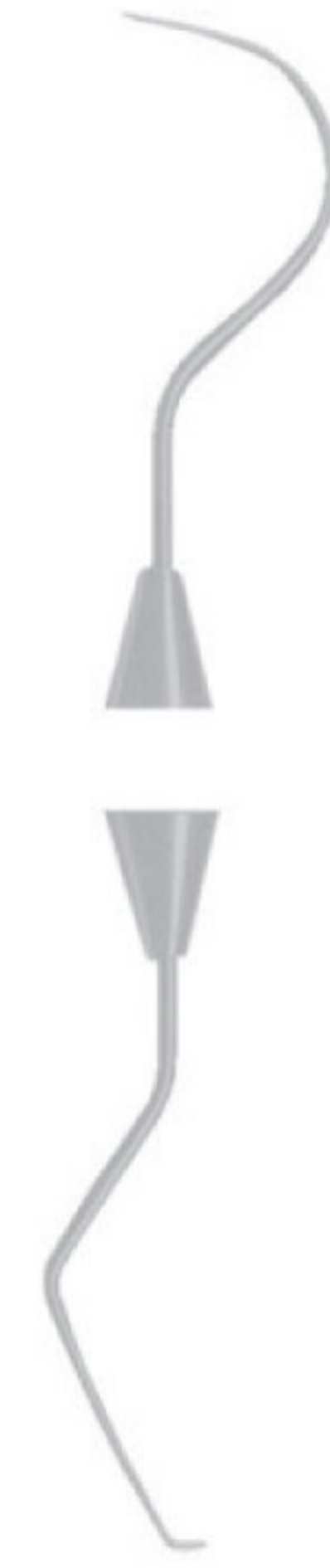

TUFTS 17-23
MWD-1560
TUFTS 17-23



2A
MWD-1561
2A



2
MWD-1562
2



2SL
MWD-1563
2SL



3CH
MWD-1564
3CH



3ML
MWD-1565
3ML



6
MWD-1566
6



16
MWD-1567
16



1
MWD-1568
1



3
MWD-1569
3



3ES
MWD-1570
3ES



5
MWD-1571
5

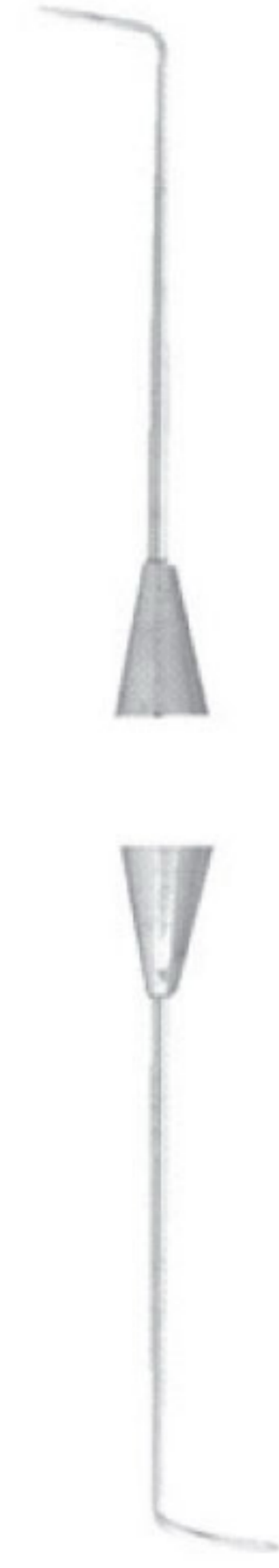

7
MWD-1572
7

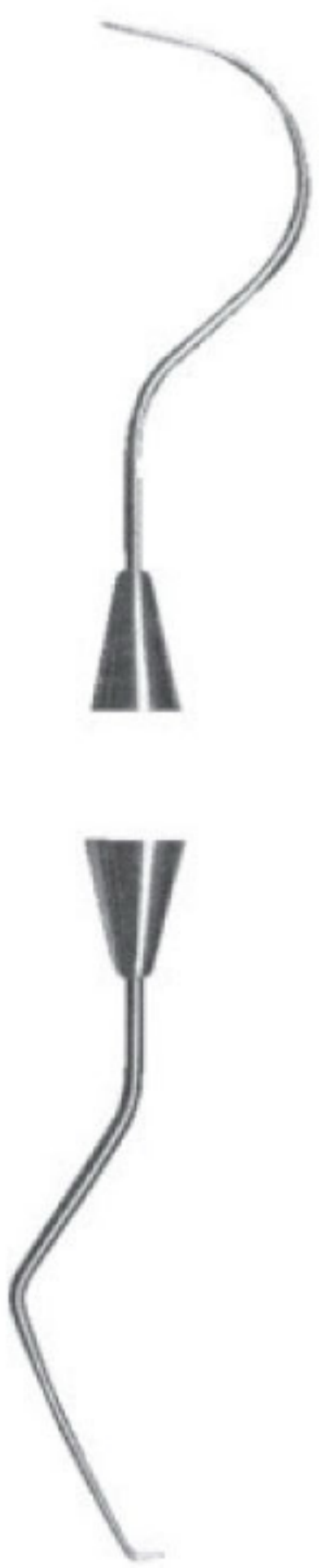

TUFTS 17/23
MWD-1573
TUFTS 17/23



Fig. 3A
MWD-1574
Fig. 3A



Fig. 6
MWD-1575
Fig. 6



Fig. 7
MWD-1576
Fig. 7



Fig. 17
MWD-1577
Fig. 17



Fig. 23
MWD-1578
Fig. 23



Fig. 3A
MWD-1579
Fig. 3A



Fig. 6
MWD-1580
Fig. 6



Fig. 7
MWD-1581
Fig. 7



Fig.17
MWD-1582
Fig.17



Fig.23
MWD-1583
Fig.23



GF-17
MWD-1584
GF-17

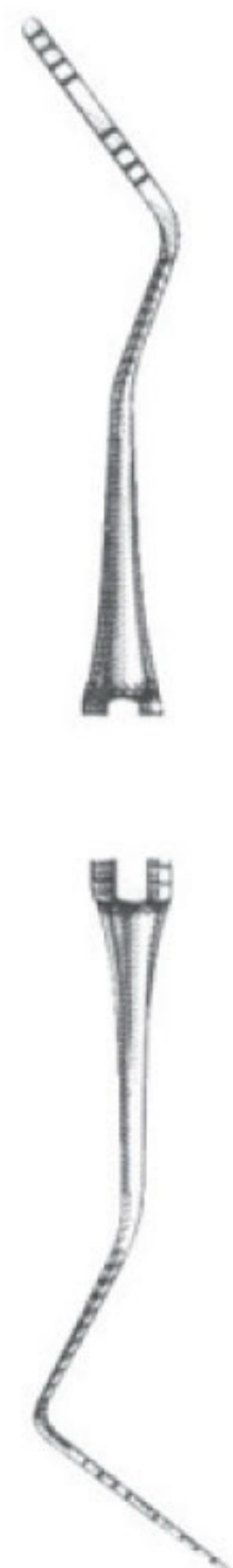

GF-18 (1-2)
MWD-1585
GF-18 (1-2)



1UNC15
MWD-1586
1UNC15



4UNC15
MWD-1587
4UNC15



Baylor 1-2
MWD-1588
 Baylor 1-2

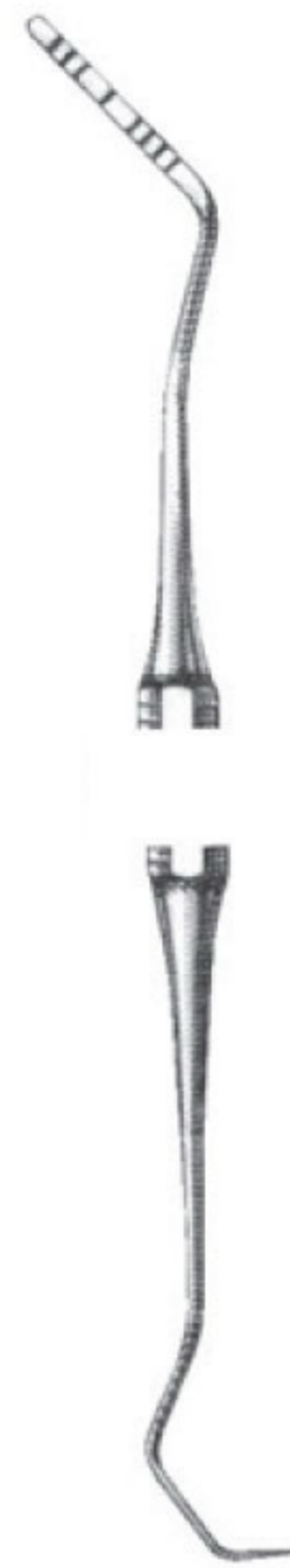

Gf17
MWD-1589
 Gf17



GF18 (1-2)
MWD-1590
 GF18 (1-2)



Nabor 2
MWD-1591
 Nabor 2



4UNC15
MWD-1592
 4UNC15



1UNC15
MWD-1593
 1UNC15



Baylor 1-2
MWD-1594
 Baylor 1-2



GF18 1-2(Probe 2 end is flat)
MWD-1595
 GF18 1-2(Probe 2 end is flat)



Nabor 2
MWD-1596
 Nabor 2



C
MWD-1597
 3-6-9-12



X2
MWD-1598
 X2



C
MWD-1599
 C3-6-9-12



Fig. 1 (Williams)
MWD-1600
Fig. 1 (Williams)



Fig. 2
MWD-1601
Fig. 2



Goldman Fox
MWD-1602
Goldman Fox



Fig. O (Michigan)
MWD-1603
Fig. O (Michigan)



WHO (PSR)
MWD-1604
WHO (PSR)



UNC15
MWD-1605
UNC15



X2
MWD-1606
X2



Fig. 1 (Williams)
MWD-1607
Fig. 1 (Williams)



Goldman Fox
MWD-1608
Goldman Fox



OW
MWD-1609
OW



Fig. O (Michigan)
MWD-1610
Fig. O (Michigan)



UNC15
MWD-1611
UNC15



WHO (PSR)
MWD-1612
 WHO (PSR)



X2
MWD-1613
 X2 3 6 9 12



0-23
MWD-1614
 0-23



0W23
MWD-1615
 0W23



PE1-23(1-23)
MWD-1616
 PE1-23(1-23)



WHO23
MWD-1617
 WHO23



4-23
MWD-1618
4-23

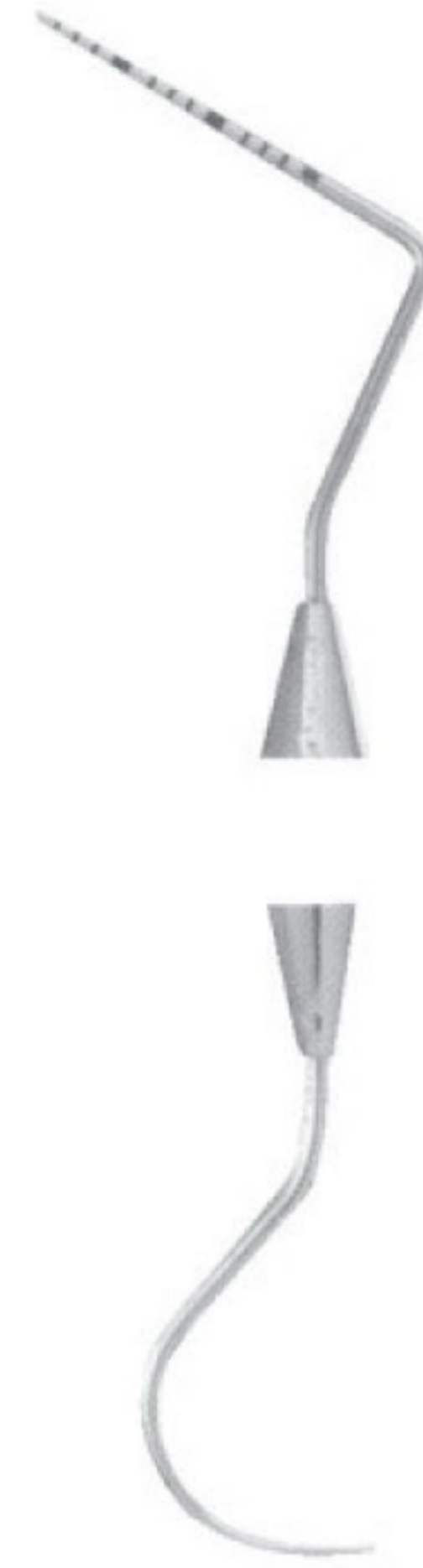

UNC15-23
MWD-1619
UNC15-23



0-23
MWD-1620
0-23



0W23
MWD-1621
0W23



PE1-23(1-23)
MWD-1622
PE1-23(1-23)



4-23
MWD-1623
4-23



UNC15-23
MWD-1624
UNC15-23



WHO23
MWD-1625
WHO23



TF13 Root Canal 1-3
MWD-1626
 TF13 Root Canal 1-3



TF57 Root Canal 5-7
MWD-1627
 TF57 Root Canal 5-7



UF30 *ISO-30
MWD-1628
 UF30 *ISO-30



UF40 *ISO-40 (8)
MWD-1629
 UF40 *ISO-40 (8)



UF50 *ISO-50 (7)
MWD-1630
 UF50 *ISO-50 (7)



UF65 *ISO-65
MWD-1631
 UF65 *ISO-65



UF80 *ISO-80
MWD-1632
 UF80 *ISO-80



UF90 *ISO-90
MWD-1633
 UF90 *ISO-90



UF110 *ISO-110
MWD-1634
 UF110 *ISO-110



UF60 *ISO-60
MWD-1635
 UF60 *ISO-60



TF911 Root Canal 9-11
MWD-1636
 TF911 Root Canal 9-11



UF35 *ISO-35
MWD-1637
 UF35 *ISO-35



UF45 *ISO-45
MWD-1638
UF45 *ISO-45



UF55 *ISO-55 (9)
MWD-1639
UF55 *ISO-55 (9)



UF70 *ISO-70
MWD-1640
UF70 *ISO-70



UF85 *ISO-85
MWD-1641
UF85 *ISO-85



UF100 *ISO-100
MWD-1642
UF100 *ISO-100



UF110 *ISO-130
MWD-1643
UF110 *ISO-130



UF120X
MWD-1644
UF120X



UF45N
MWD-1645
UF45N



UF60N
MWD-1646
UF60N



UF80N
MWD-1647
UF80N



UF100X
MWD-1648
UF100X



UE25 R-25
MWD-1649
UE25 R-25



UE30 R-30
MWD-1650
UE30 R-30



UE35 R-35
MWD-1651
UE35 R-35



UE40 R-40
MWD-1652
UE40 R-40



UE45 R-45
MWD-1653
UE45 R-45



UE50 R-50
MWD-1654
UE50 R-50



UF120X
MWD-1655
UF120X



UF140X
MWD-1656
 UF140X



TFD3545N
MWD-1657
 TFD3545N



TFD6080N
MWD-1658
 TFD6080N



UE55 R-55
MWD-1659
 UE55 R-55



UE60 R-60
MWD-1660
 UE60 R-60



UE25N R-25
MWD-1661
 UE25N R-25



UE30N R-30
MWD-1662
UE30N R-30



UE40N R-40
MWD-1663
UE40N R-40



No. D11
MWD-1664
D1 .33mm, D16 .95mm



No. D11T D1 .24mm, D2 .84mm
MWD-1665
D1 .24mm, D2 .84mm



No. KR1 D1 .23mm, D2 .61mm
MWD-1666
D1 .23mm, D2 .61mm



No. 25S D1 .26mm, D2 .53mm
MWD-1667
D1 .26mm, D2 .53mm



No. W1S D1 .25mm, D16 .55mm
MWD-1668
D1 .25mm, D16 .55mm



No. W2S D1 .40mm, D2 .70mm
MWD-1669
D1 .40mm, D2 .70mm



Lucks No.1
MWD-1670
Lucks No.1



Lucks No.2
MWD-1671
Lucks No.2



Lucks No.3
MWD-1672
Lucks No.3



Lucks No.4
MWD-1673
Lucks No.4

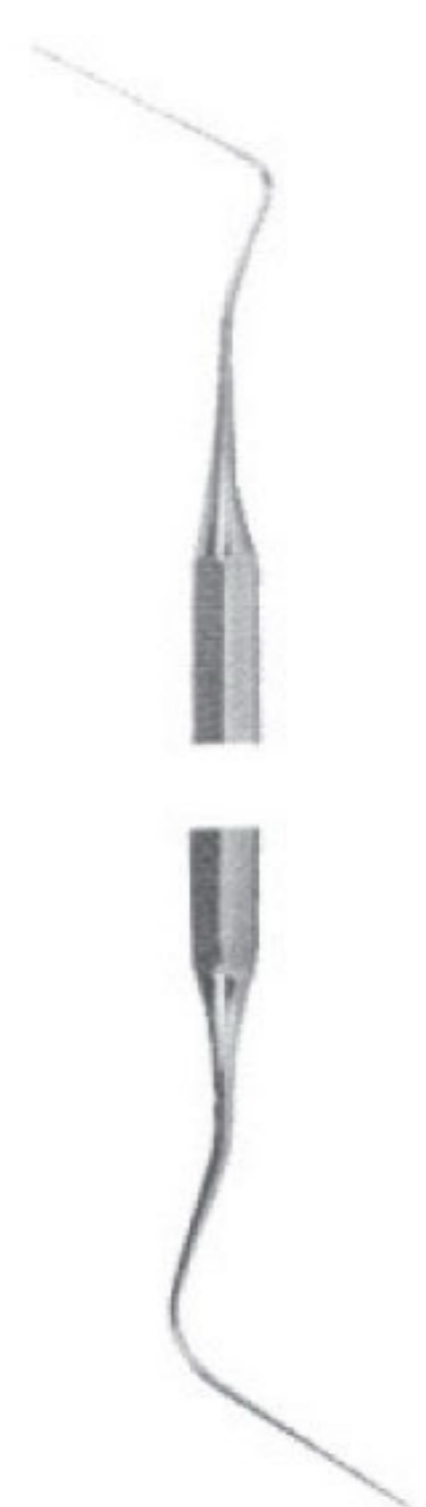

**No. 5, D(1mm).50mm, .55mm D(5mm)
D(16mm), 85mm, .75mm D(16mm)
MWD-1674**

D(1mm).50mm, .55mm D(5mm) D(16mm),
85mm, .75mm D(16mm)

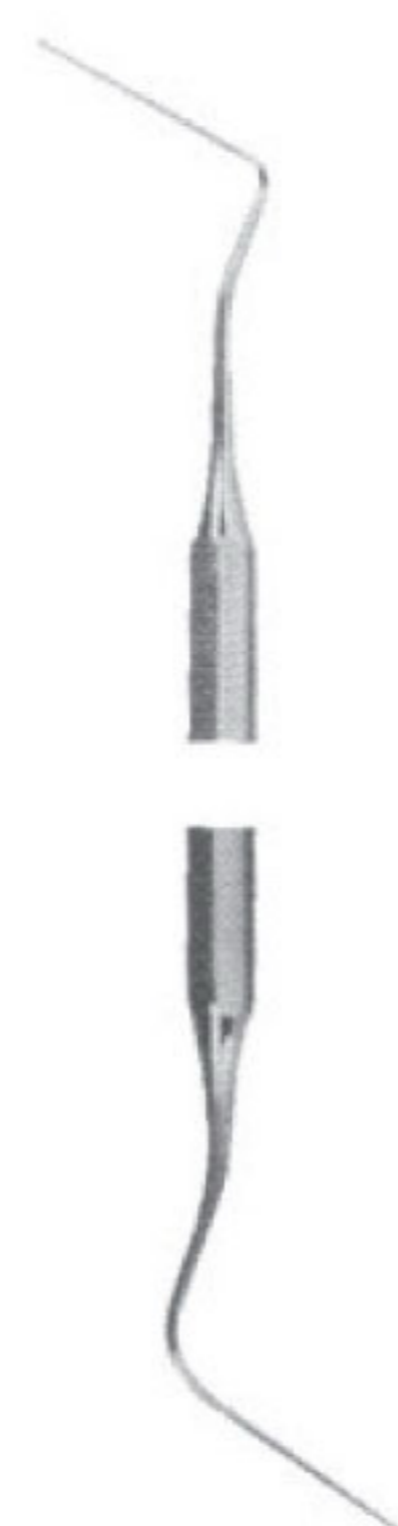

**No. 7, D(1mm).70mm, .50mm D(5mm)
D(16mm), 1.00mm, .75mm D(16mm)
MWD-1675**

D(1mm).70mm, .50mm D(5mm) D(16mm),
1.00mm, .75mm D(16mm)



**No. 9, D(1mm)1.00mm, .63mm D(5mm)
D(16mm), 1.30mm, .75mm D(16mm)
MWD-1676**

D(1mm)1.00mm, .63mm D(5mm) D(16mm),
1.30mm, .75mm D(16mm)

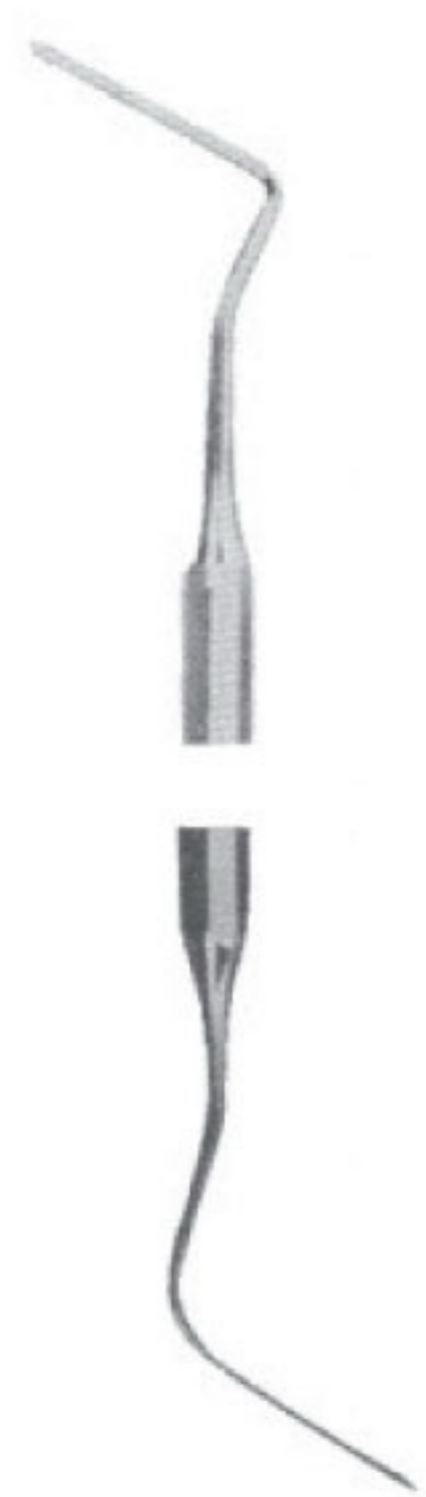

**No. 11, D(1mm)1.20mm, .63mm D(5mm)
D(16mm), 1.50mm, .75mm D(16mm)
MWD-1677**

D(1mm)1.20mm, .63mm D(5mm) D(16mm),
1.50mm, .75mm D(16mm)



**No.1 (D1 .35mm, D16 .75mm)
MWD-1678**

(D1 .35mm, D16 .75mm)



**No.2 D1 .55mm, D16 .85mm
MWD-1679**

D1 .55mm, D16 .85mm



No.3 D1 .85mm, D16 1.15mm
MWD-1680
 D1 .85mm, D16 1.15mm



No.4 D1 1.00mm, D16 1.30mm
MWD-1681
 D1 1.00mm, D16 1.30mm



No.1-3 - D1 .25mm/D1 .35mm
MWD-1682
 D1 .25mm/D1 .35mm



No.3-5 - D1 .35mm/D1 .55mm
MWD-1683
 D1 .35mm/D1 .55mm



No.5-7 - D1 .55mm/D1 .70mm
MWD-1684
 D1 .55mm/D1 .70mm



No.9-11 - D1 1.00mm/D1 1.20mm
MWD-1685
 D1 1.00mm/D1 1.20mm



No. 14
MWD-1686
No. 14



No. 17
MWD-1687
No. 17



No. 18
MWD-1688
No. 18



No. 19
MWD-1689
No. 19



No. 38/639
MWD-1690
No. 38/639



No. 61/62
MWD-1691
No. 61/62



No. 31L
MWD-1692
No. 31L



No. 33L
MWD-1693
No. 33L



No. 22
MWD-1694
No. 22



No. 3/6
MWD-1695
No. 3/6



No. 89/92
MWD-1696
No. 89/92



1mm Discoid (10-7-14)
MWD-1697
1mm Discoid (10-7-14)



1mm Discoid (38-39) (11.5-7-14)
MWD-1698
 1mm Discoid (38-39) (11.5-7-14)



E2 Discoid (15-9-15)
MWD-1699
 E2 Discoid (15-9-15)



1.5mm Discoid (15-8-14)
MWD-1700
 1.5mm Discoid (15-8-14)



E3 Discoid (25-9-15)
MWD-1701
 (25-9-15)



2mm Discoid (20-9-14)
MWD-1702
 2mm Discoid (20-9-14)



1.5mm Spoon (15-8-14)
MWD-1703
 1.5mm Spoon (15-8-14)



E1 Discoid (12-9-15)
MWD-1704
 E1 Discoid (12-9-15)



2mm Spoon (20-9-14)
MWD-1705
 Spoon (20-9-14)



17 Tear-Drop
MWD-1706
 17 Tear-Drop



19 Tear-Drop
MWD-1707
 19 Tear-Drop



18 Tear-Drop
MWD-1708
 18 Tear-Drop



20 Tear-Drop
MWD-1709
 20 Tear-Drop



31L
MWD-1710
31L



31W
MWD-1711
31W



33L
MWD-1712
33L



32L
MWD-1713
32L



G16D-L
MWD-1714
G16D-L



Explorer No.2
MWD-1715
Explorer No.2



Explorer No.16
MWD-1716
 Explorer No.16

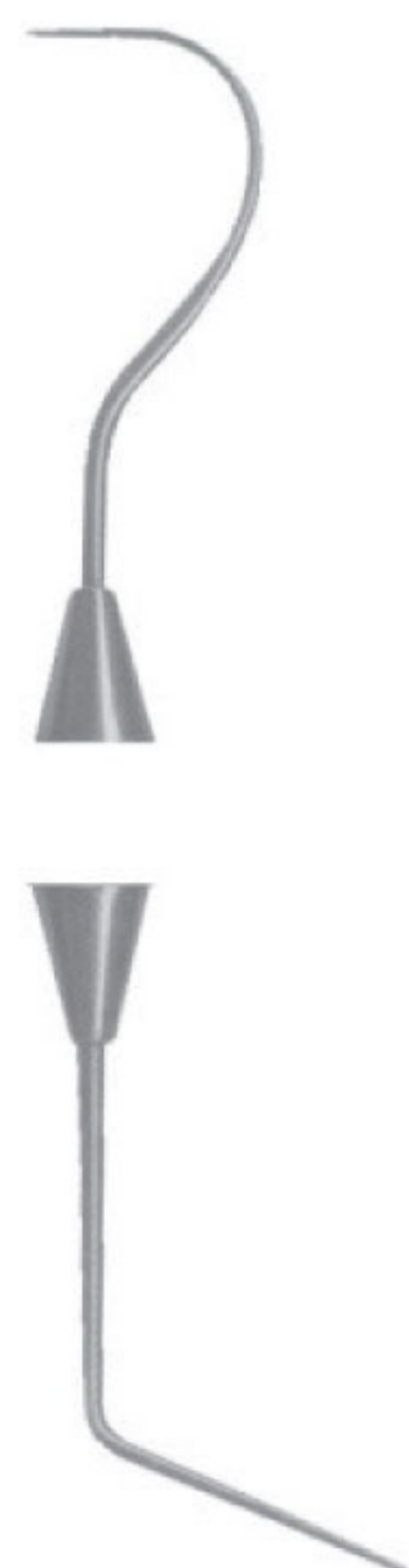

16-23 Explorer
MWD-1717
 16-23 Explorer



16-17 Explorer
MWD-1718
 16-17 Explorer



DG16 Explorer
MWD-1719
 DG16 Explorer



(Heavy DG-16)
MWD- 1720
 (Heavy DG-16)



1D
MWD-1721
 1D



2D
MWD-1722
2D



3D
MWD-1723
3D



5D
MWD-1724
5D



6D
MWD-1725
6D



7D
MWD-1726
7D



3A-S
MWD-1727
3A-S



6S
MWD-1728
6S



7S
MWD-1729
7S



17S
MWD-1730
17S



23S
MWD-1731
23S



No. 2D-L
MWD-1732
No. 2D-L



No. 3D-L
MWD-1733
No. 3D-L



No. 3CHD-L
MWD-1734
No. 3CHD-L



No. 5D-L
MWD-1735
No. 5D-L



No. G16D-L
MWD-1736
No. G16D-L



No. 3AS-L
MWD-1737
No. 3AS-L



No. 6S-L
MWD-1738
No. 6S-L



No. 17S-L
MWD-1739
No. 17S-L



No. 23S-L
MWD-1740
No. 23S-L



Gf17 Probe/Explorer
MWD-1741
Gf17 Probe/Explorer



PE 1-23 Probe/Explorer
MWD-1742
PE 1-23 Probe/Explorer



Probe 0 / 23 Explorer (fine)
MWD-1743
Probe 0 / 23 Explorer (fine)



Probe 1 / 23 Explorer
MWD-1744
Probe 1 / 23 Explorer



Probe OW / 23 Explorer
MWD-1745
Probe OW / 23 Explorer



Probe 4 / 23 Explorer
MWD-1746
 Probe 4 / 23 Explorer

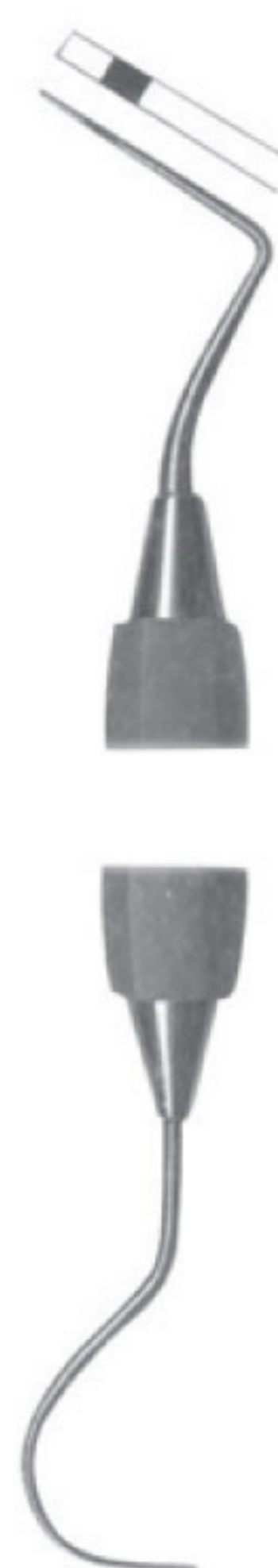

Ball Tip Probe WHO / 23 Explorer
MWD-1747
 Ball Tip Probe WHO / 23 Explorer



Gf18 Probe
MWD-1748
 Gf18 Probe



"C" Probe
MWD-1749
 "C" Probe



X2 Probe
MWD-1750
 X2 Probe



1-2 (Probe 2 end is flat)
MWD-1751
 1-2 (Probe 2 end is flat)



1 UNC 15
MWD-1752
1 UNC 15



4 SE
MWD-1753
4 SE



MWD-1754
1754



Fig. 1
MWD_1754
Fig. 1



Fig. 2
MWD-1755
Fig. 2



Fig. 1
MWD-1756
Fig. 1



BLOOMFIELD Fig. 2 (off angle)
MWD-1757
 BLOOMFIELD Fig. 2 (off angle)



CSI-1 (slightly serrated on ends)
MWD-1758
 CSI-1 (slightly serrated on ends)



1mm (10-7-14)
MWD-1759
 1mm (10-7-14)



1.3mm (13-10-16)
MWD-1760
 1.3mm (13-10-16)



1.5mm (15-8-14)
MW-1761
 1.5mm (15-8-14)



1mm (10-8-16)
MWD-1762
 1mm (10-8-16)



UWH 18-19
MWD-1763
UWH 18-19



UWH 16-18
MWD-1764
UWH 16-18



UWH 20-21
MWD-1765
UWH 20-21





BEHRMAN (Fig. 1)
MWD-1766
 BEHRMAN (Fig. 1)



BLACK (Fig. 1-2)
MWD-1767
 BLACK (Fig. 1-2)



MORQUETTE (Fig. 0/1)
MWD-1768
 MORQUETTE (Fig. 0/1)



Black Action 11/12 Plugger
MWD-1769
 Black Action 11/12 Plugger



Hollenback No.1 Plugger
MWD-1770
 Hollenback No.1 Plugger



Hollenback No. 2 Plugger
MWD-1771
 Hollenback No. 2 Plugger





Blacks 0-1 (1mm-1.5mm)
MWD-1773
 Blacks 0-1 (1mm-1.5mm)



Blacks 1-2 (1.5mm-2.5mm)
MWD-1774
 Blacks 1-2 (1.5mm-2.5mm)



Bodkin 1 (.7mm-1mm)
MWD-1775
 Bodkin 1 (.7mm-1mm)



Bodkin 2 (1.5mm-2mm)
MWD-1776
 Bodkin 2 (1.5mm-2mm)



2.5mm-3mm
MWD-1777
 2.5mm-3mm



Oregon 2
MWD-1778
 Oregon 2



.7mm-1mm
MWD-1779
.7mm-1mm



1mm-1.5mm
MWD-1780
1mm-1.5mm



1.5mm-2mm
MWD-1781
1.5mm-2mm



Oregon (Fig. 3)
MWD-1782
Oregon (Fig. 3)



Oregon (Fig. 4)
MWD-1783
Oregon (Fig. 4)



UP 12
MWD-1784
UP 12





Applicator 1-2
MWD-1785
Applicator 1-2



Birtles Applicator Spatula K
MWD-1787
Birtles Applicator Spatula K



Fig. 1
MWD-1788
Fig. 1



Fig. 28/29
MWD-1789
Fig. 28/29



Fig. 34
MWD-1790
Fig. 34



Fig. 27/29
MWD-1791
Fig. 27/29



Fig. 21B
MWD-1792
 Fig. 21B



ACORN Fig. 21
MWD-1793
 ACORN Fig. 21



21 Acorn
MWD-1794
 21 Acorn



Fig. 21B
MWD-1795
 Fig. 21B



Fig. 2-34
MWD-1796
 Fig. 2-34



1797
MWD-1797





Fig. 26-28
MWD-1798
Fig. 26-28



Fig. 2-30
MWD-1799
Fig. 2-30



Fig. 26-30
MWD-1800
Fig. 26-30



Fig. 27-29
MWD-1801
Fig. 27-29



PKT 1
MWD-1802
PKT 1



Fig. 27-30
MWD-1803
Fig. 27-30





PKT 2
MWD-1804
PKT 2



Fig. 34T
MWD-1805
Fig. 34T



Fig. 3
MWD-1806
Fig. 3



PKT 3
MWD-1807
PKT 3



PFI 21
MWD-1808
PFI 21



PKT 3P
MWD-1809
PKT 3P





Pitts Pedo 19
MWD-1810
Pitts Pedo 19



PKT 4
MWD-1811
PKT 4



Pitts Pedo 18
MWD-1812
Pitts Pedo 18



PKT 5
MWD-1813
PKT 5





HOLLENBACK Fig. 3
MWD-1814
 HOLLENBACK Fig. 3



HOLLENBACK Fig. 3S
MWD-1815
 HOLLENBACK Fig. 3S



WARD Fig. 1
MWD-1816
 WARD Fig. 1



WARD Fig. 2
MWD-1817
 WARD Fig. 2



WALL Fig. 1
MWD-1818
 WALL Fig. 1



WALL Fig. 3
MWD-1819
 WALL Fig. 3



**Fig. 3/6 Cleoid/Discoïd
MWD-1820**
Fig. 3/6 Cleoid/Discoïd

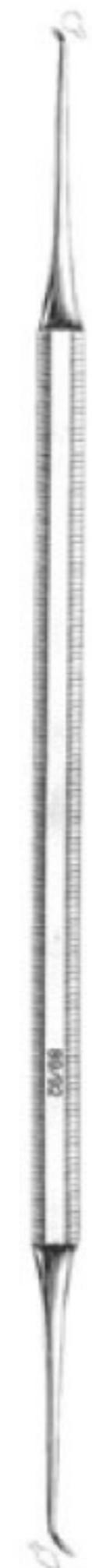

**Fig. 89/92 Cleoid/Discoïd
MWD-1821**
Fig. 89/92 Cleoid/Discoïd



**1.5mm Cleoid Discoïd (Shown with GTX
Finish)
MWD-1822**
1.5mm Cleoid Discoïd (Shown with GTX
Finish)



**2mm Cleoid Discoïd
MWD-1823**
2mm Cleoid Discoïd



**3mm Cleoid Discoïd
MWD-1824**
3mm Cleoid Discoïd



**FRAHM Fig. 2-3 (off-angle)
MWD-1825**
FRAHM Fig. 2-3 (off-angle)





Interproximal 1
MWD-1826
 Interproximal 1



Interproximal 1
MWD-1827
 Interproximal 1



Baum Interproximal
MWD-1828
 Baum Interproximal



Sho A Carver
MWD-1829
 Sho A Carver



Thompson 2
MWD-1830
 Thompson 2



GOLLOBIN Fig. 1
MWD-1831
 GOLLOBIN Fig. 1





HOLLENBACK Fig. 1/2
MWD-1832
HOLLENBACK Fig. 1/2



HOLLENBACK Fig. 3
MWD-1833
HOLLENBACK Fig. 3



THOMPSON (Fig. 3) (½ Hollenback Hoe & Wall 3)
MWD-1834
THOMPSON (Fig. 3) (½ Hollenback Hoe & Wall 3)



THOMPSON (Fig. 5) (½ Hollenback Hoe & Tanner 5)
MWD-1835
THOMPSON (Fig. 5) (½ Hollenback Hoe & Tanner 5)



THOMPSON (Fig. 8) (3mm Cleoid & Wall 3)
MWD-1836
THOMPSON (Fig. 8) (3mm Cleoid & Wall 3)



THOMPSON (Fig. 9) (Hollenback 3 & Wall 3)
MWD-1837
THOMPSON (Fig. 9) (Hollenback 3 & Wall 3)



WARD Fig. 2
MWD-1838
WARD Fig. 2



Composite Interproximal
MWD-1839
Composite Interproximal



TANNER Fig. 5
MWD-1840
TANNER Fig. 5



TANNER Fig. 6
MWD-1841
TANNER Fig. 6



THARP Fig. 1
MWD-1842
THARP Fig. 1



THOMPSON Fig. 1
MWD-1843
THOMPSON Fig. 1





University of Minnesota Fig. 1
MWD-1844
 University of Minnesota Fig. 1

University of Minnesota Fig. 2
MWD-1845
 University of Minnesota Fig. 2

UPR Fig. 1
MWD-1846
 UPR Fig. 1

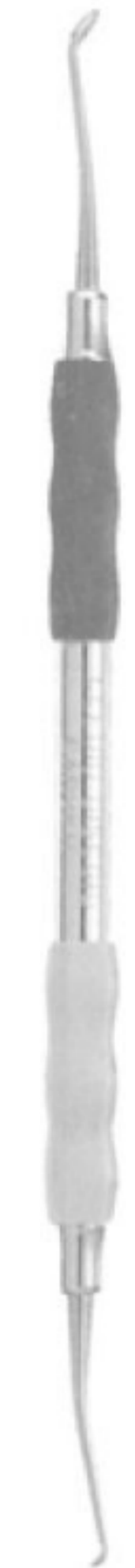

WALL Fig. 3
MWD-1847
 WALL Fig. 3

Contour Carbide (Fig. 1-2)
MWD-1848
 Contour Carbide (Fig. 1-2)

Cleoid Discoid
MWD-1849
 Cleoid Discoid



Contour Carbide (Fig. 10-11)
MWD-1850
 Contour Carbide (Fig. 10-11)

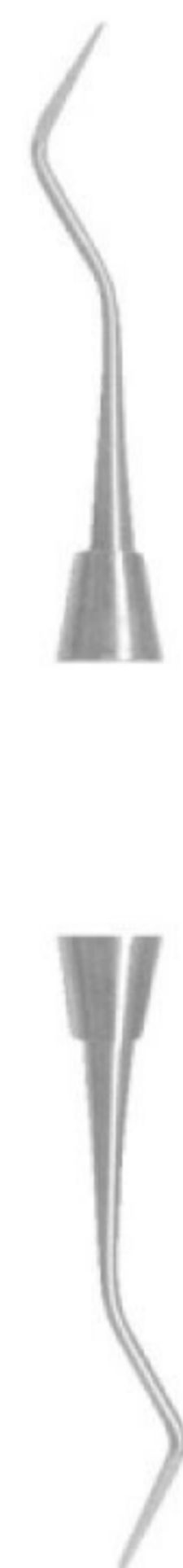

1.5mm Bin-Angle (15-8-8)
MWD-1851
 1.5mm Bin-Angle (15-8-8)



1.5mm Straight (15)
MWD-1852
 1.5mm Straight (15)



1mm Wedelstaedt (10-15-3)
MWD-1853
 1mm Wedelstaedt (10-15-3)



1.5mm Wedelstaedt (15-15-3)
MWD-1854
 1.5mm Wedelstaedt (15-15-3)



2mm Wedelstaedt (20-15-3)
MWD-1855
 2mm Wedelstaedt (20-15-3)



F-Type 1
MWD-1856
F-Type 1



F-Type 2
MWD-1857
F-Type 2



F-Type 3
MWD-1858
F-Type 3



F-Type 4
MWD-1859
F-Type 4



F-Type 5
MWD-1860
F-Type 5



F-Type 6
MWD-1861
F-Type 6



G-Type 1
MWD-1862
 G-Type 1



G-Type 2
MWD-1863
 G-Type 2



G-Type 3
MWD-1864
 G-Type 3



G-Type 4
MWD-1865
 G-Type 4



Fig. 2
MWD-1866
 Fig. 2



Fig. 3 (off-set blade)
MWD-1867
 Fig. 3 (off-set blade)



Fig. 4
MWD-1868
Fig. 4



Fig. 5
MWD-1869
Fig. 5



Fig. 6
MWD-1870
Fig. 6



Fig.7
MWD-1871
Fig.7



Fig.8
MWD-1872
Fig.8



Fig.9
MWD-1873
Fig.9





Fig.11
MWD-1874
Fig.11



Fig.12
MWD-1875
Fig.12



Fig.15
MWD-1876
Fig.15



JORDAN Fig. 2
MWD-1877
JORDAN Fig. 2



FREEDMAN Fig. 1
MWD-1878
FREEDMAN Fig. 1



FREEDMAN Fig. 2
MWD-1879
FREEDMAN Fig. 2





FREEDMAN Fig. 3
MWD-1880
FREEDMAN Fig. 3



Dr. Dan
MWD-1881
Dr. Dan



SIMON Fig. 2
MWD-1882
SIMON Fig. 2



K-Type 1
MWD-1883
K-Type 1



K-Type 2
MWD-1884
K-Type 2

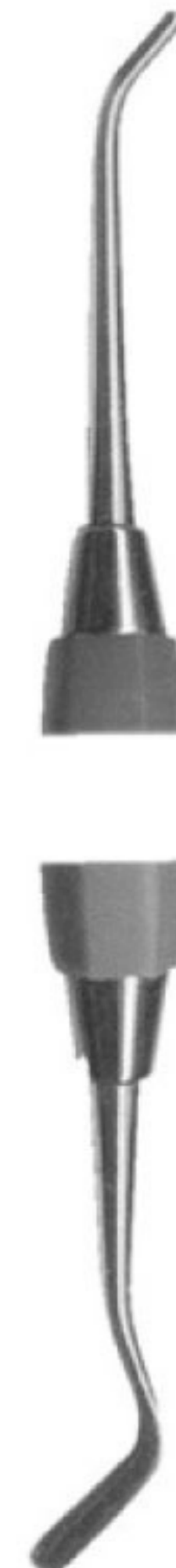

K-Type 3
MWD-1885
K-Type 3





K-Type 4
MWD-1886
K-Type 4

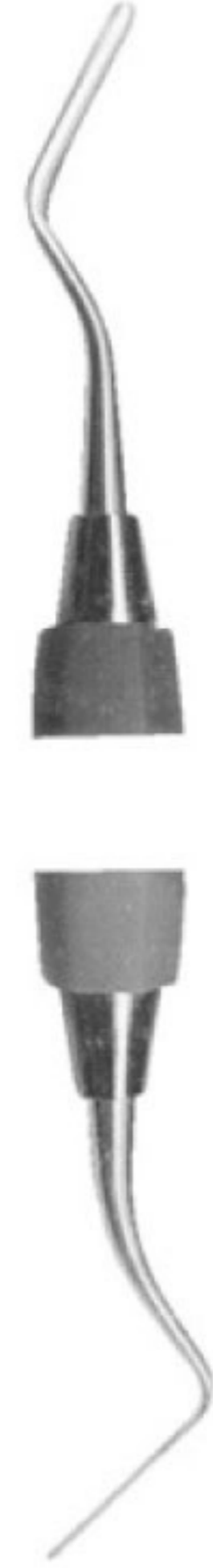

K-Type 5
MWD-1887
K-Type 5



K-Type 6 Carbide
MWD-1888
K-Type 6 Carbide



No.3
MWD-1889
No.3



No.4
MWD-1890
No.4



No.5
MWD-1891
No.5



LADMORE Fig. 3
MWD-1892
 LADMORE Fig. 3



WOODSON Fig. 1
MWD-1893
 WOODSON Fig. 1



WOODSON Fig. 2
MWD-1894
 WOODSON Fig. 2



WOODSON Fig. 3
MWD-1895
 WOODSON Fig. 3



W-3
MWD-1896
 W-3



Gregg 4/5
MWD-1897
 Gregg 4/5



Fig. 5-7
MWD-1898
Fig. 5-7



Fig.1
MWD-1899
Fig.1



Fig. 3
MWD-1900
Fig. 3



Fig. 4
MWD-1901
Fig. 4



Fig. 5-7
MWD-1902
Fig. 5-7



Fig. 8A
MWD-1903
Fig. 8A





GLICK Fig.1
MWD-1904
 GLICK Fig.1



P8
MWD-1905
 P8



WOODSON Fig. 1
MWD-1906
 WOODSON Fig. 1



WOODSON Fig. 2
MWD-1907
 WOODSON Fig. 2



WOODSON Fig. 3
MWD-1908
 WOODSON Fig. 3



WOODSON Fig. 2
MWD-1907
 WOODSON Fig. 2



WOODSON Fig. 3
MWD-1908
 WOODSON Fig. 3



RULE 3-4
MWD-1909
RULE 3-4



GRACEY GC 1-2
MWD-1910
GRACEY GC 1-2



GRACEY GC 3-4
MWD-1911
GRACEY GC 3-4



GRACEY GC 5-6
MWD-1912
GRACEY GC 5-6



GRACEY GC 7-8
MWD-1913
GRACEY GC 7-8



GRACEY GC 9-10
MWD-1914
GRACEY GC 9-10



GRACEY GC 11-12
MWD-1915
GRACEY GC 11-12



G1-2
MWD-1917
G1-2



G3-4
MWD-1918
G3-4



G5-6
MWD-1919
G5-6



G7-8
MWD-1920
G7-8



G9-10
MWD-1921
G9-10



G11-12
MWD-1922
G11-12



G13-14
MWD-1923
G13-14



COLUMBIA 4R-4L
MWD-1924
COLUMBIA 4R-4L



COLUMBIA 13-14
MWD-1925
COLUMBIA 13-14



MCCALLS 17-18
MWD-1927
MCCALLS 17-18



BARNHART 1-2
MWD-1928
BARNHART 1-2



BARNHART 5-6
MWD-1929
BARNHART 5-6



LANGER 1-2
MWD-1930
LANGER 1-2



LANGER 3-4
MWD-1931
LANGER 3-4



LANGER 5-6
MWD-1932
LANGER 5-6



4L-4R
MWD-1933
4L-4R



13-14
MWD-1934
13-14



2L-2R
MWD-1935
2L-2R



13-14
MWD-1936
13-14



17-18
MWD-1938
17-18



17S-18S
MWD-1939
17S-18S



Universal Scaler
MWD-1940
Universal Scaler



GF2 Curette
MWD-1941
GF2 Curette



GF3 Curette
MWD-1942
GF3 Curette



GF4 Curette
MWD-1943
GF4 Curette



GF6 Hoe
MWD-1945
GF6 Hoe



GF 7 Knife
MWD-1946
GF 7 Knife



GF 8 Spear Knife
MWD-1947
GF 8 Spear Knife



GF 9 Knife Scaler
MWD-1948
GF 9 Knife Scaler



GF 11 Spear Knife
MWD-1949
 GF 11 Spear Knife



GF 21 Sharp Spoon / Small Scaler
MWD-1950
 GF 21 Sharp Spoon / Small Scaler



COLUMBIA (2L-2R)
MWD-1951
 COLUMBIA (2L-2R)



MCCALL (13-14)
MWD-1952
 MCCALL (13-14)



MCCALL (17S-18S)
MWD-1953
 MCCALL (17S-18S)



Root Plane (1-2)
MWD-1954
 Root Plane (1-2)



Root Plane (5-6)
MWD-1955
 Root Plane (5-6)



Root Plane (7-8)
MWD-1956
 Root Plane (7-8)

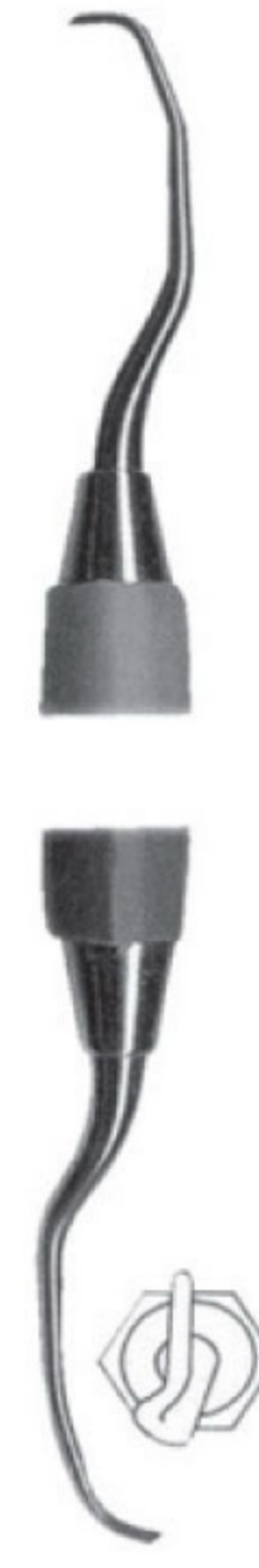

Root Plane (11-12)
MWD-1957
 Root Plane (11-12)



Root Plane (13-14)
MWD-1958
 Root Plane (13-14)



Petite (1-2)
MWD-1959
 Petite (1-2)

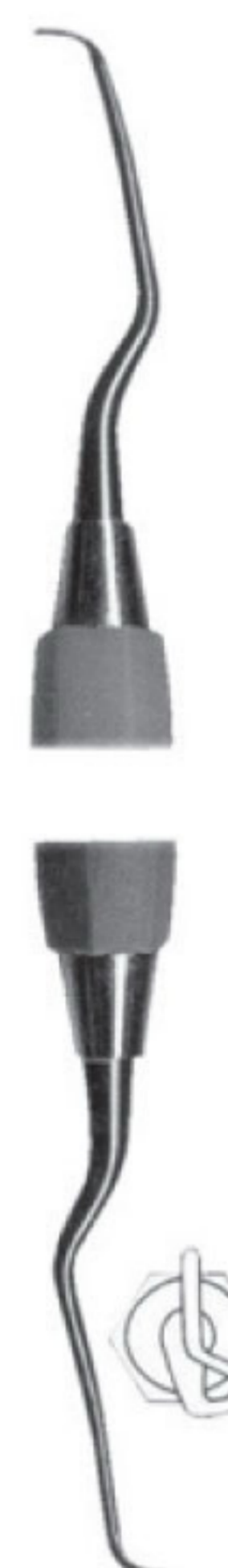

Petite (11-12)
MWD-1960
 Petite (11-12)



Petite (5-6)
MWD-1961
 Petite (5-6)



Petite (13-14)
MWD-1962
 Petite (13-14)



BARNHART (5-6)
MWD-1964
 BARNHART (5-6)



GRACEY (1-2)
MWD-1965
 GRACEY (1-2)



GRACEY (3-4)
MWD-1966
 GRACEY (3-4)



GRACEY (5-6)
MWD-1967
 GRACEY (5-6)



GRACEY (7-8)
MWD-1968
 GRACEY (7-8)



GRACEY (9-10)
MWD-1969
 GRACEY (9-10)



GRACEY (11-12)
MWD-1970
 GRACEY (11-12)



GRACEY (13-14)
MWD-1971
 GRACEY (13-14)



GRACEY (2L-2R)
MWD-1972
 GRACEY (2L-2R)



COLUMBIA (4L-4R)
MWD-1973
 COLUMBIA (4L-4R)





COLUMBIA (13-14)
MWD-1974
 COLUMBIA (13-14)



LANGER (1-2)
MWD-1975
 LANGER (1-2)



LANGER (3-4)
MWD-1976
 LANGER (3-4)



LANGER (5-6)
MWD-1977
 LANGER (5-6)



MCCALL (13-14)
MWD-1978
 MCCALL (13-14)



MCCALL (17-18)
MWD-1980
 MCCALL (17-18)





MCCALL (17S-18S)
MWD-1981
MCCALL (17S-18S)



RULE (3-4)
MWD-1982
RULE (3-4)



MWD-1983



MWD-1984



MWD-1985



MWD-1986



MWD-1987



MWD-1988



MWD-1989



MWD-1990



MWD-1991



MWD-1992



MWD-1993



MWD-1994



MWD-1995



MWD-1996



MWD-1997



MWD-1998



ROACH-A
MWD-1999
 ROACH-A



ROACH-B
MWD-2000
 ROACH-B



LECRON 5-B
MWD-2002
 LECRON 5-B



VEHE-A
MWD-2003
 VEHE-A



VEHE-B
MWD-2004
 VEHE-B



A7
MWD-2005
 A7



B7
MWD-2006
B7



WARD 2-A
MWD-2007
WARD 2-A



WARD 2-B
MWD-2008
WARD 2-B



PKT 1
MWD-2009
PKT 1



PKT 2
MWD-2010
PKT 2



PKT 3
MWD-2011
PKT 3



PKT 4
MWD-2012
PKT 4



PKT 5
MWD-2013
PKT 5



Hollenback 3
MWD-2014
Hollenback 3



Hollenback 3S
MWD-2015
Hollenback 3S



WARD 1
MWD-2016
WARD 1



WARD 2
MWD-2017
WARD 2



WALL 1
MWD- 2018
WALL 1



WALL 3
MWD-2019
WALL 3



Le Cron
MWD-2020
Le Cron



Le Cron
MWD-2021
Le Cron



Le Cron
MWD-2022
Le Cron



MSY
MWD-2023
MSY



MSY
MWD-2024
MSY



Le Cron
MWD-2025
Le Cron



Hylin
MWD-2026
Hylin



Hylin
MWD-2027
Hylin



Hylin
MWD-2028
Hylin



Zahle
MWD-2029
Zahle



Zahle
MWD-2030
Zahle



Zahle
MWD-2031
Zahle



Gritman
MWD-2032
Gritman



Beale
MWD-2033
Beale



Roach
MWD-2034
Roach



Vehe
MWD-2035
Vehe



Fig.0
MWD-2036
Fig.0



Fig.1
MWD-2037
Fig.1



Fig.2
MWD-2038
Fig.2



Fig.3
MWD-2039
Fig.3



Fig.4
MWD-2040
Fig.4



Weston Fig.3
MWD-2041
Weston Fig.3



Fig.1
MWD-2042
Fig.1



Fig.1
MWD-2043
Fig.1



LECRON Inlay
MWD-2044
LECRON Inlay



REEVES
MWD-2045
REEVES



VEHE Wax
MWD-2046
VEHE Wax



ROACH Wax
MWD-2047
ROACH Wax



W-31
MWD-2048
W-31



W-5
MWD-2049
W-5



W-7
MWD-2050
W-7



W-7A
MWD-2051
W-7A



W-7G
MWD-2052
W-7G



AGATHE
MWD-2053
AGATHE



C-7
MWD-2054
C-7



C-5
MWD-2055
C-5



C-313
MWD-2056
C-313



C-24A Rigid
MWD-2057
C-24A Rigid



C-24 Flexible
MWD-2058
C-24 Flexible



C-24 Flexible
MWD-2059
C-24 Flexible



24
MWD-2060
24



C-7
MWD-2054
C-7



24
MWD-2060
24



A6
MWD-2061
A6



26
MWD-2062
26



7 Wax
MWD-2063
7 Wax



**All Metal Spatulas with High Polish
Stainless Steel Blade**
MWD-2064
All Metal Spatulas with High Polish Stainless
Steel Blade



31
MWD-2065
31



Fig. 1 18.5 cm
MWD-2066
Fig. 1 18.5 cm



Fig. 2 18 cm
MWD-2067
Fig. 2 18 cm



Fig. 3 18.5 cm
MWD-2068
Fig. 3 18.5 cm



Fig. 4 19.5 cm
MWD-2069
Fig. 4 19.5 cm



Fig. 5 21.5 cm
MWD-2070
Fig. 5 21.5 cm



Fig. 6 20.5 cm
MWD-2071
Fig. 6 20.5 cm



Fig. 7 19.5 cm
MWD-2072
Fig. 7 19.5 cm



Fig. 8 20 cm
MWD-2073
Fig. 8 20 cm



Fig. 9 22.5 cm
MWD-2074
Fig. 9 22.5 cm



Hirshfeld 3-7
MWD-2075
Hirshfeld 3-7



Hirshfeld 5-11
MWD-2076
Hirshfeld 5-11



Hirshfeld 9-10
MWD-2077
Hirshfeld 9-10

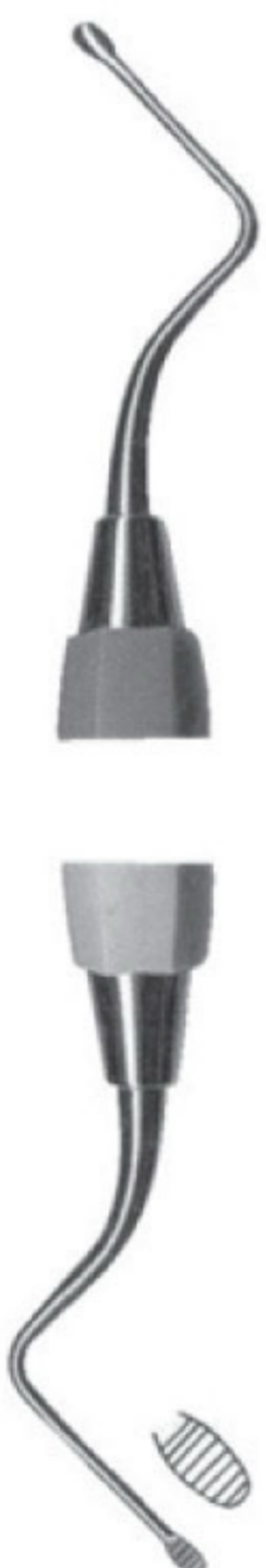

Orban 10-11
MWD-2078
Orban 10-11



Orban 6-7
MWD-2079
2079



Orban 8-9
MWD-2080
Orban 8-9



UWH 16-18
MWD-2081
 UWH 16-18



UWH 18-19
MWD-2082
 UWH 18-19



UWH 20-21
MWD-2083
 UWH 20-21



2084
MWD-2084
 2084



Orban Knife (1-2)
MWD-2085
 Orban Knife (1-2)



1 SE
MWD-2086
 1 SE



2-3
MWD-2087
2-3



Kirkland 13-13L
MWD-2088
Kirkland 13-13L



Knife Orban 1-2 TT DEO
MWD-2089
Knife Orban 1-2 TT DEO



Fahnenstock Fig, 1 12,5cm
MWD-2090
Fahnenstock Fig, 1 12,5cm



Fahnenstock Fig, 2 17cm
MWD-2091
Fahnenstock Fig, 2 17cm



Lessmann Fig, 1 12,5cm
MWD-2092
Lessmann Fig, 1 12,5cm



Lessmann Fig, 2 17cm
MWD-2093
 Lessmann Fig, 2 17cm



Con scodellino Fig, 1 12,5cm
MWD-2094
 Con scodellino Fig, 1 12,5cm



Con scodellino Fig, 2 17cm
MWD-2095
 Con scodellino Fig, 2 17cm



Ermert
MWD-2096
 Ermert



Ermert
MWD-2097
 Ermert



18 cm 71/8"
MWD-2098
 18 cm 71/8"



18 cm 7 1/8"
MWD-2099
18 cm 7 1/8"



17 cm 6 3/4" Gritman
MWD-2100
17 cm 6 3/4" Gritman



17 cm 6 3/4" Medicon
MWD-2101
17 cm 6 3/4" Medicon



Fig, 1 17 cm
MWD-2102
Fig, 1 17 cm



22 cm 8 3/4"
MWD-2103
22 cm 8 3/4"



22 cm 8 3/4"
MWD-2104
22 cm 8 3/4"



Gritman Fig, 2 17 cm
MWD-2105
 Gritman Fig, 2 17 cm



Fig, 3 16 cm
MWD-2106
 Fig, 3 16 cm



Fig, 4 16 cm
MWD-2107
 Fig, 4 16 cm



Ck1 Pocket Marker
MWD-2108
 Ck1 Pocket Marker



Ck2 Pocket Marker
MWD-2109
 Ck2 Pocket Marker



Knife
MWD-2110
 Knife



Dissector
MWD-2111
Dissector



Scaler
MWD-2112
Scaler



Ochsenbein Fig. 1
MWD-2113
Ochsenbein Fig. 1



Ochsenbein Fig. 2
MWD-2114
Ochsenbein Fig. 2



Ochsenbein Fig. 4
MWD-2115
Ochsenbein Fig. 4



No. 75
MWD-2116
No. 75



No. 85
MWD-2117
No. 85



No. 86
MWD-2118
No. 86



No.87
MWD-2119
No.87



No. 2/4
MWD-2120
No. 2/4



No.1
MWD-2121
No.1



No. 2
MWD-2122
No. 2



No. 4
MWD-2123
No. 4



No. 5L
MWD-2124
No. 5L



No.6R
MWD-2125
No.6R

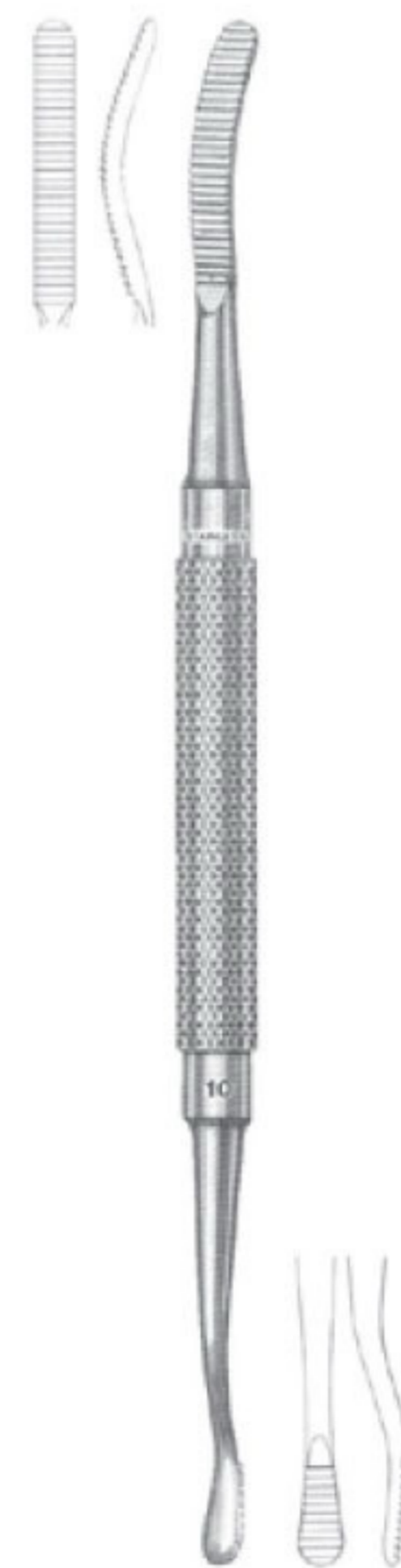

No. 10
MWD-2126
No. 10

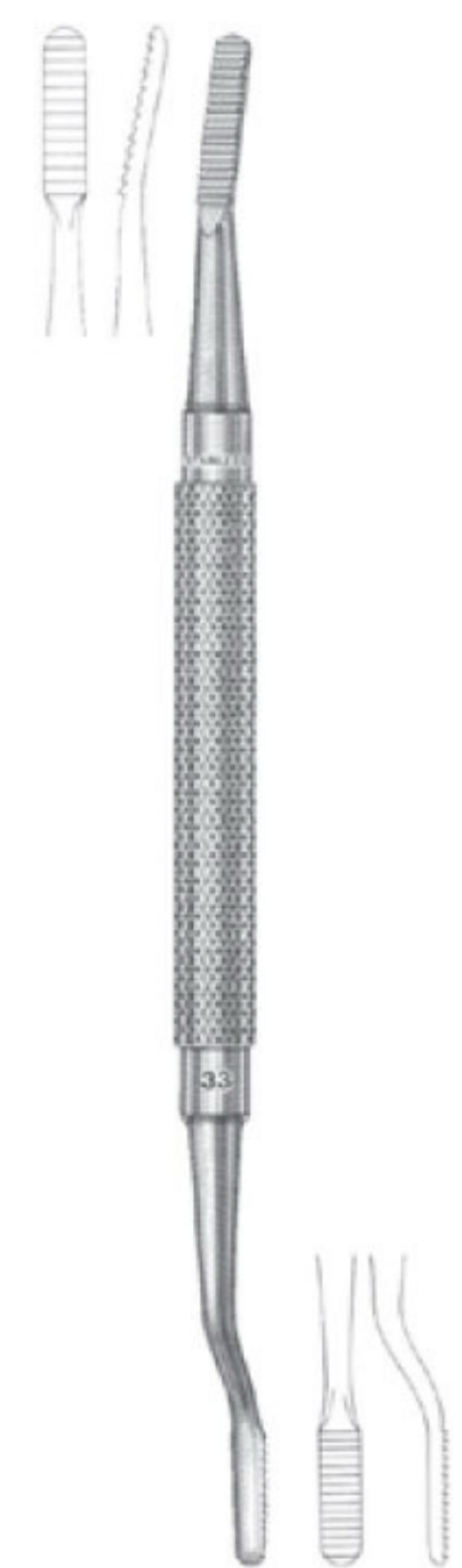

No. 33
MWD-2127
No. 33

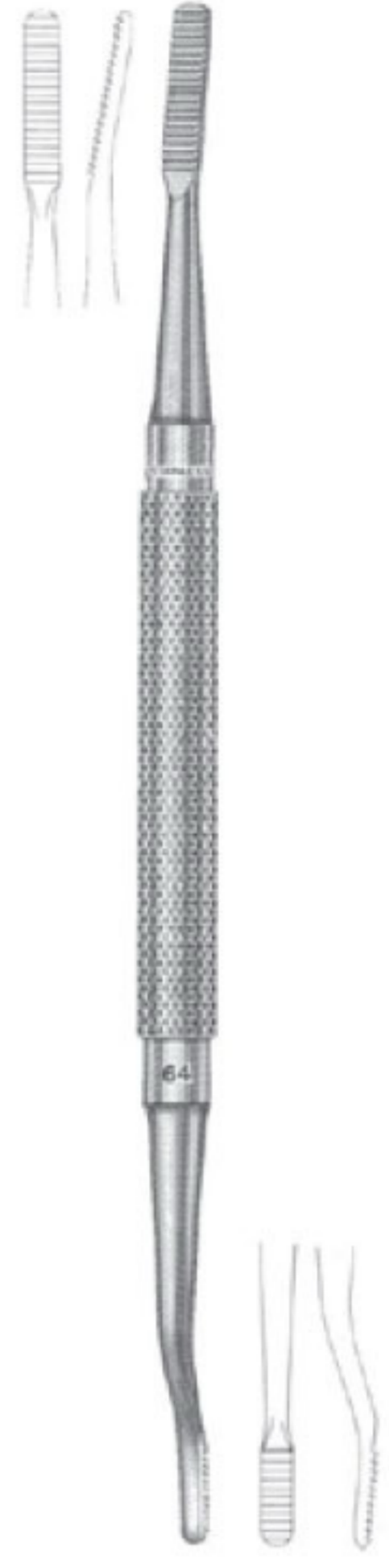

MILLER No. 33
MWD-2128
 MILLER No. 33

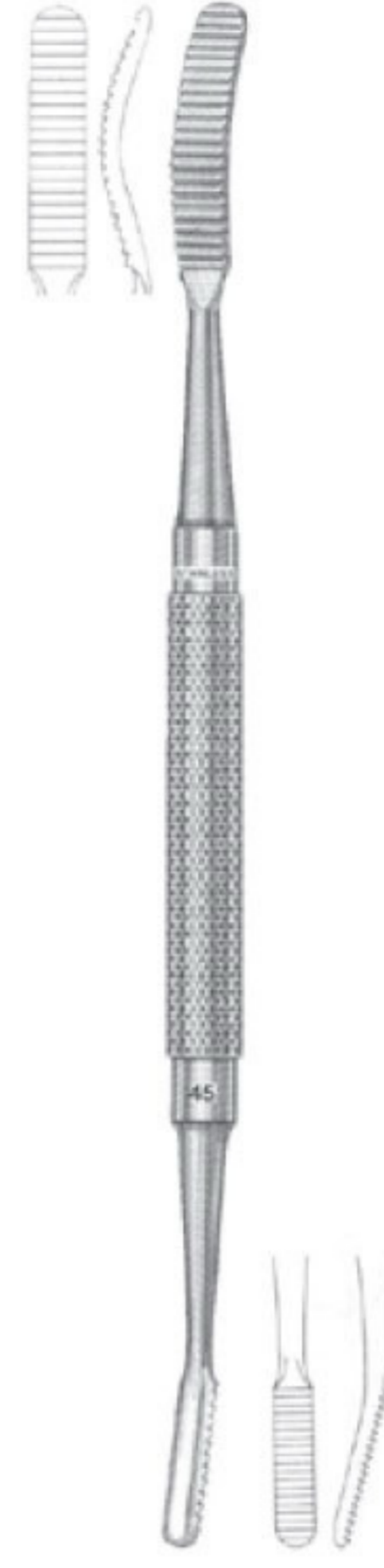

MILLER No. 64
MWD-2129
 MILLER No. 64

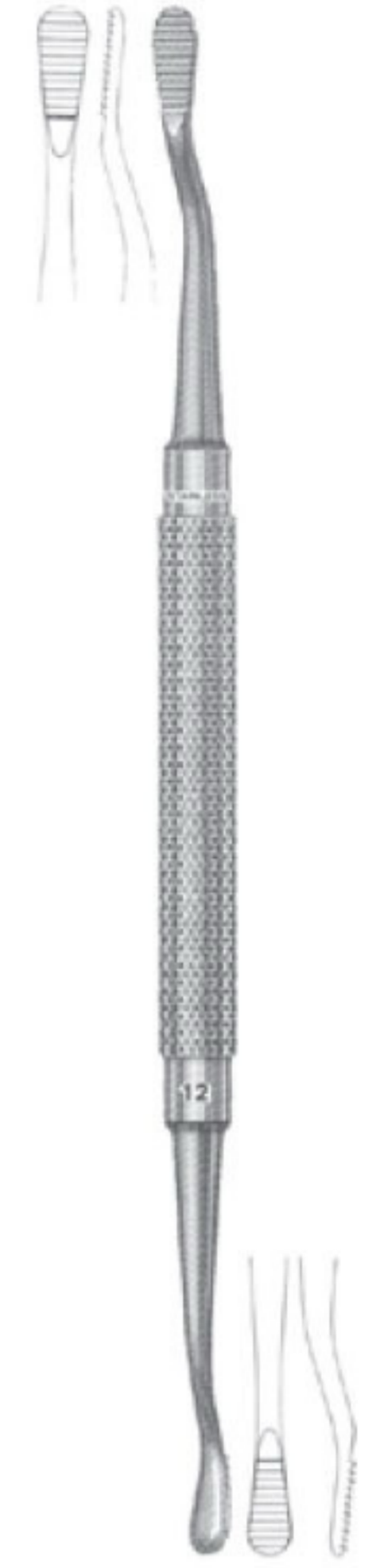

HOWARD No. 12
MWD-2130
 HOWARD No. 12



HOWARD No. 12A
MWD-2131
 HOWARD No. 12A

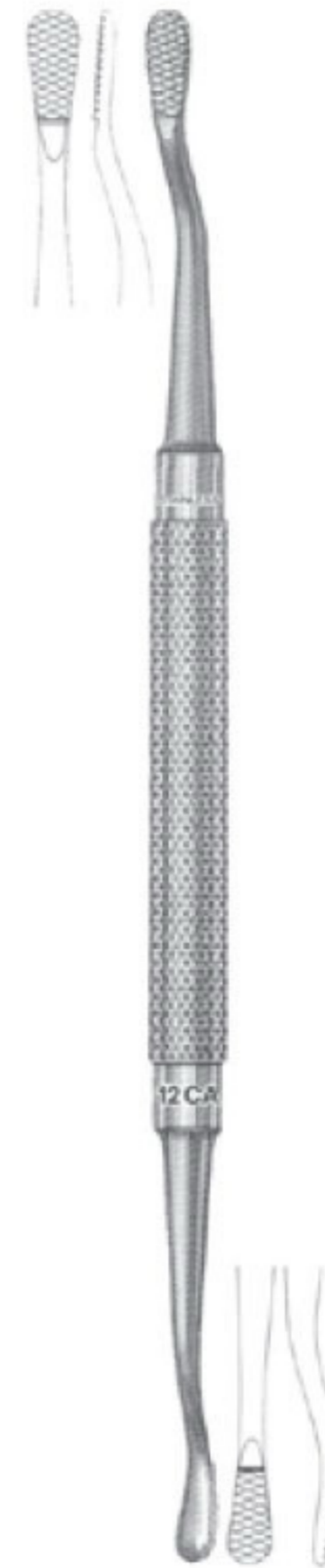

HOWARD No. 12CA
MWD-2132
 HOWARD No. 12CA

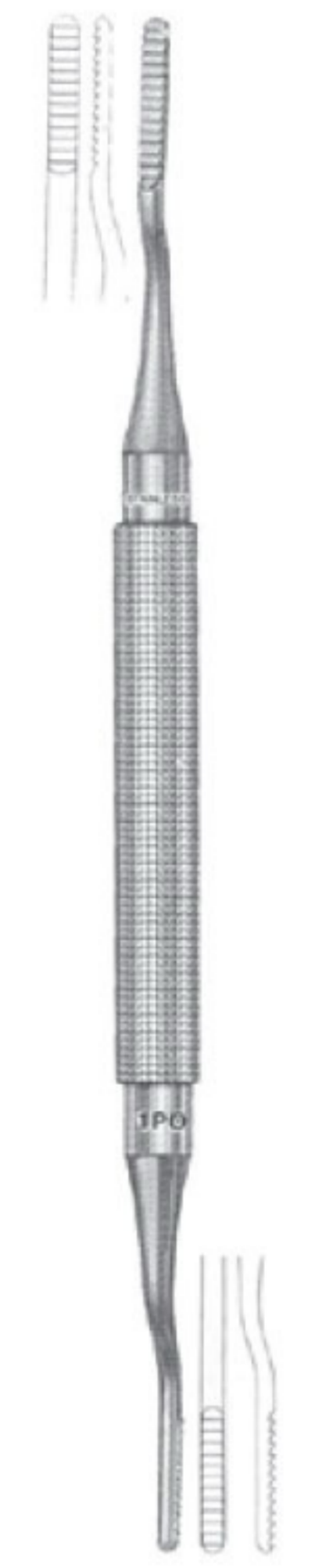

POLOKOFF No. 1
MWD-2133
 POLOKOFF No. 1



GARDNER No. 1
MWD-2134
GARDNER No. 1



GARDNER No. 2
MWD-2135
GARDNER No. 2



GARDNER No. 5
MWD-2136
GARDNER No. 5



GARDNER No. 5R
MWD-2137
GARDNER No. 5R



WAKEFIELD No. 1W
MWD-2138
WAKEFIELD No. 1W



WAKEFIELD No. 2W
MWD-2139
WAKEFIELD No. 2W



3 mm
MWD-2140
3 mm



4 mm
MWD-2141
4 mm



5 mm
MWD-2142
5 mm



6 mm
MWD-2143
6 mm



3 mm
MWD-2144
3 mm



4 mm
MWD-2145
4 mm



5 mm
MWD-2146
5 mm



6 mm
MWD-2147
6 mm



3 mm
MWD-2148
3 mm



4 mm
MWD-2149
4 mm



5 mm
MWD-2150
5 mm



6 mm
MWD-2151
6 mm



3 mm
MWD-2152
3 mm



4 mm
MWD-2153
4 mm



5 mm
MWD-2154
5 mm



6 mm
MWD-2155
6 mm



PARTSCH 19 cm
MWD-2156
PARTSCH 19 cm



MEAD 19,5 cm
MWD-2157
MEAD 19,5 cm



MEAD 17 cm
MWD-2158
MEAD 17 cm



MWD-2159



MWD-2160



MWD-2161



MWD-2162



Crown Spreader, Crown Remove. Special instrument for crown spreading after separating, simple and safe operation.

MWD-2163

Crown Spreader, Crown Remove. Special instrument for crown spreading after separating, simple and safe operation.



MWD-2164



MWD-2165



MWD-2166



MWD-2167

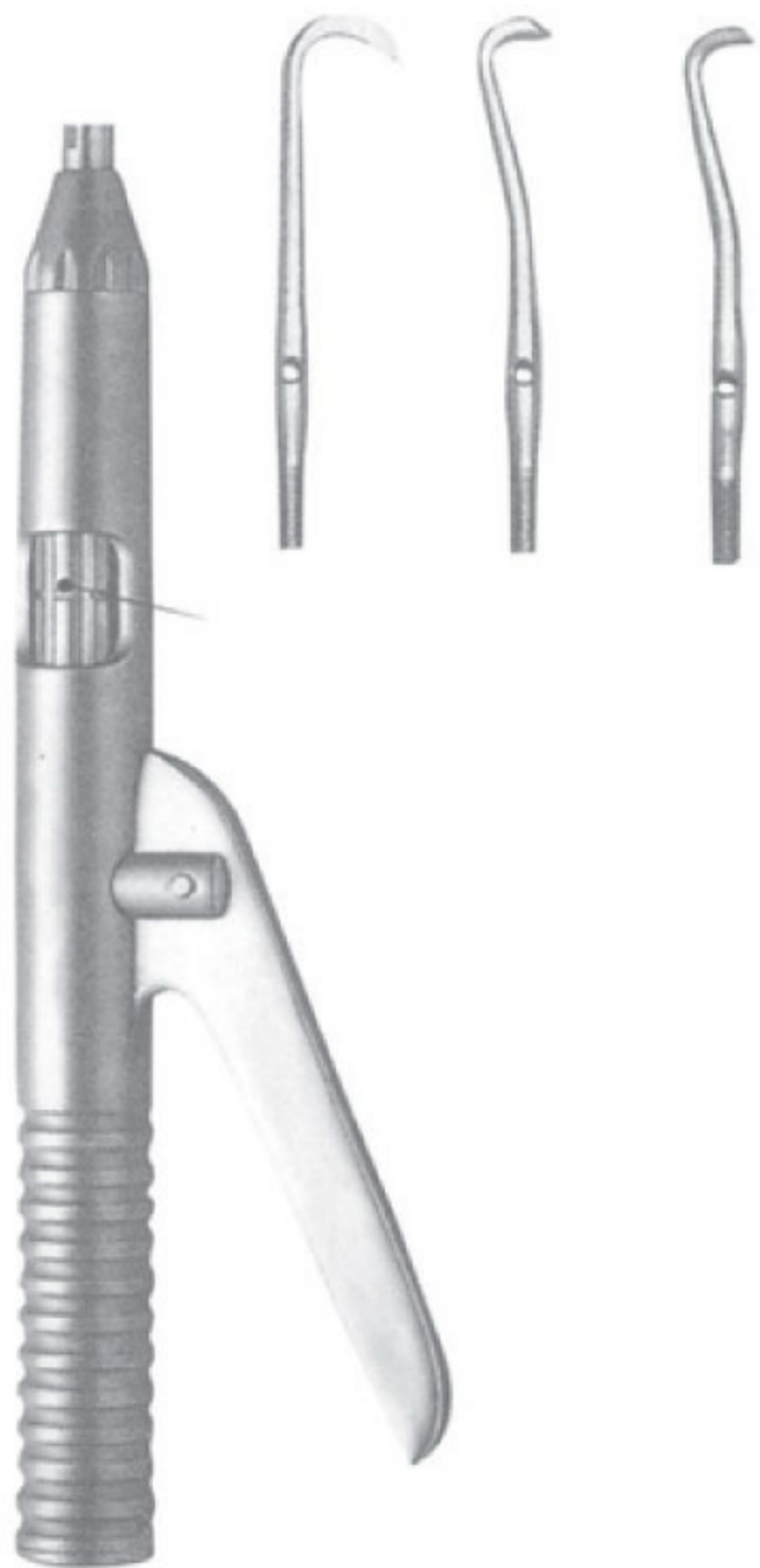

**Crown Remover
MWD-2168
Crown Remover**



**Crown Remover
MWD-2169
Crown Remover**



**single loop with adapter
MWD-2170
single loop with adapter**



KEY/9
MWD-2171
KEY/9



ADAPTER/8
MWD-2172
ADAPTER/8



Crown & Bridge Holding Forceps With Support Ring
MWD-2173
Crown & Bridge Holding Forceps With Support Ring



WYNMAN Crown Gripper, CARB-N-SERT
MWD-2174
WYNMAN Crown Gripper, CARB-N-SERT

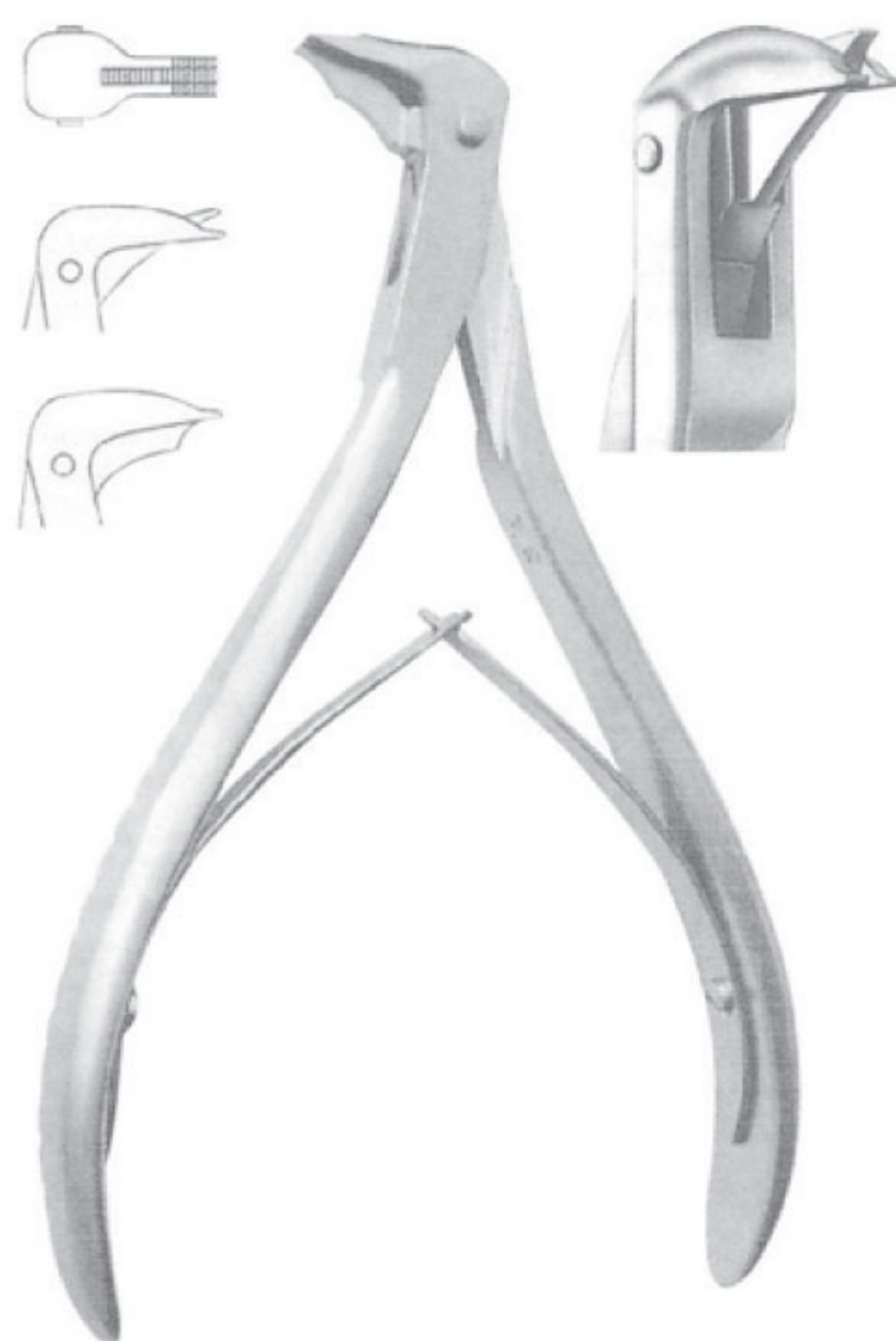

Crown opener
MWD-2175
Crown opener



Universal Hollow Handle
MWD-2176
Universal Hollow Handle



Fig.2
MWD-2177
Fig.2



Fig.3
MWD-2178
Fig.3

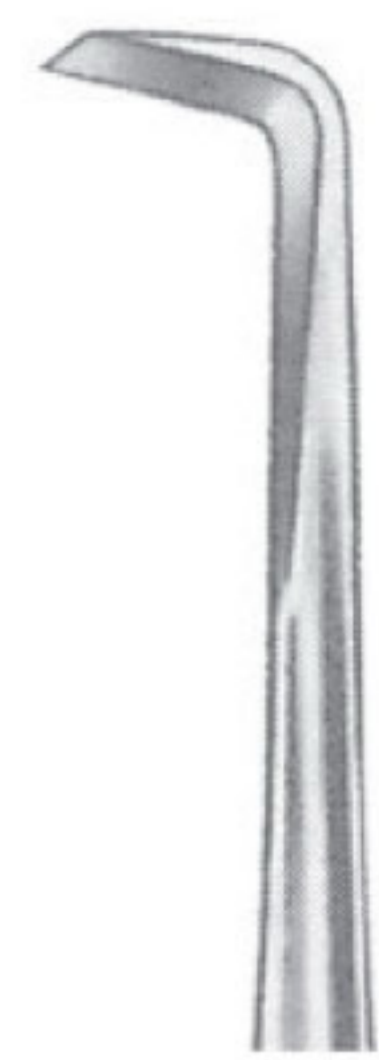

Fig.4
MWD-2179
Fig.4



Plaster Shear 210 mm
MWD-2180
Plaster Shear 210 mm



BOHM 16 cm
MWD-2181
BOHM 16 cm



Crown Removing Plier 14 cm
MWD-2182
Crown Removing Plier 14 cm



MONTFORT 18 CM
MWD-2183
MONTFORT 18 CM

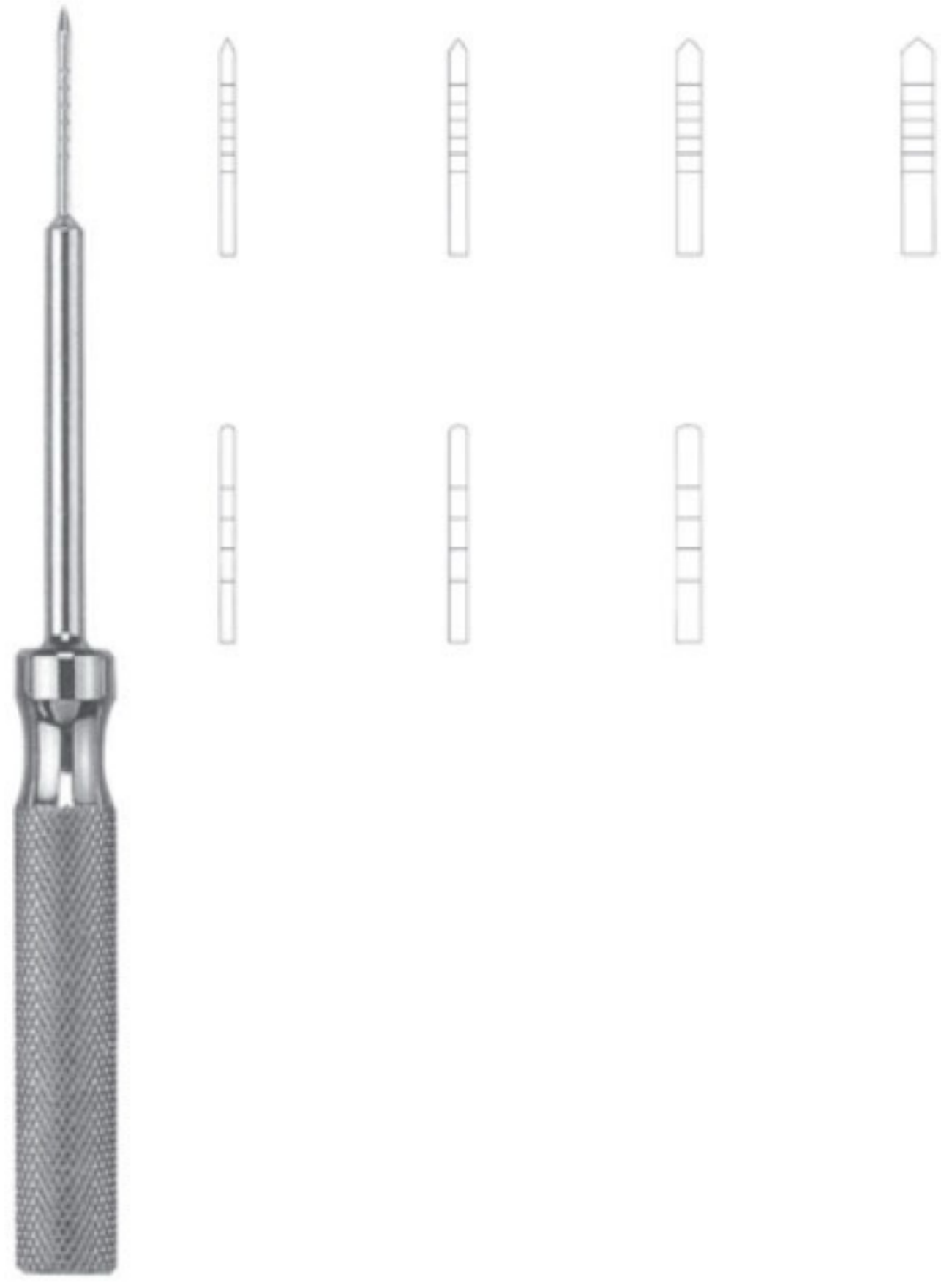

1P 150 mm
MWD-2184
 1P 150 mm

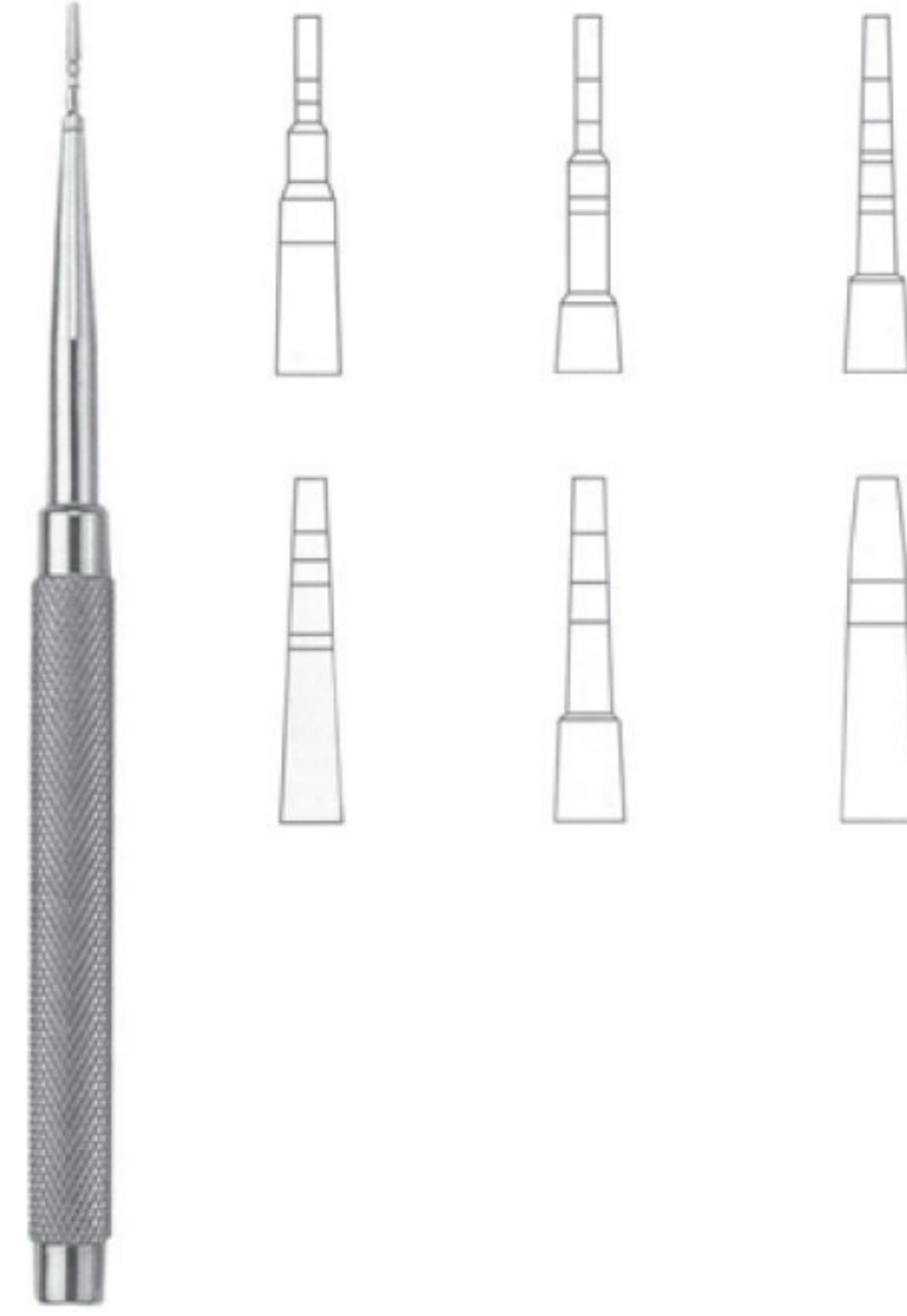

Fig. 1 155 mm
MWD-2185
 Fig. 1 155 mm

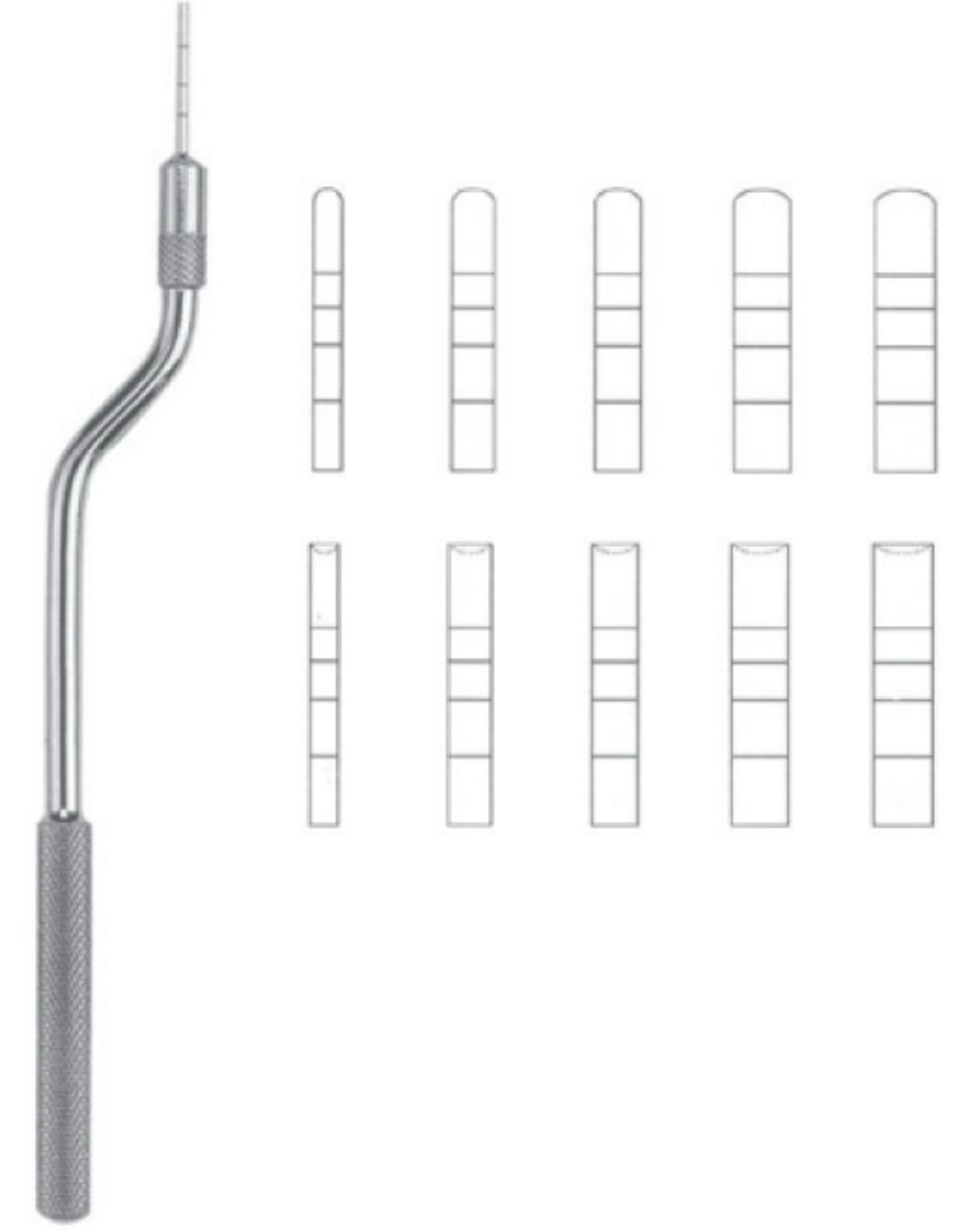

Fig. 1B 165 mm
MWD-2186
 Fig. 1B 165 mm

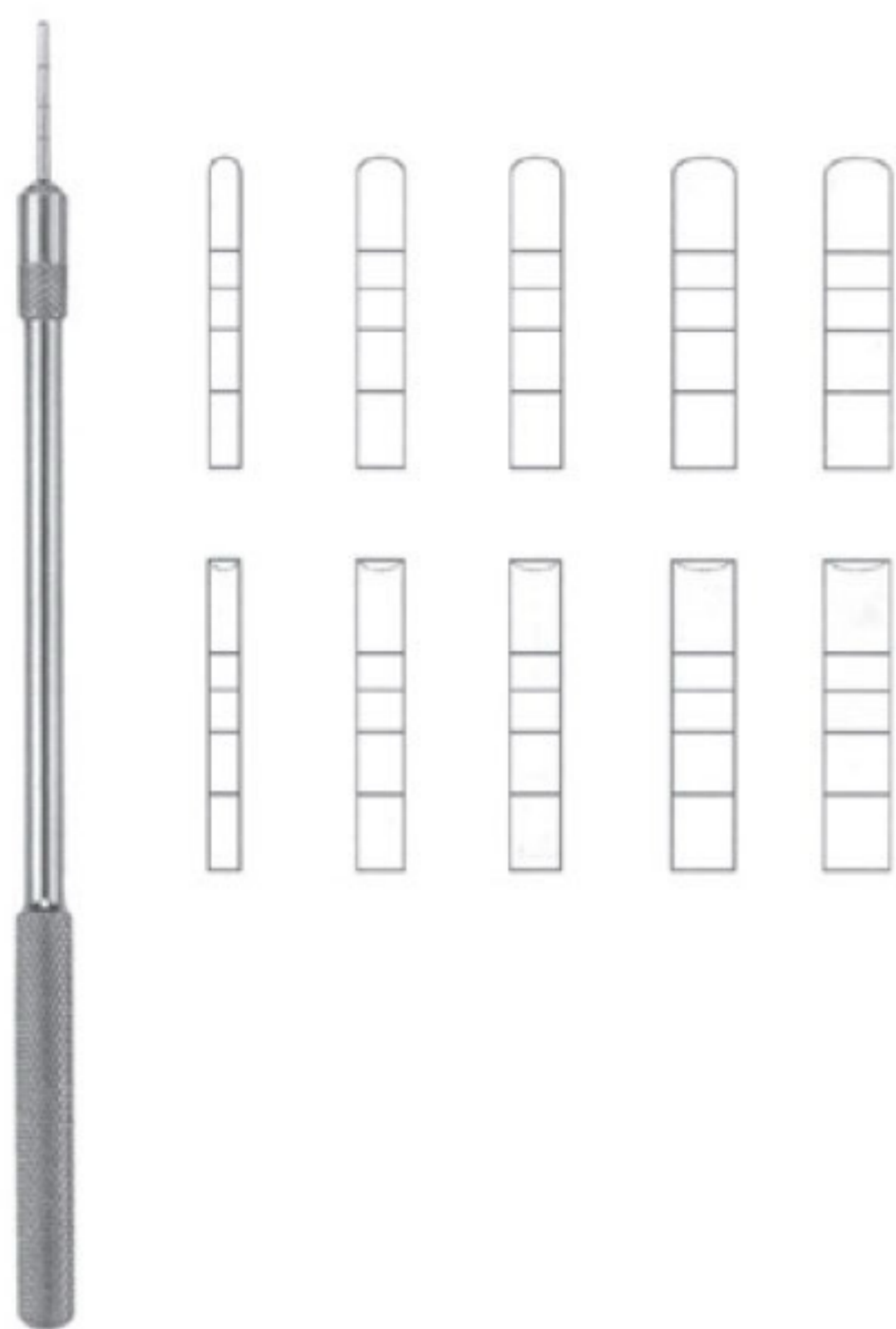
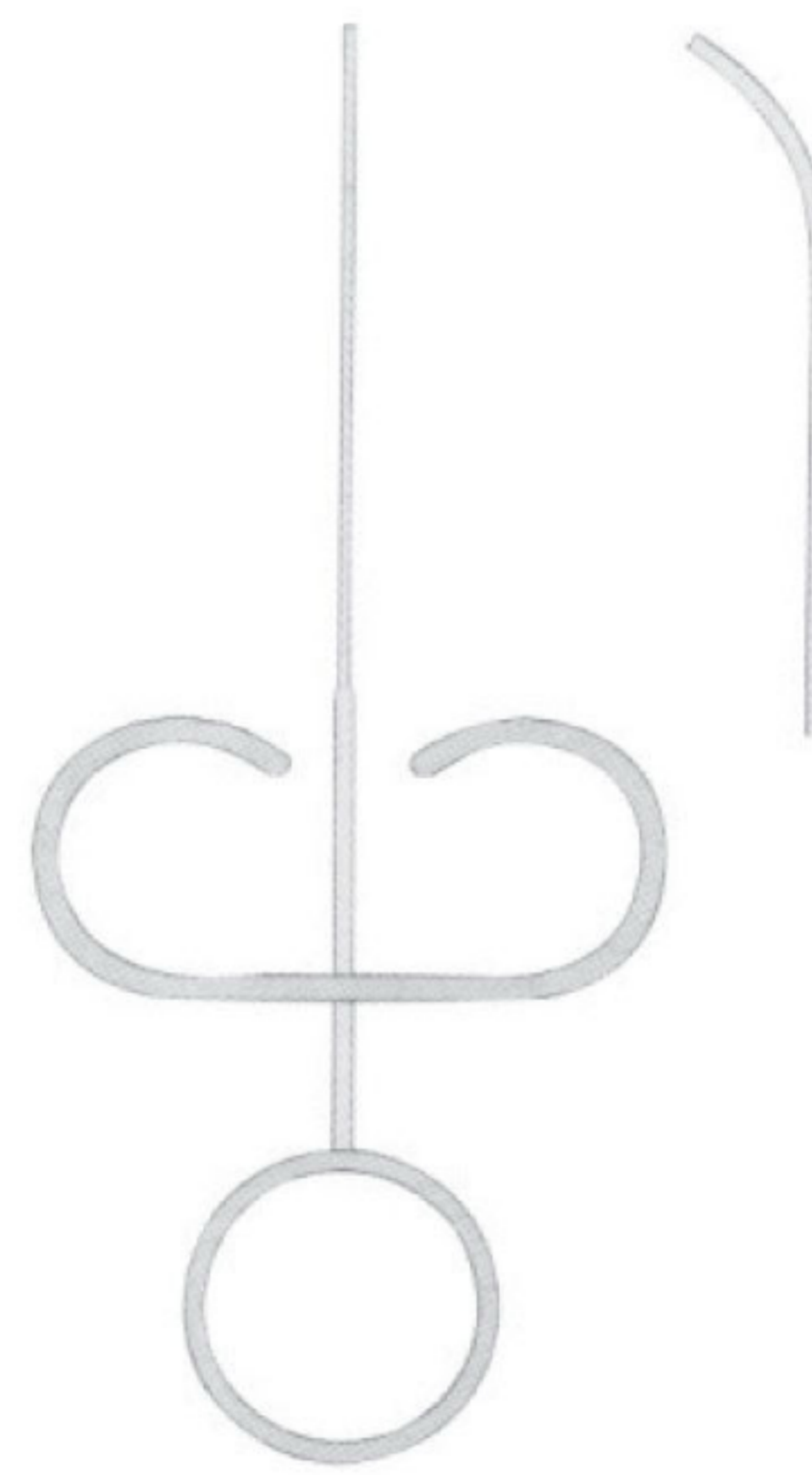
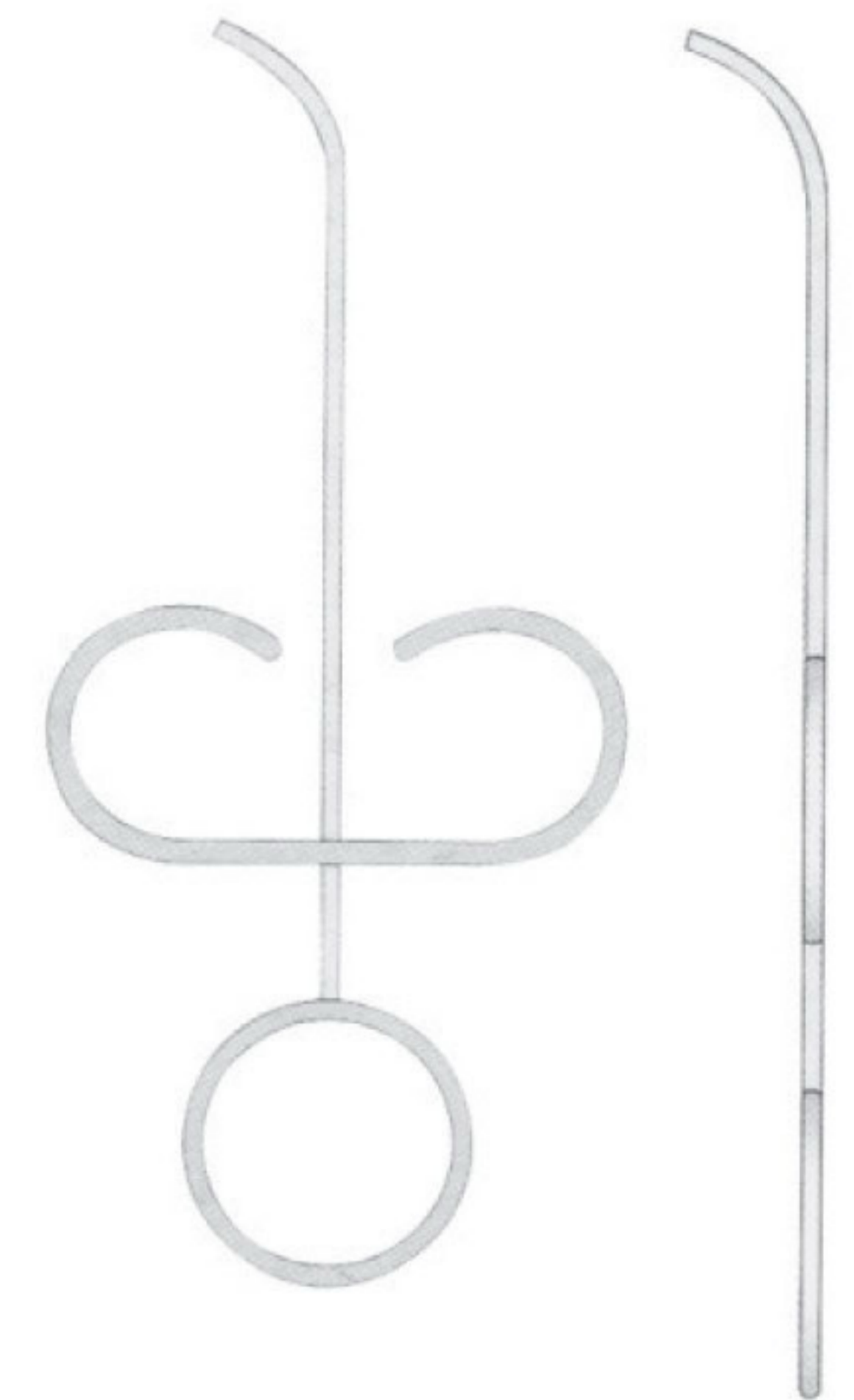

Fig. 1 155 mm
MWD-2187
 Fig. 1 155 mm



130 mm
MWD-2188
 130 mm



1.8 mm 130 mm
MWD-2189
 1.8 mm 130 mm



150 mm
MWD-2190
150 mm



150 mm
MWD-2191
150 mm



150 mm
MWD-2192
150 mm



2.5 150 mm
MWD-2193
2.5 150 mm



4.4 150 mm
MWD-2194
4.4 150 mm



Grinders for autogenous
MWD-2195
Grinders for autogenous



35 mm
MWD-2196
35 mm



Fig. 1 170 mm
MWD-2197
Fig. 1 170 mm



Fig. 2 175 mm
MWD-2198
Fig. 2 175 mm



Fig. 3 170 mm
MWD-2199
Fig. 3 170 mm



LUCAS Fig. 88 170 mm
MWD-2200
LUCAS Fig. 88 170 mm



MWD-2201



Fig. 2
MWD-2202
Fig. 2



3.5 mm
MWD-2203
3.5 mm



6 mm 5 mm
MWD-2204
6 mm 5 mm



8.5 mm 7.55 mm
MWD-2205
8.5 mm 7.55 mm



11 mm 10 mm
MWD-2206
11 mm 10 mm



Fig.1
MWD-2207
Fig.1



Fig.2
MWD-2208
Fig.2



Fig.3
MWD-2209
Fig.3



Fig.4
MWD-2210
Fig.4



Fig.5
MWD-2211
Fig.5



Fig.6
MWD-2212
Fig.6



Fig.7
MWD-2213
Fig.7



Fig.8
MWD-2214
Fig.8



Fig.9
MWD-2215
Fig.9

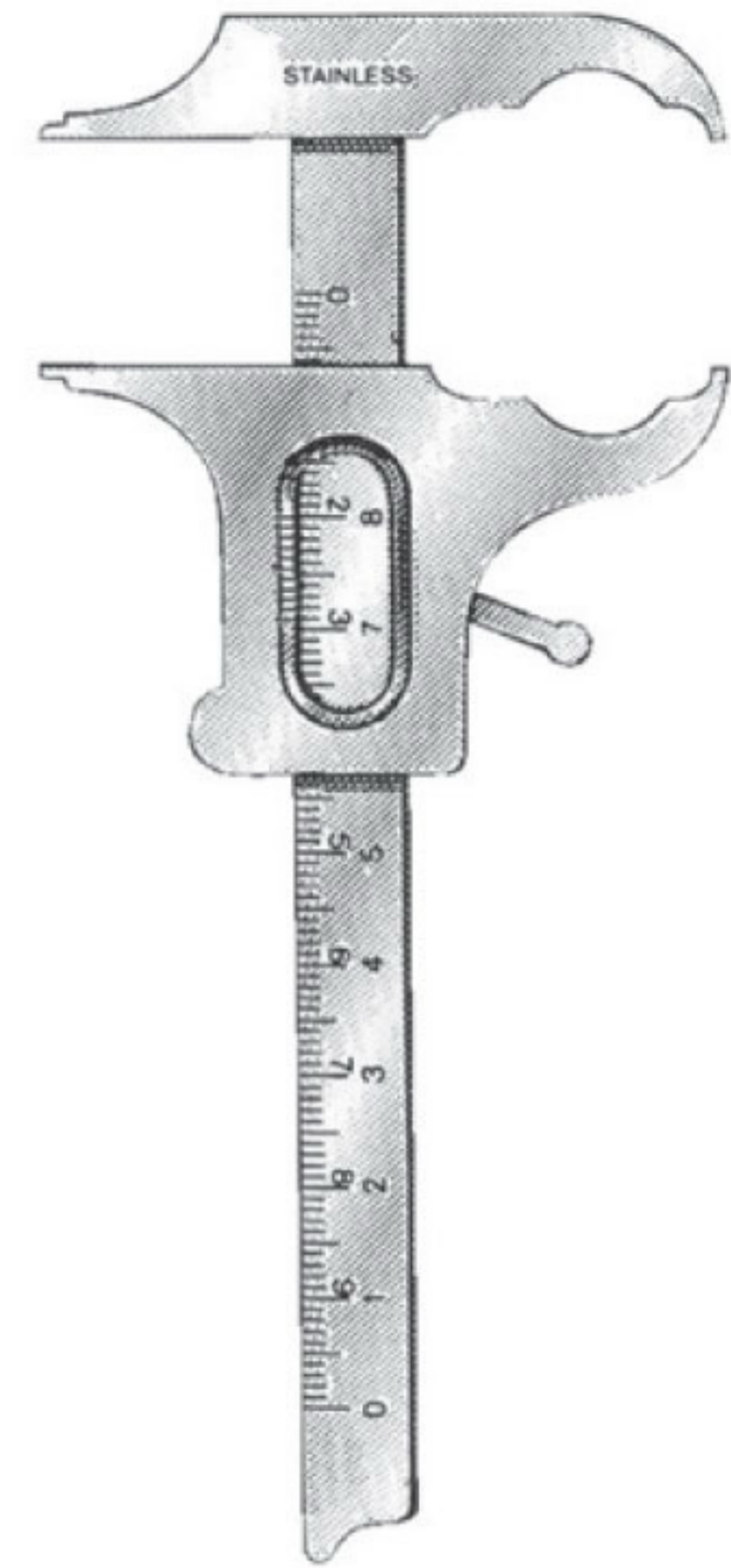

BOLEY Gauge
MWD-2216
BOLEY Gauge



ZURICHER 130 mm
MWD-2217
ZURICHER 130 mm



VERNIER 12 cm
MWD-2218
VERNIER 12 cm



VERNIER
MWD-2219
VERNIER



Height Gauge Wick Type
MWD-2220
 Height Gauge Wick Type

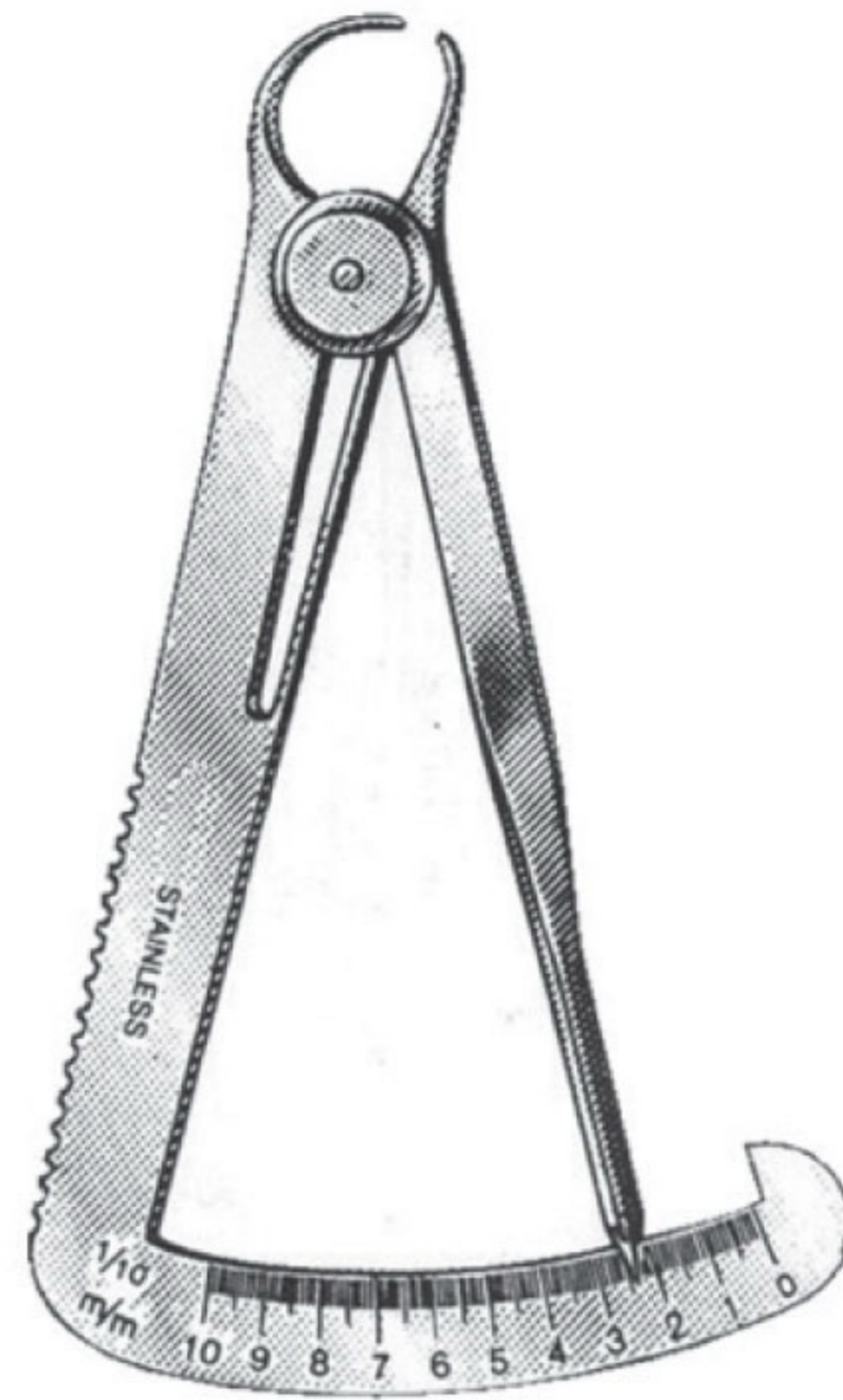

LWANSON Crown Gauge
MWD-2221
 LWANSON Crown Gauge



CASTROVIEJO'S Sclerer Marker
MWD-2222
 CASTROVIEJO'S Sclerer Marker



Spring Bow Divider 6" Radius
MWD-2223
 Spring Bow Divider 6" Radius

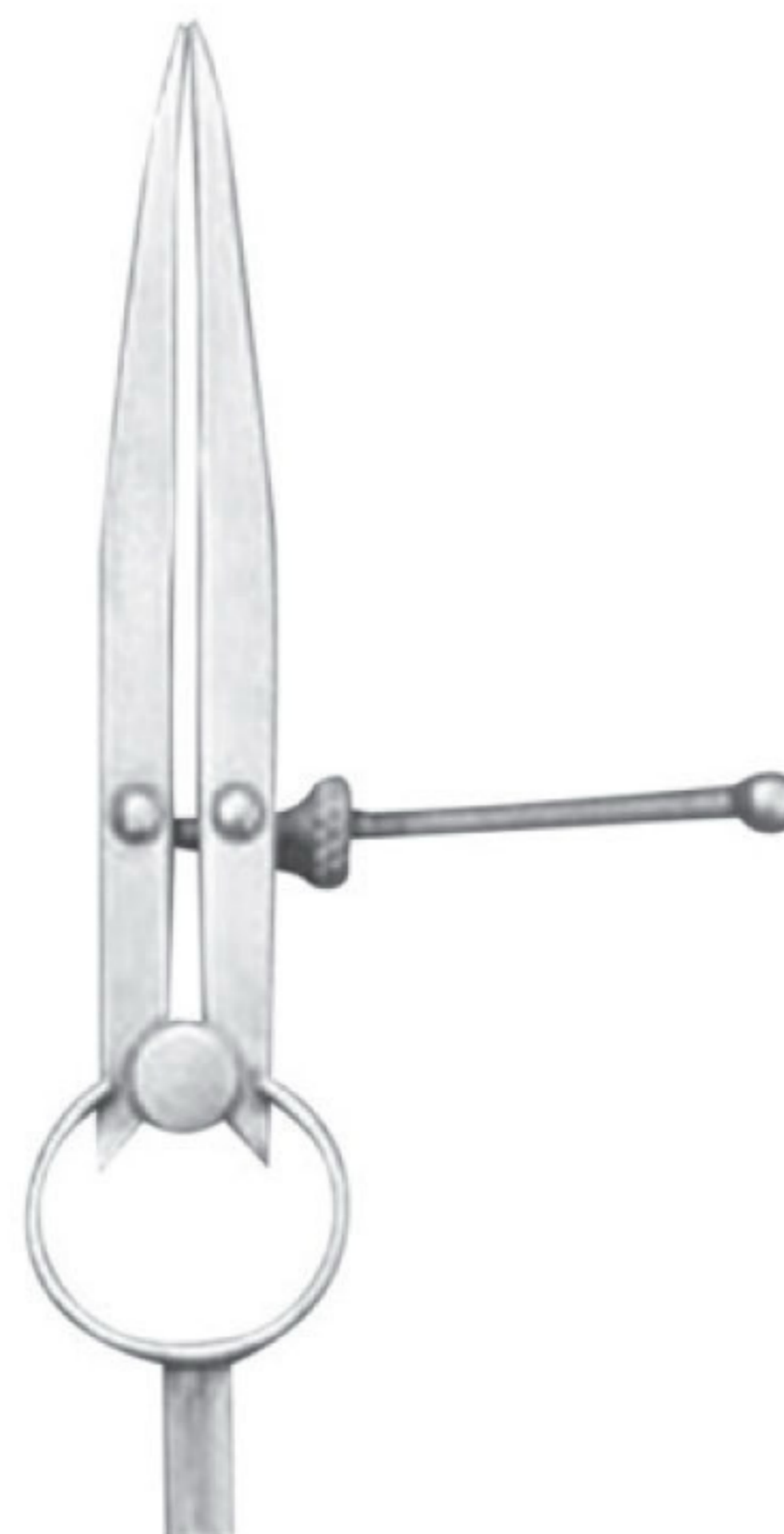

ALBEE
MWD-2224
 ALBEE

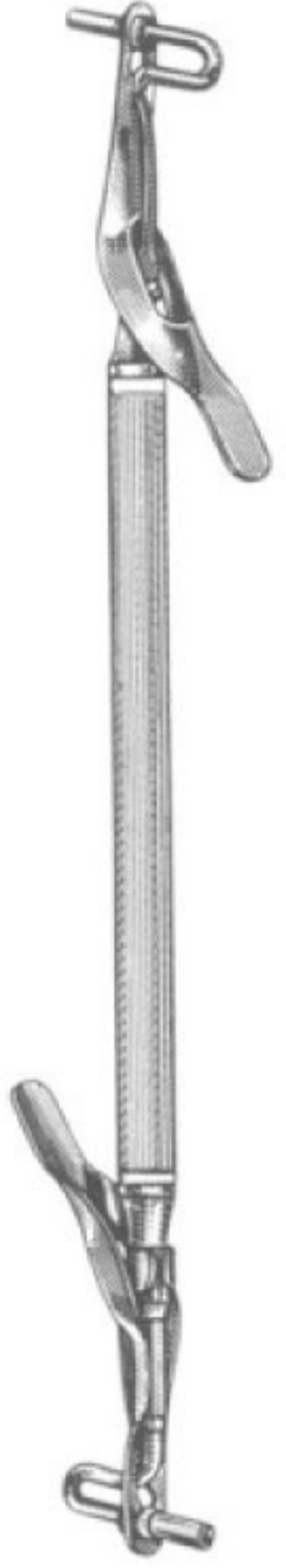

Medium-Large 20 cm
MWD-2225
Medium-Large 20 cm

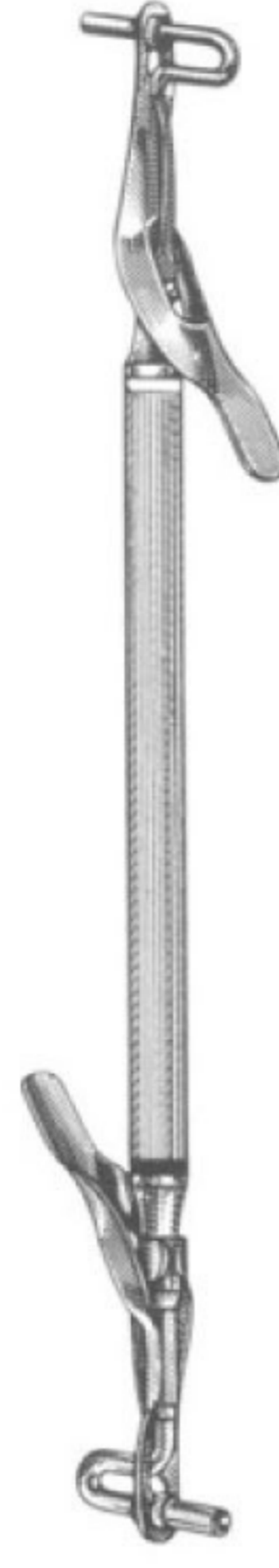

Medium-Jumbo 20 cm
MWD-2226
Medium-Jumbo 20 cm

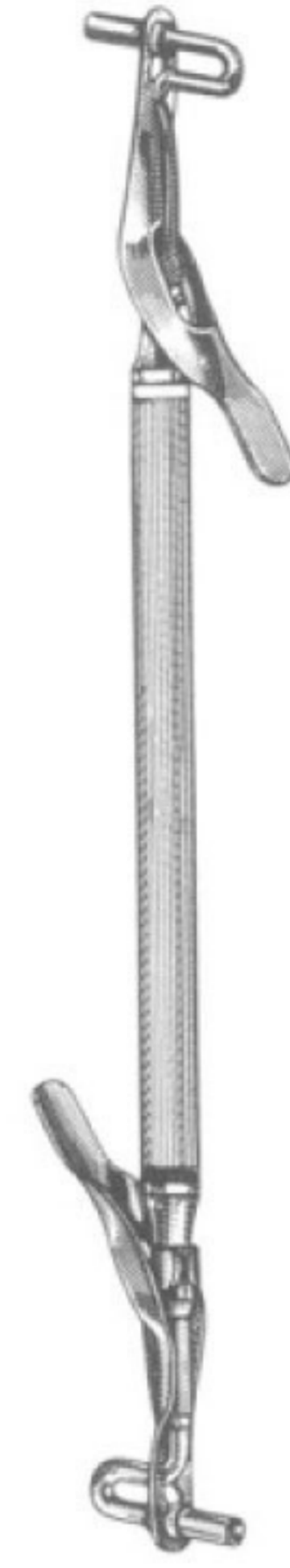

Large-Jumbo 20 cm
MWD-2227
Large-Jumbo 20 cm

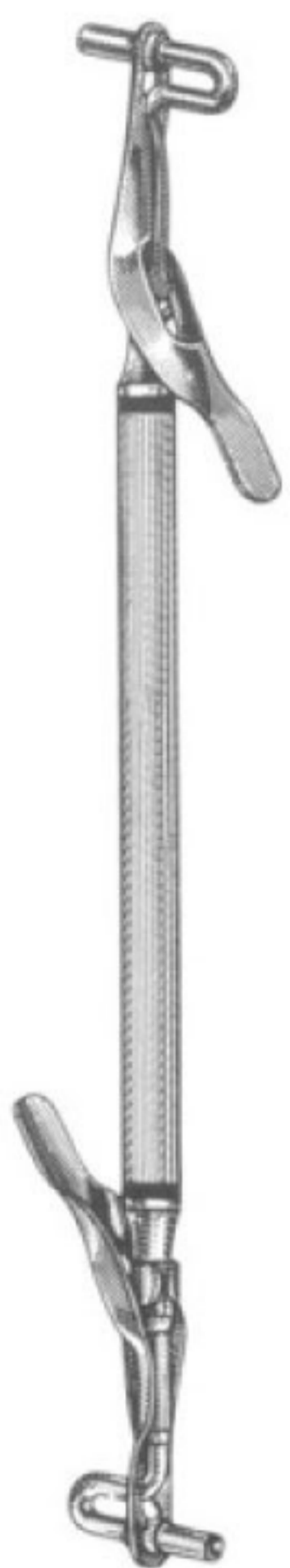

Jumbo-Jumbo 20 cm
MWD-2228
Jumbo-Jumbo 20 cm



Regular-Jumbo Silicon Grip 20 cm
MWD-2229
Regular-Jumbo Silicon Grip 20 cm

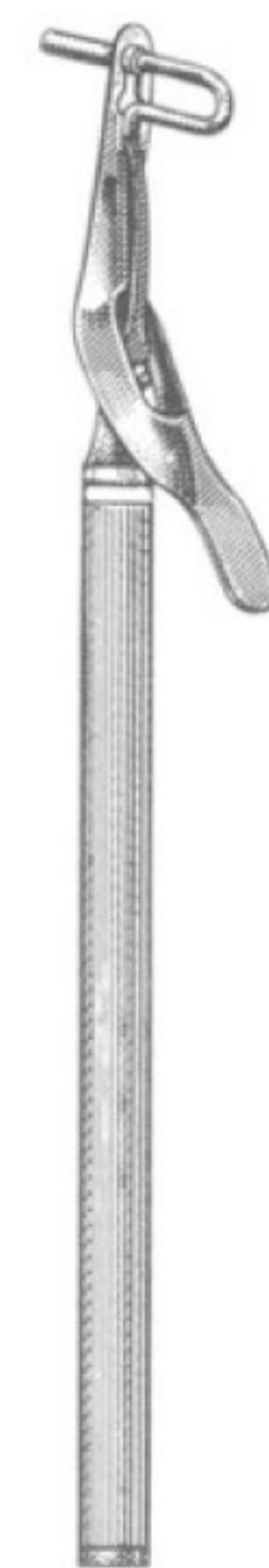

Medium 15.5 cm
MWD-2230
Medium 15.5 cm

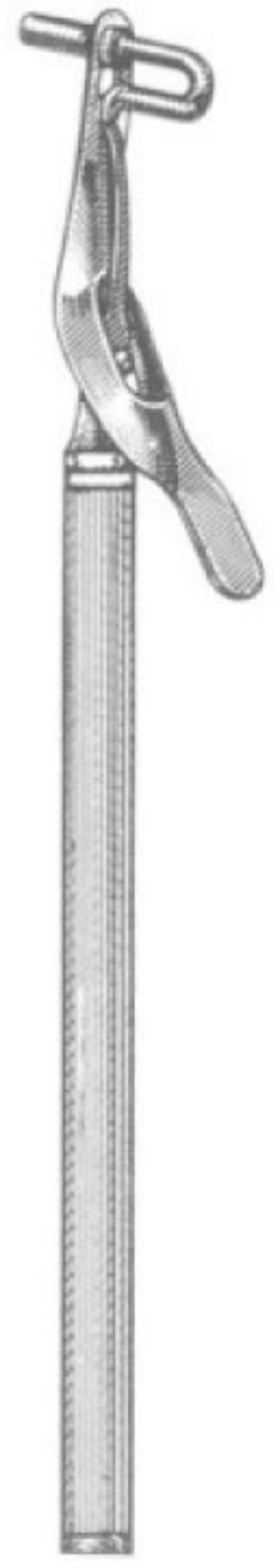

Large 15.5 cm
MWD-2231
Large 15.5 cm

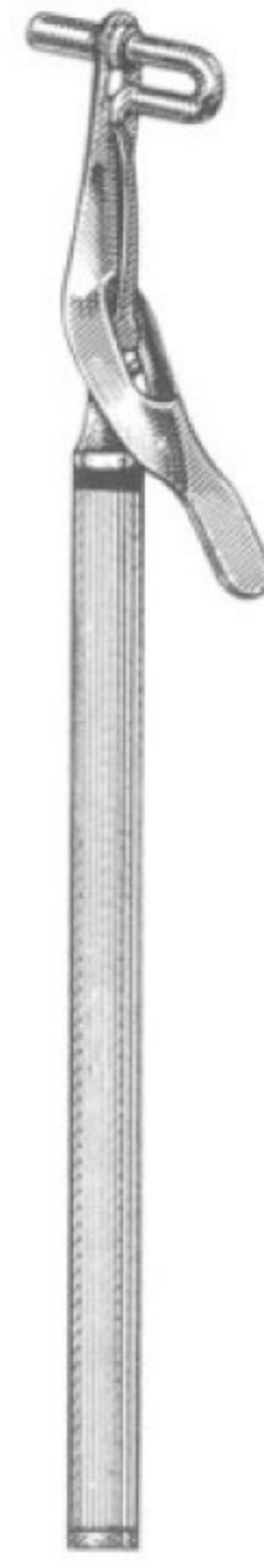

Jumbo 15.5 cm
MWD-2232
Jumbo 15.5 cm



145 mm
MWD-2233
145 mm



130 mm
MWD-2234
130 mm



Straight 15 cm
MWD-2235
Straight 15 cm



15 cm
MWD-2236
15 cm

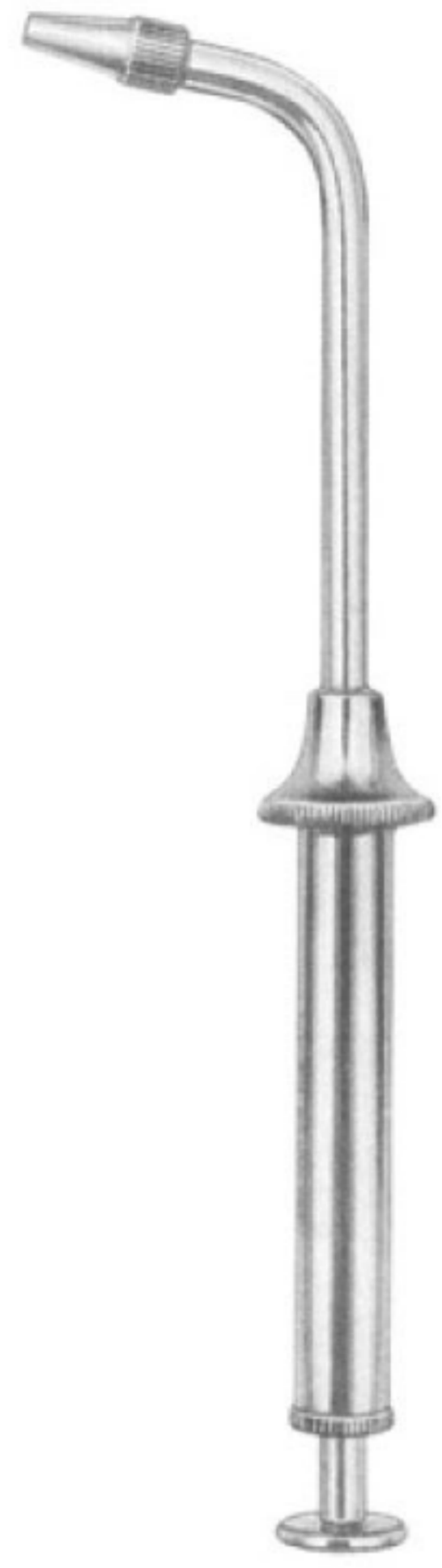

15 cm 90
MWD-2237
15 cm 90



Amalgam Well Non Skid Base
MWD-2238
Amalgam Well Non Skid Base



No. 1
MWD-2239
No. 1



No. 8
MWD-2240
No. 8



No. 9
MWD-2241
No. 9

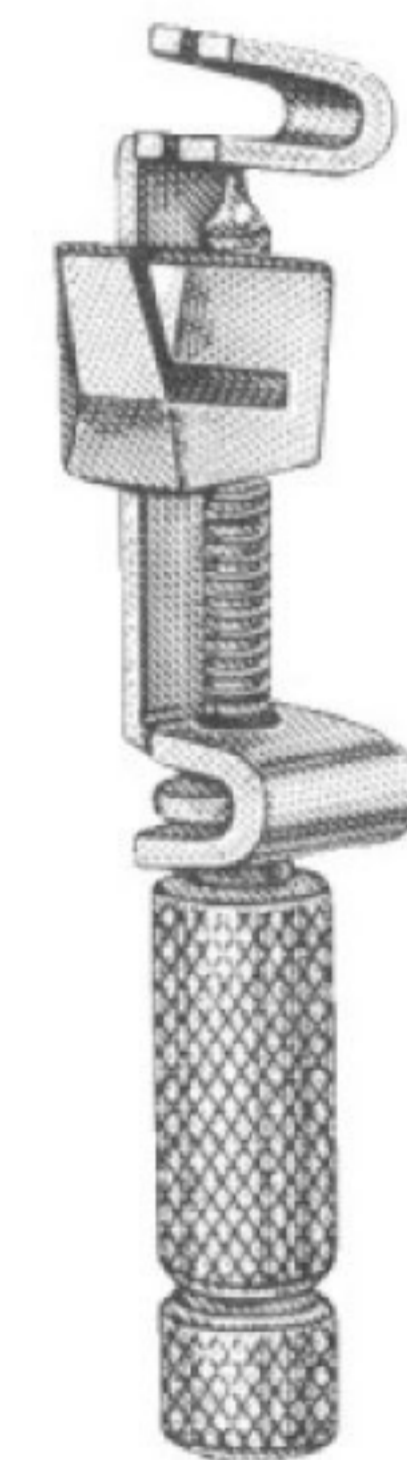

JUNIOR-CA
MWD-2242
JUNIOR-CA



SENIOR-CA
MWD-2243
 SENIOR-CA

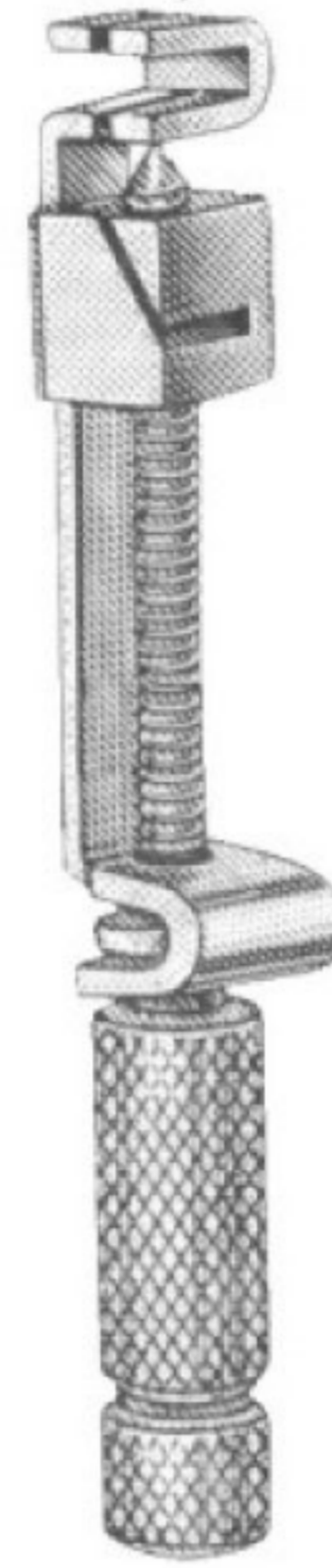

UNIVERSAL
MWD-2244
 UNIVERSAL



.0015", .002"
MWD-2245
 .0015", .002"

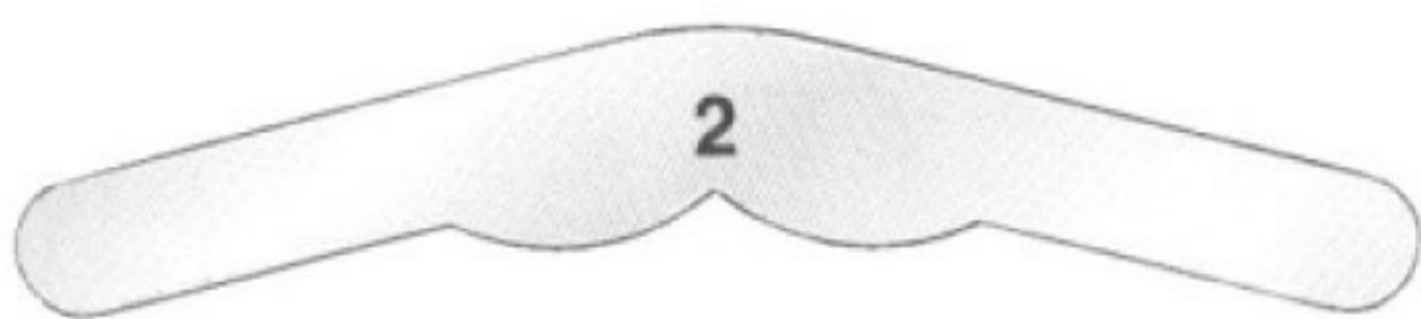

.0015", .002"
MWD-2246
 .0015", .002"

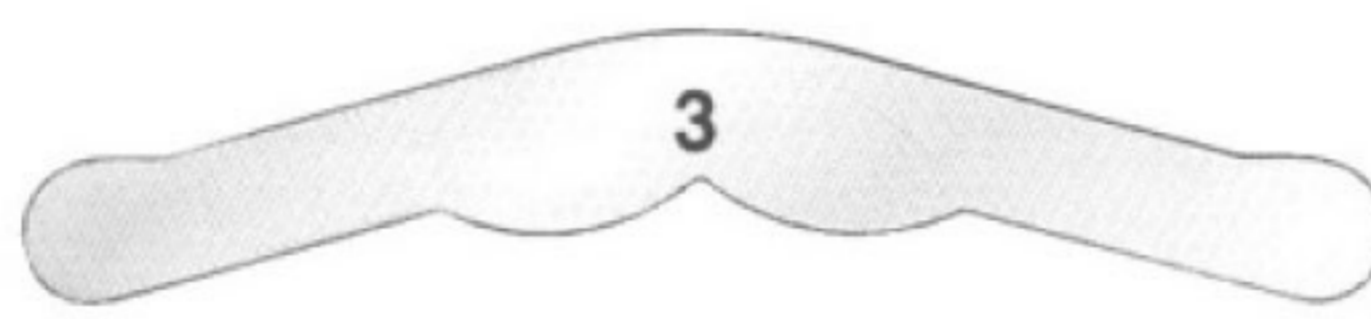

.0015", .002"
MWD-2247
 .0015", .002"

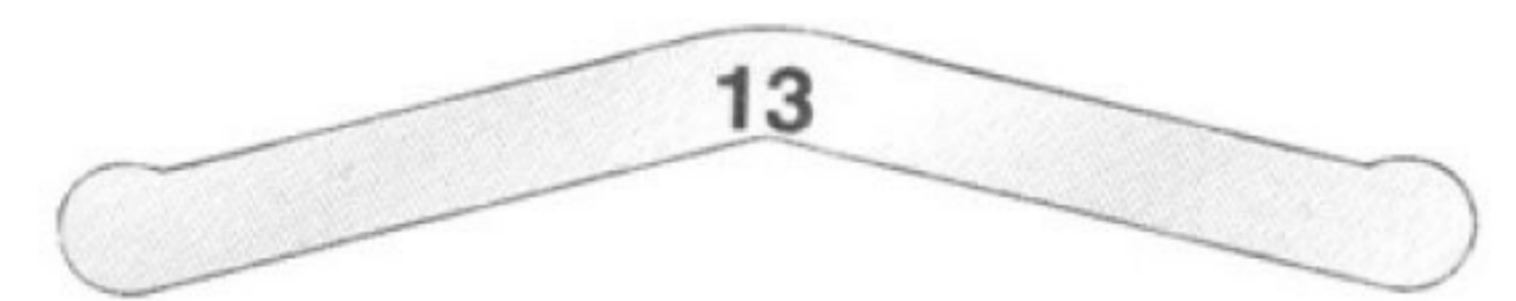

.0015", .002"
MWD-2248
 .0015", .002"



BALL CHAIN
MWD-2249
BALL CHAIN



NON-CHILL Clear Plastic
MWD-2250
NON-CHILL Clear Plastic

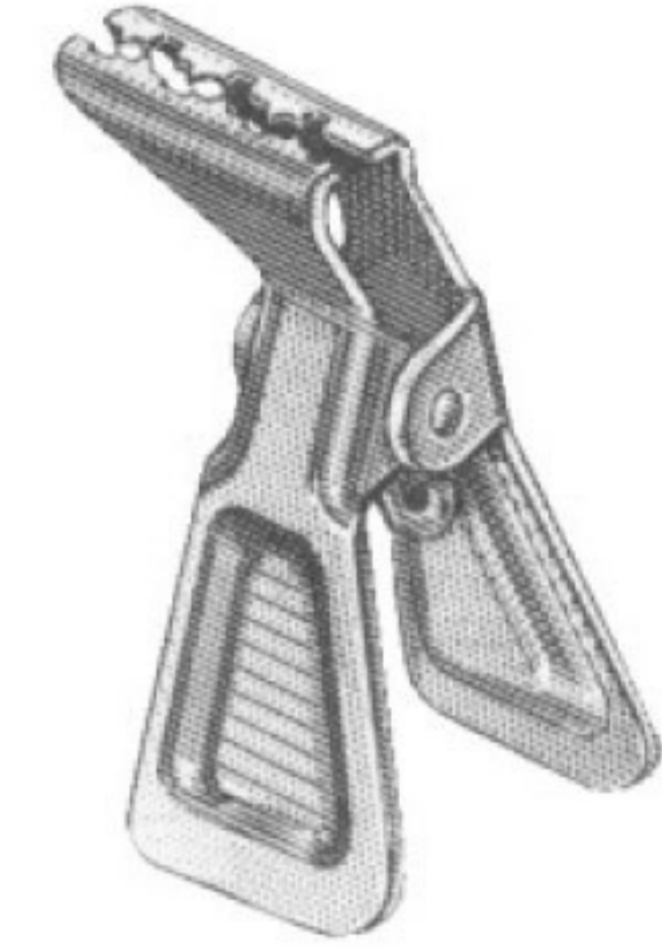

Strip Holder Clip 90
MWD-2251
Strip Holder Clip 90

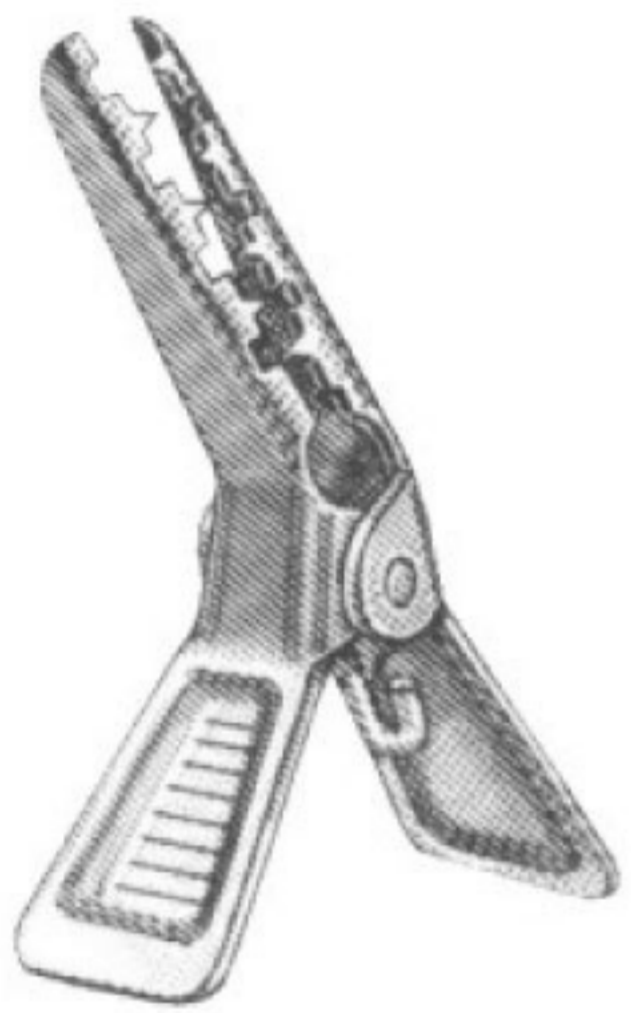

Strip Holder Clip 45
MWD-2252
Strip Holder Clip 45



IRORY Light weight, 170 mm
MWD-2253
 IRORY Light weight, 170 mm

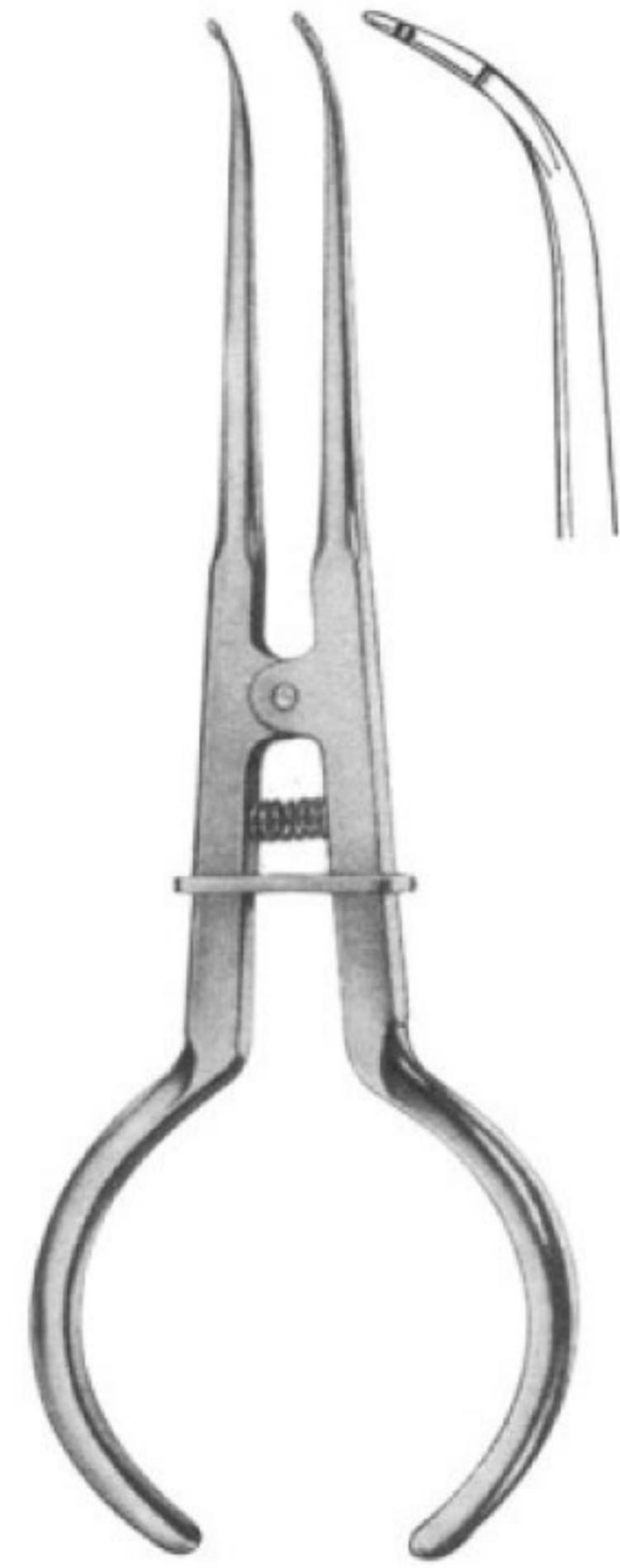

BREWER 175 mm
MWD-2254
 BREWER 175 mm

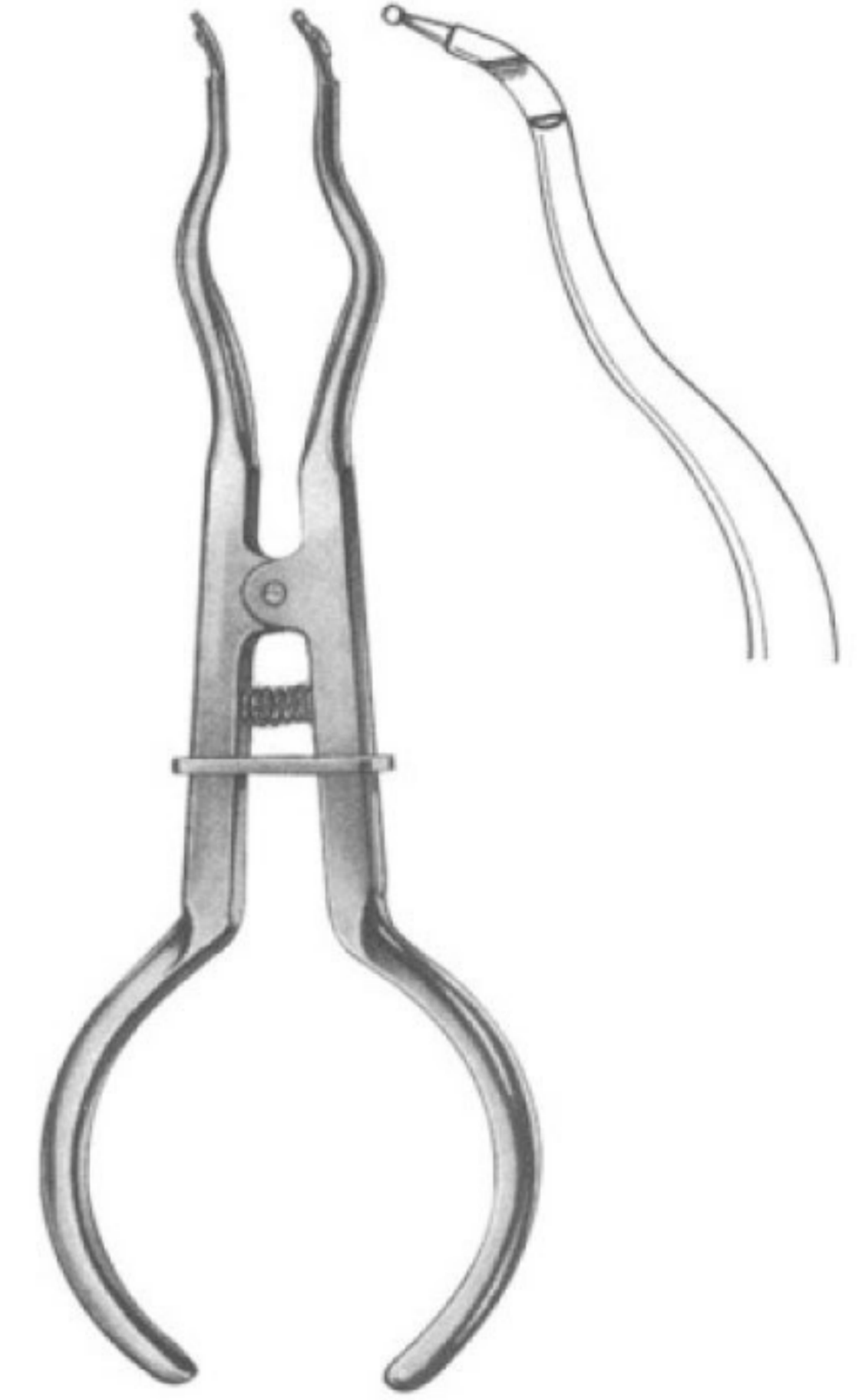

BREWER 175 mm
MWD-2255
 BREWER 175 mm



WHITE 175 mm
MWD-2256
 WHITE 175 mm



IVORY 170 mm
MWD-2257
 IVORY 170 mm



AINSWORTH Rubber Dam Punch 170 mm
MWD-2258
 AINSWORTH Rubber Dam Punch 170 mm



**AINSWORTH Ainsworth Rubber Dam
Punch 170 mm
MWD-2259**
AINSWORTH Ainsworth Rubber Dam Punch
170 mm



**AINSWORTH Rubber Dam Punch 170 mm
MWD-2260**
AINSWORTH Rubber Dam Punch 170 mm

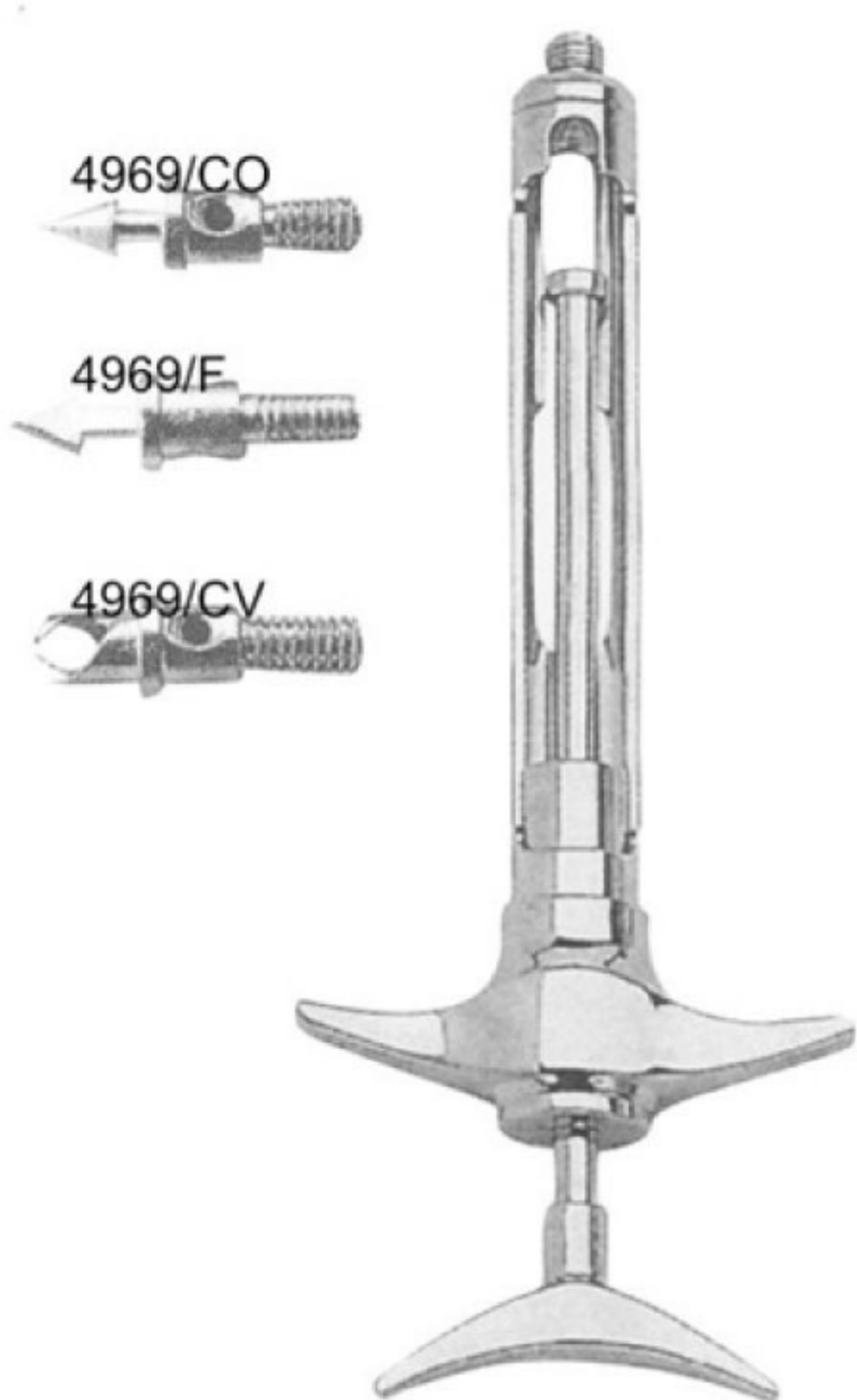

ml 1,8 EU
MWD-2303
ml 1,8 EU

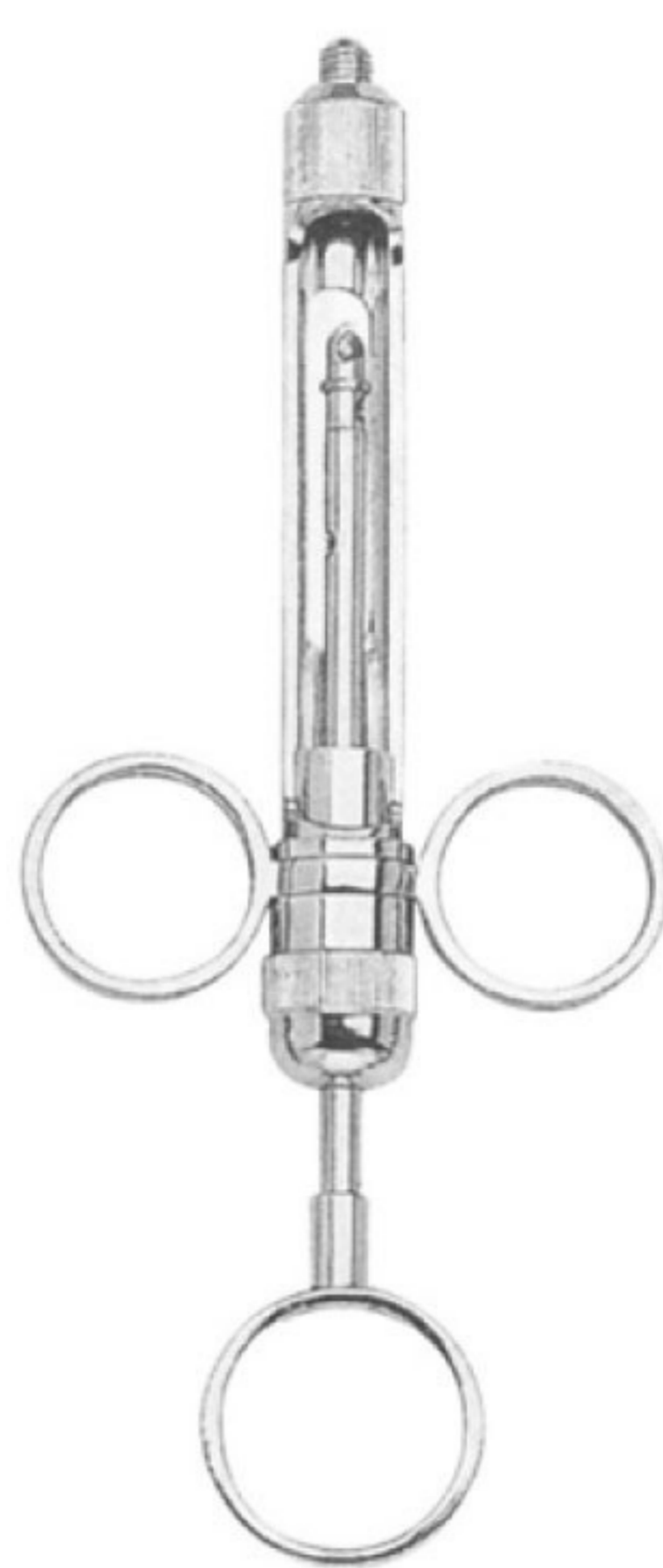

ml 1,8 EU/AM
MWD-2304
ml 1,8 EU/AM

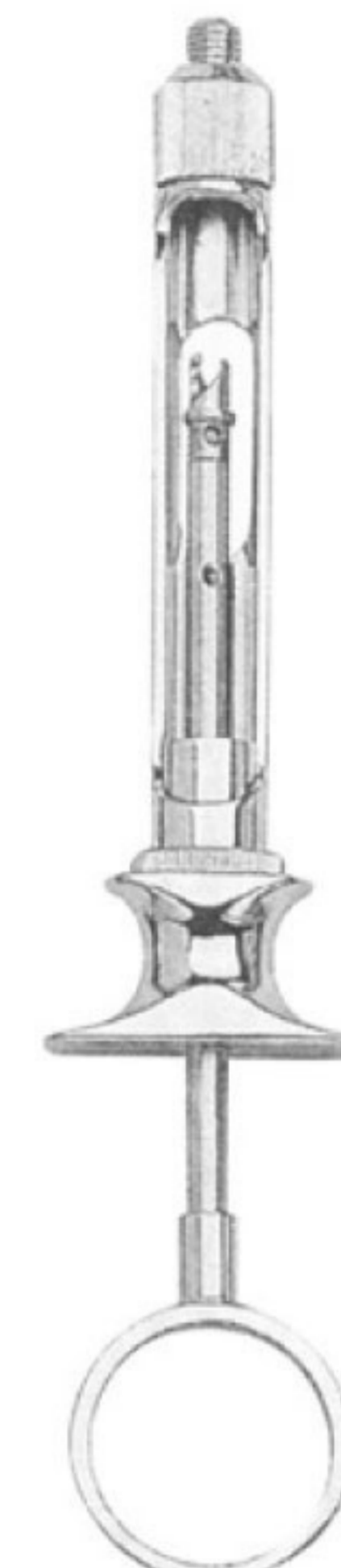

ml 1,8 EU/AM
MWD-2305
ml 1,8 EU/AM



Fig. 1 ml 1,8 EU
MWD-2306
Fig. 1 ml 1,8 EU



Fig. 1 ml 1,8 EU
MWD-2307
Fig. 1 ml 1,8 EU

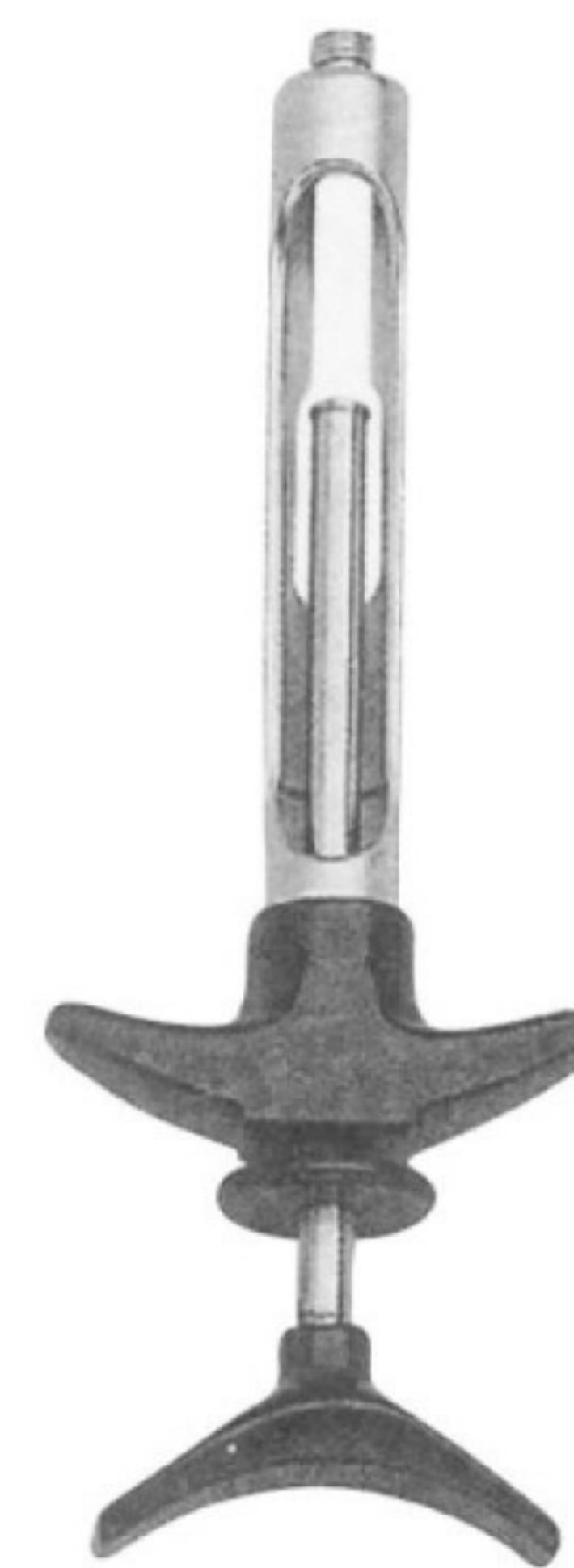

SS INOX All inox & autoclavable black plastic handle passive automatic aspiration.
MWD-2308

SS INOX All inox & autoclavable black plastic handle passive automatic aspiration.



Fig. 1 ml 1,8 EU/Am
MWD-2309
Fig. 1 ml 1,8 EU/Am



Fig. 1 ml 1,8 EU/Am
MWD-2310
ml 1,8 EU/Am



Fig. 1 ml 1,8 EU/Am
MWD-2311
Fig. 1 ml 1,8 EU/Am

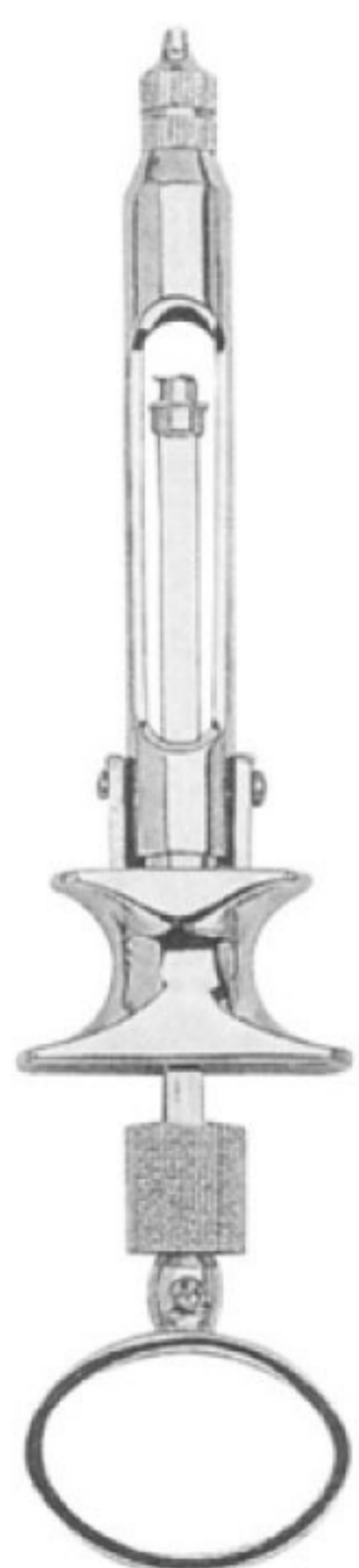

ml 1,2 EU/Am
MWD-2312
ml 1,2 EU/Am

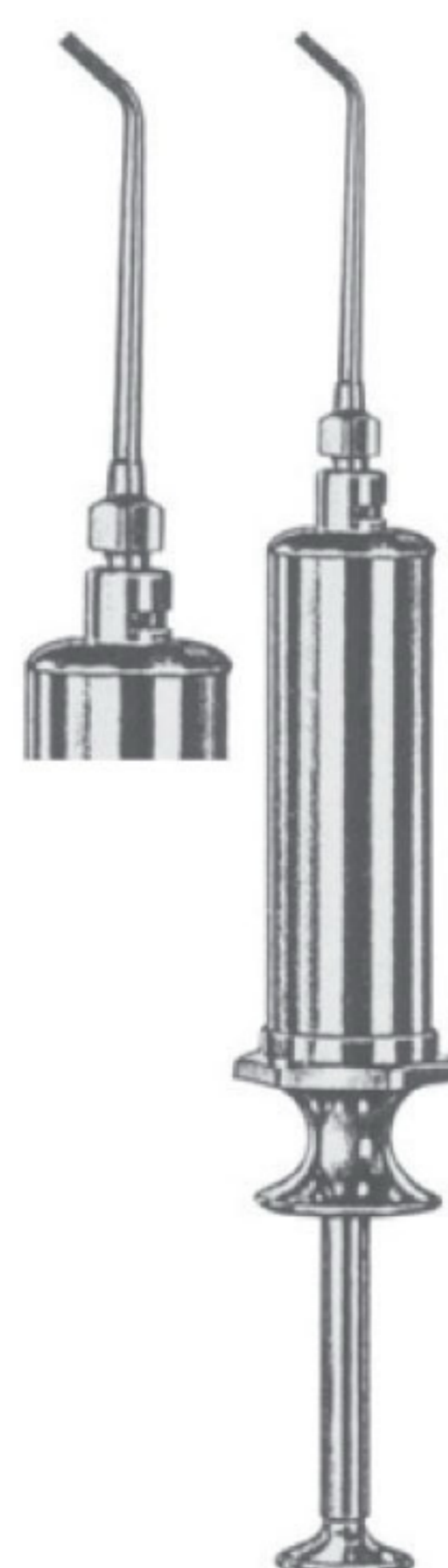

Water Syringe complete with 1 cannula
(Lure-Lock)
MWD-2313
Water Syringe complete with 1 cannula
(Lure-Lock)



Water Syringe complete with 1 cannula
(Lure-Lock)
MWD-2314
Water Syringe complete with 1 cannula
(Lure-Lock)



Metal Water Syringe self-filling, with1 cannula (Lure-Lock)

MWD-2315

Metal Water Syringe self-filling, with1 cannula (Lure-Lock)



Sparrel Barrel with plunger suitable for syringes

MWD-2316

Sparrel Barrel with plunger suitable for syringes



Cannula, only, with Luer-Lock connector suitable for syringes

MWD-2317

Cannula, only, with Luer-Lock connector suitable for syringes



Articulating Barrel Syringe

MWD-2318

Articulating Barrel Syringe



ml 1,8

MWD-2319

ml 1,8



ml 1,8

MWD-2320

ml 1,8



Fig. 1 ml 1,8
MWD-2321
Fig. 1 ml 1,8



Fig. 1 ml 1,8 EU
MWD-2322
Fig. 1 ml 1,8 EU



Fig. 1 ml 1,8 EU
MWD-2323
Fig. 1 ml 1,8 EU

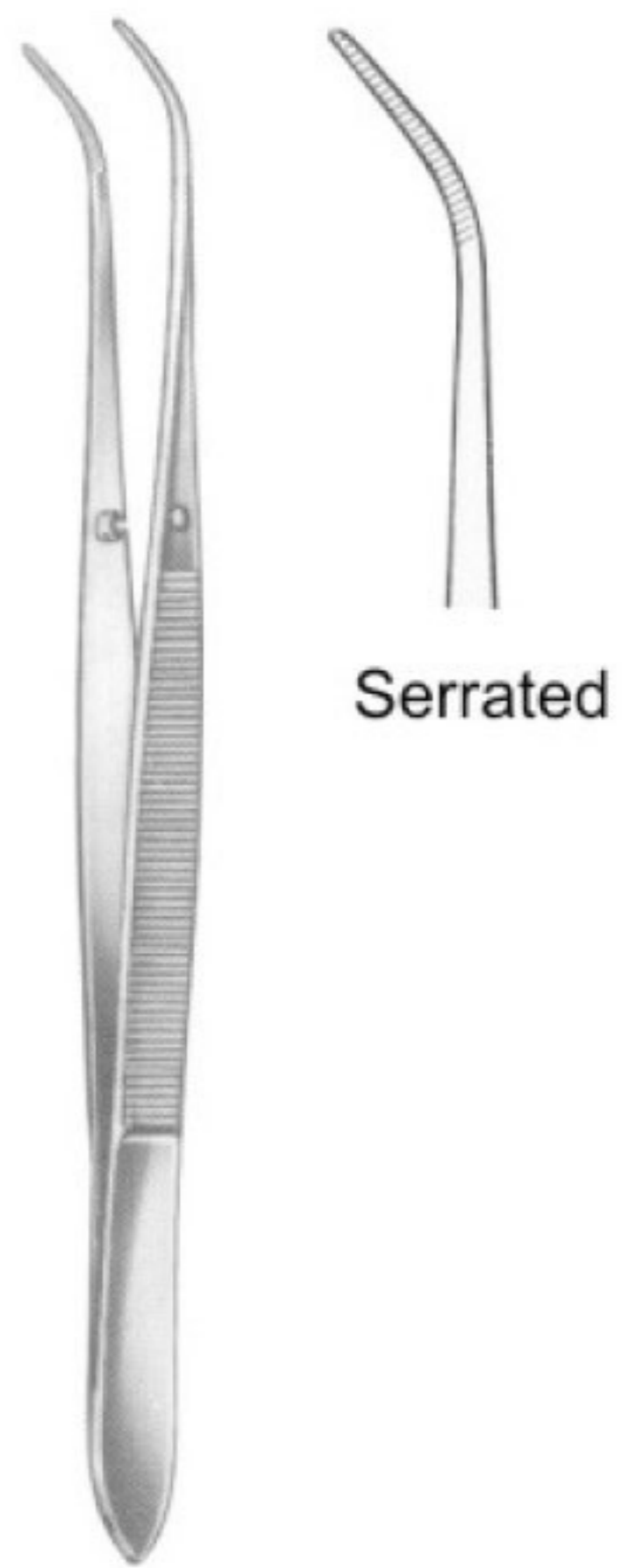

PERRY 13 cm
MWD-2324
PERRY 13 cm



ADSON 12 cm
MWD-2325
ADSON 12 cm



MICRO ADSON 15 cm
MWD-2326
MICRO ADSON 15 cm



STANDARD 14,18,25 cm
MWD-2327
 STANDARD 14,18,25 cm



CUSHING 18 cm
MWD-2328
 CUSHING 18 cm



Curved
MWD-2329
 Curved

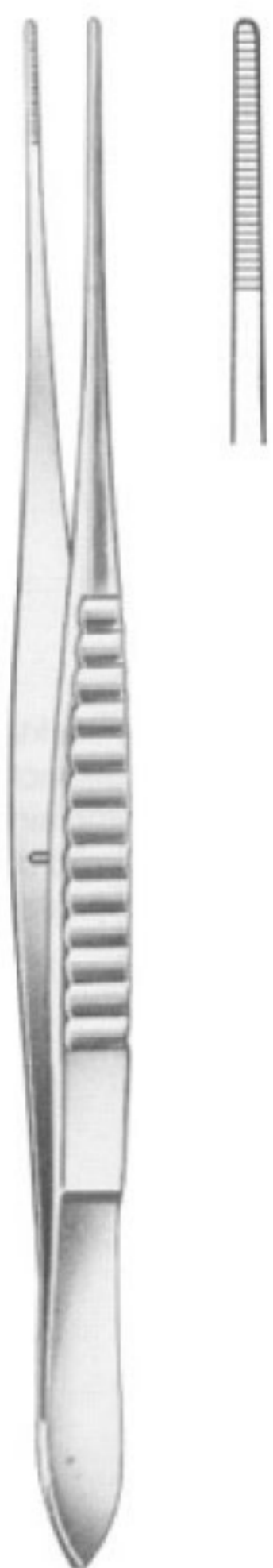

SELECT 15,18,20 cm
MWD-2330
 SELECT 15,18,20 cm

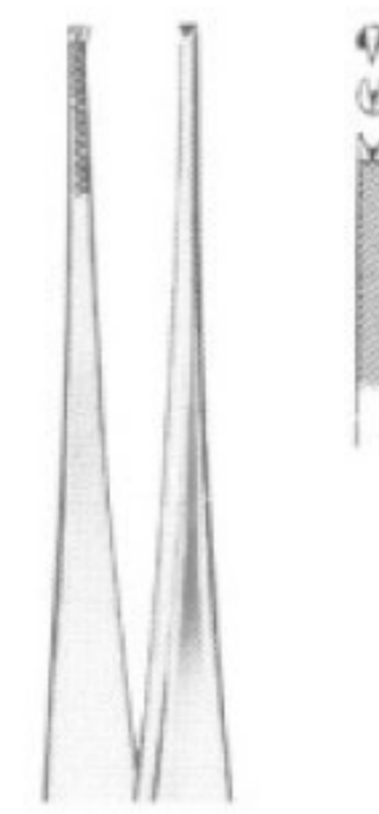

MWD-2331



MCINDOE 15 cm
MWD-2332
 MCINDOE 15 cm



GILLIES 15 cm
MWD-2333
 GILLIES 15 cm

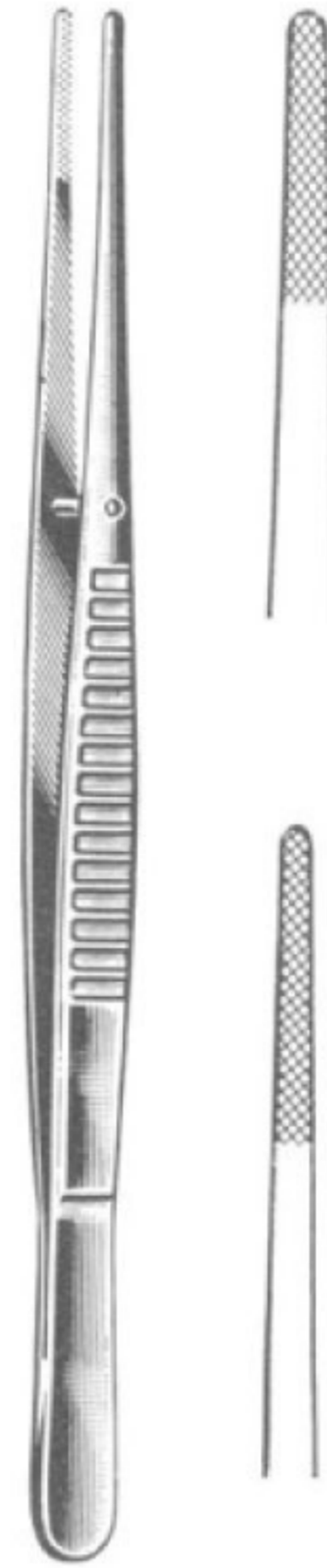

WAUGH 15,20 cm
MWD-2334
 WAUGH 15,20 cm



KOPP 15.5 cm
MWD-2335
 KOPP 15.5 cm

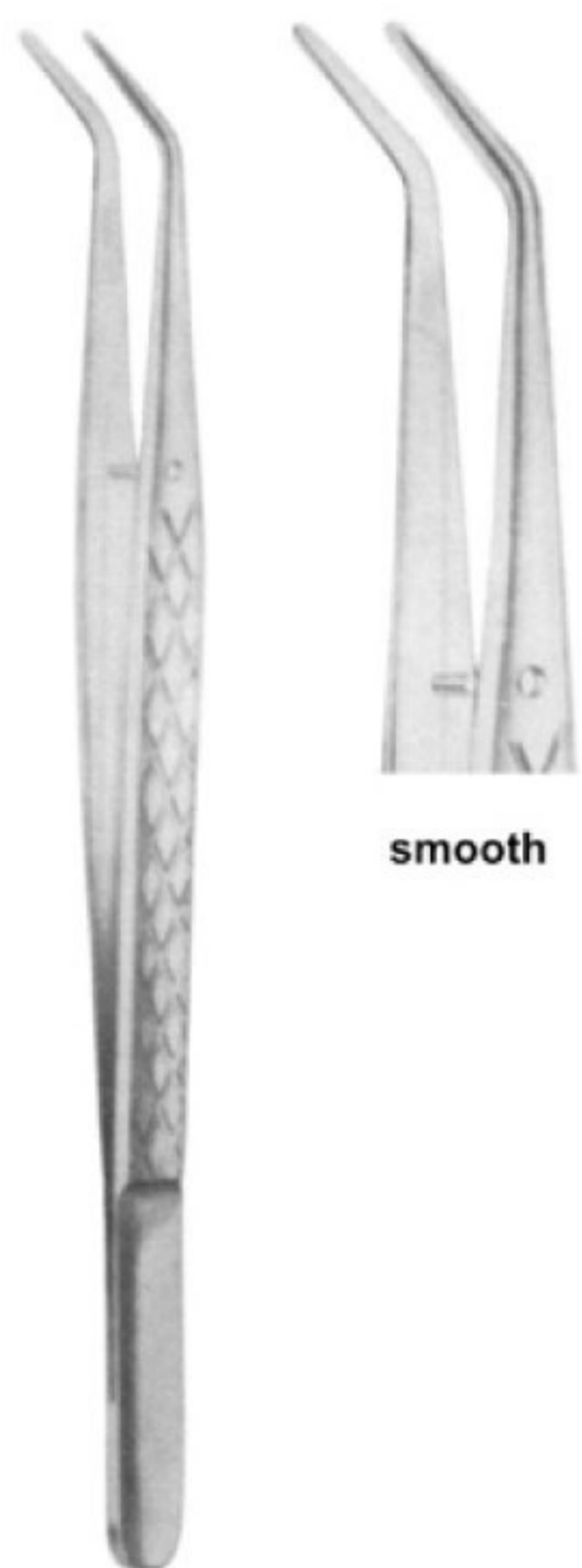

COLLEGE 15 cm
MWD-2336
 COLLEGE 15 cm

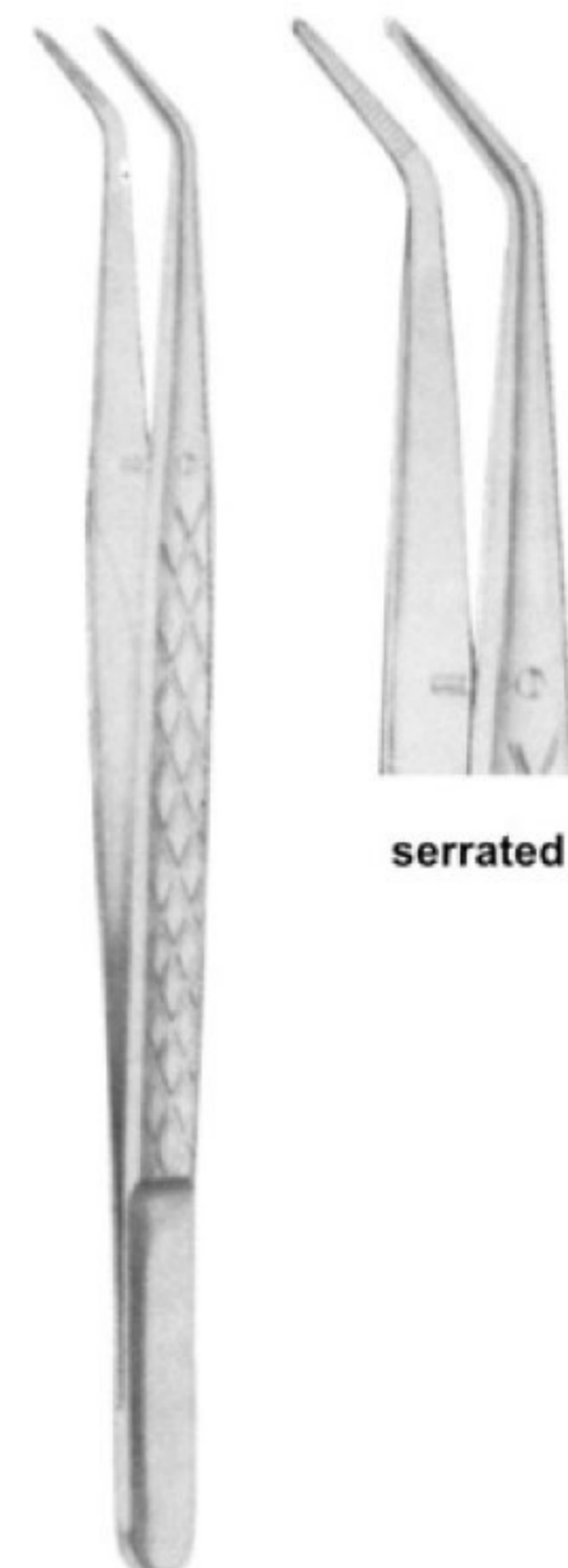

COLLEGE 15 cm
MWD-2337
 COLLEGE 15 cm

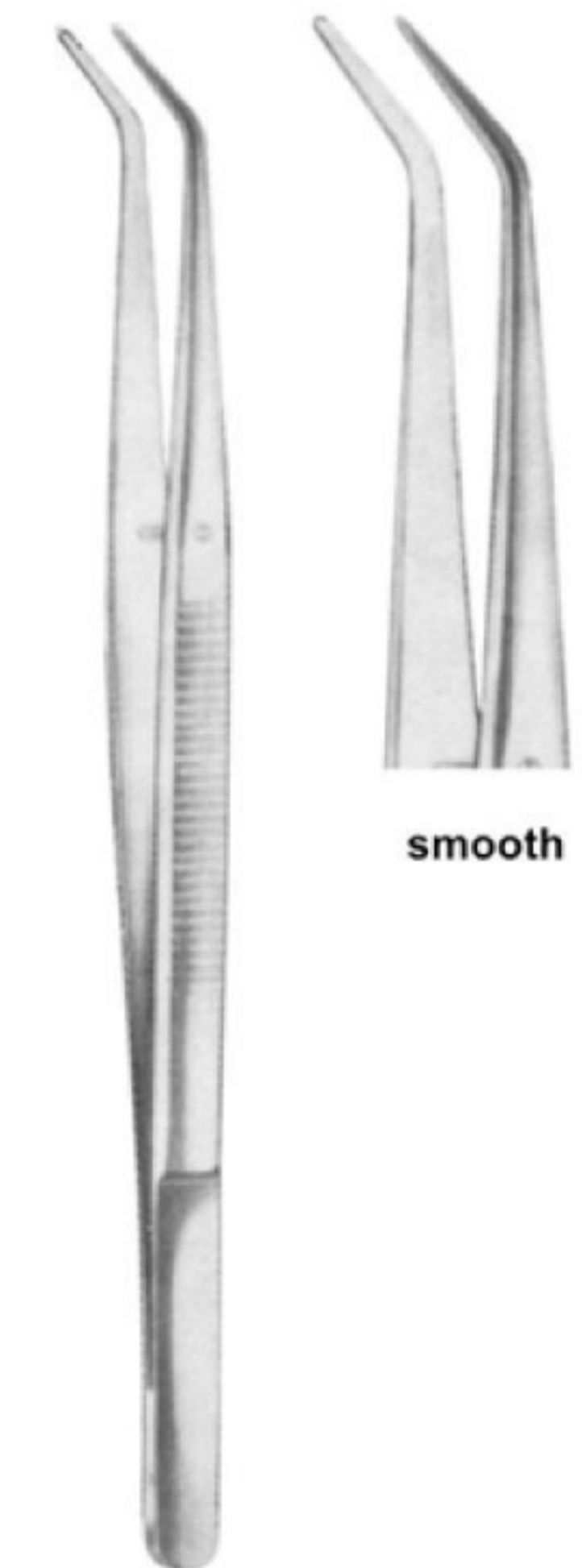

COLLEGE 15 cm
MWD-2338
 COLLEGE

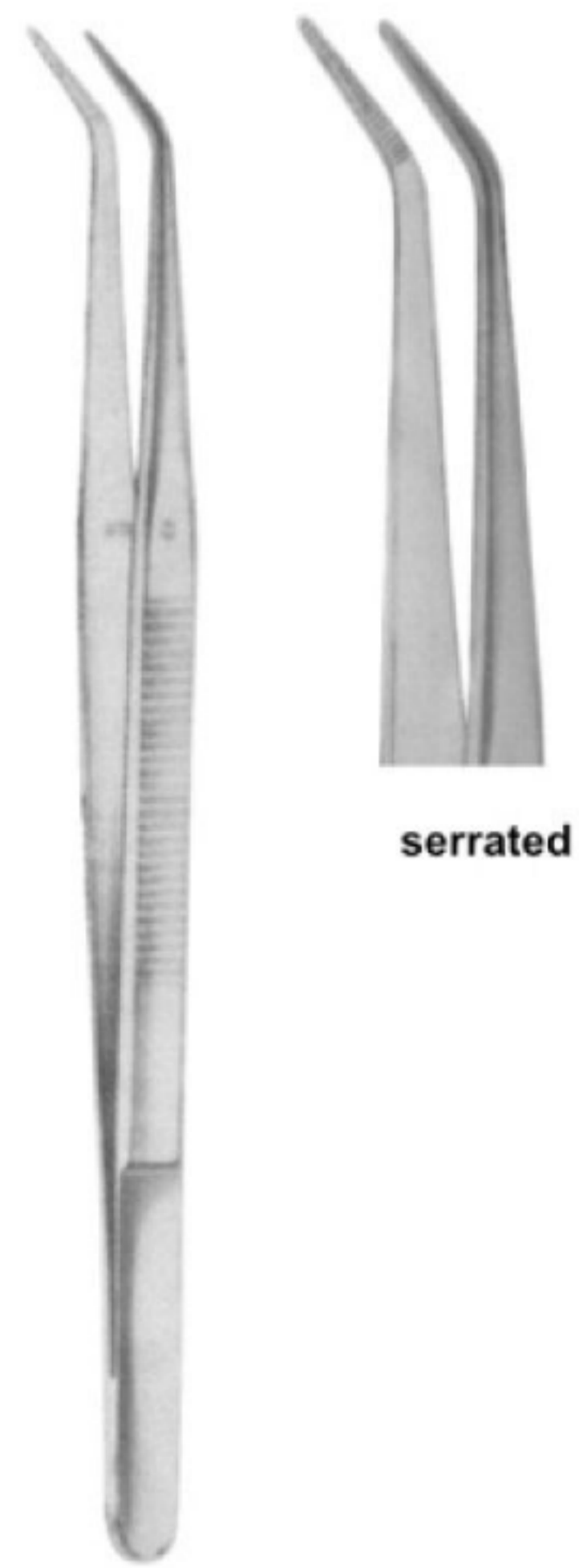

serrated

COLLEGE 15 cm
MWD-2339
COLLEGE 15 cm

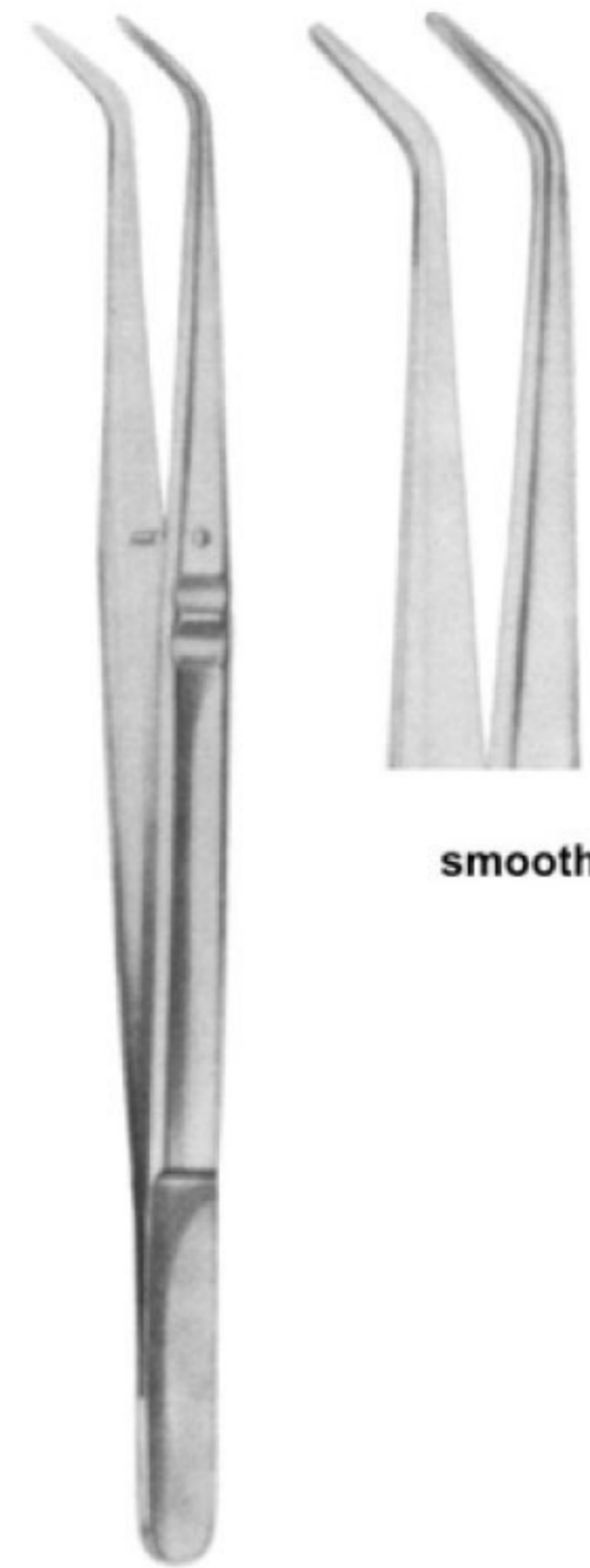

smooth

COLLEGE 15 cm
MWD-2340
COLLEGE 15 cm

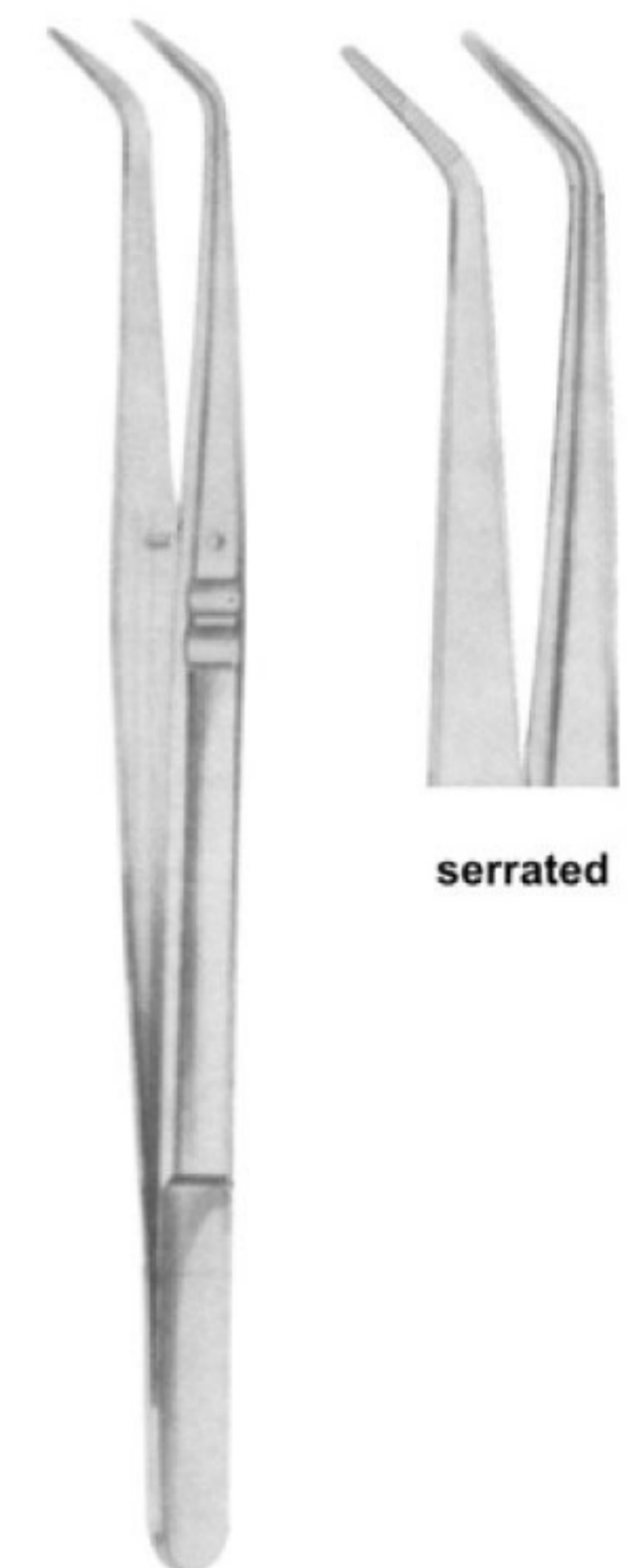

serrated

COLLEGE 15 cm
MWD-2341
COLLEGE 15 cm

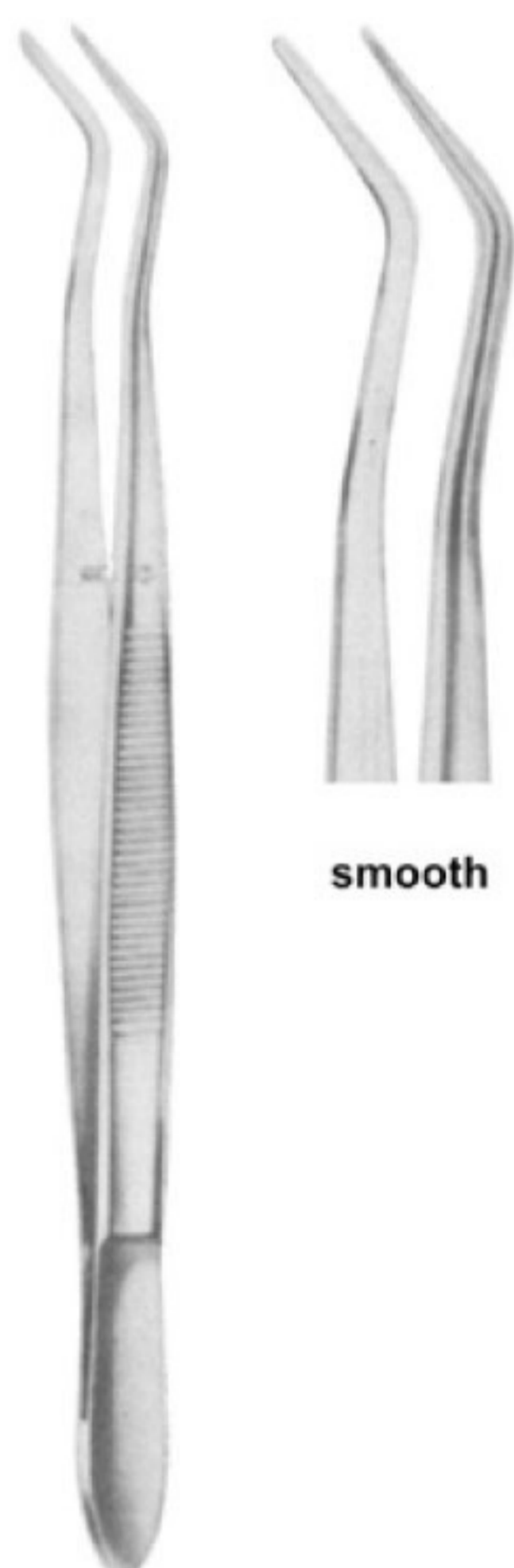

smooth

COLLEGE 15 cm
MWD-2342
COLLEGE 15 cm

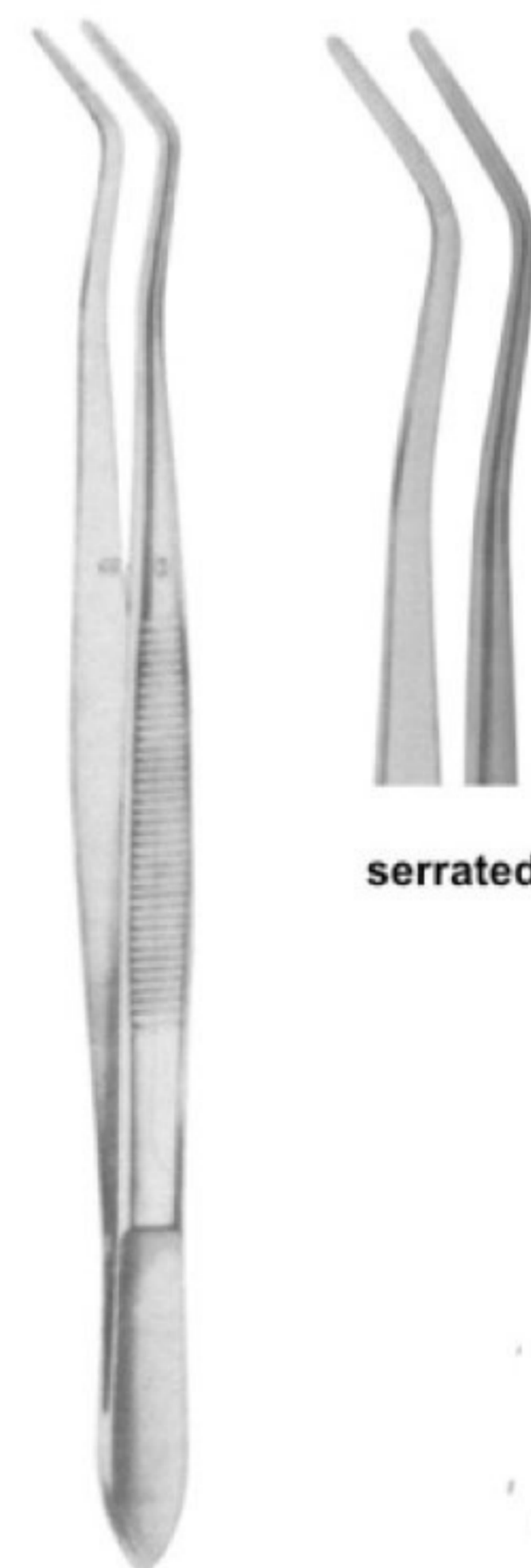

serrated

COLLEGE 15 cm
MWD-2343
COLLEGE 15 cm

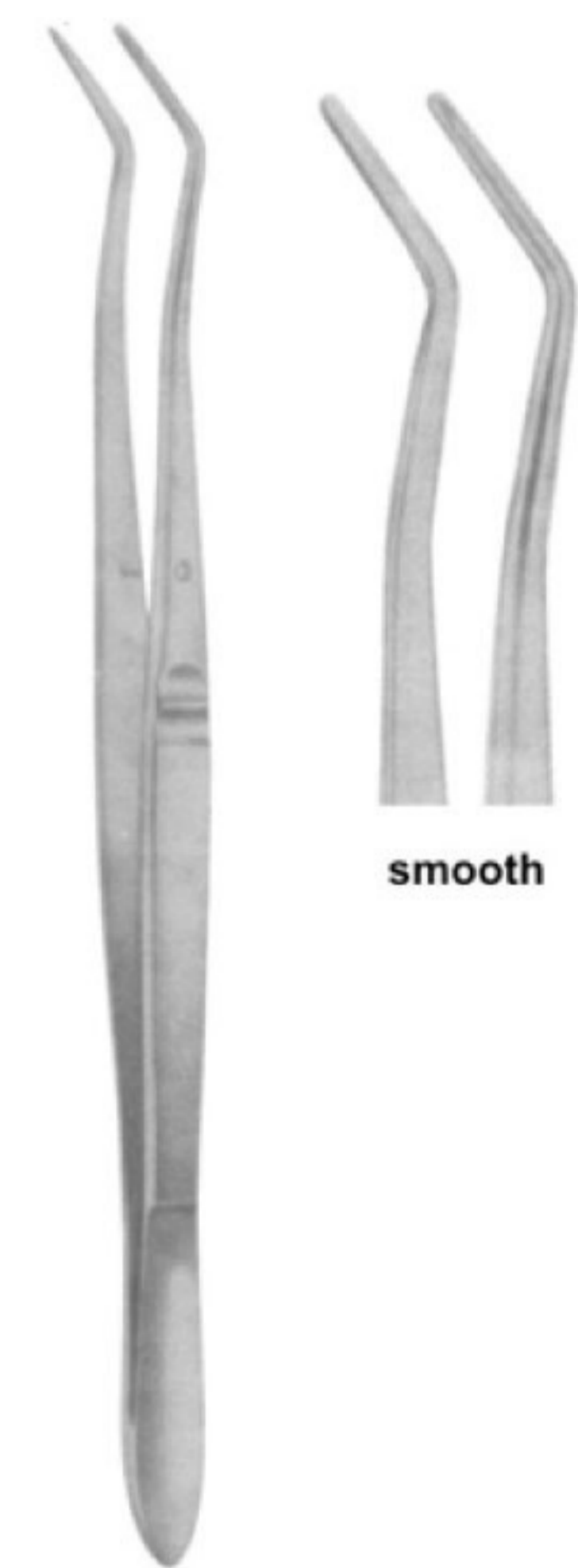

smooth

MERIAM 16 cm
MWD-2344
MERIAM 16 cm

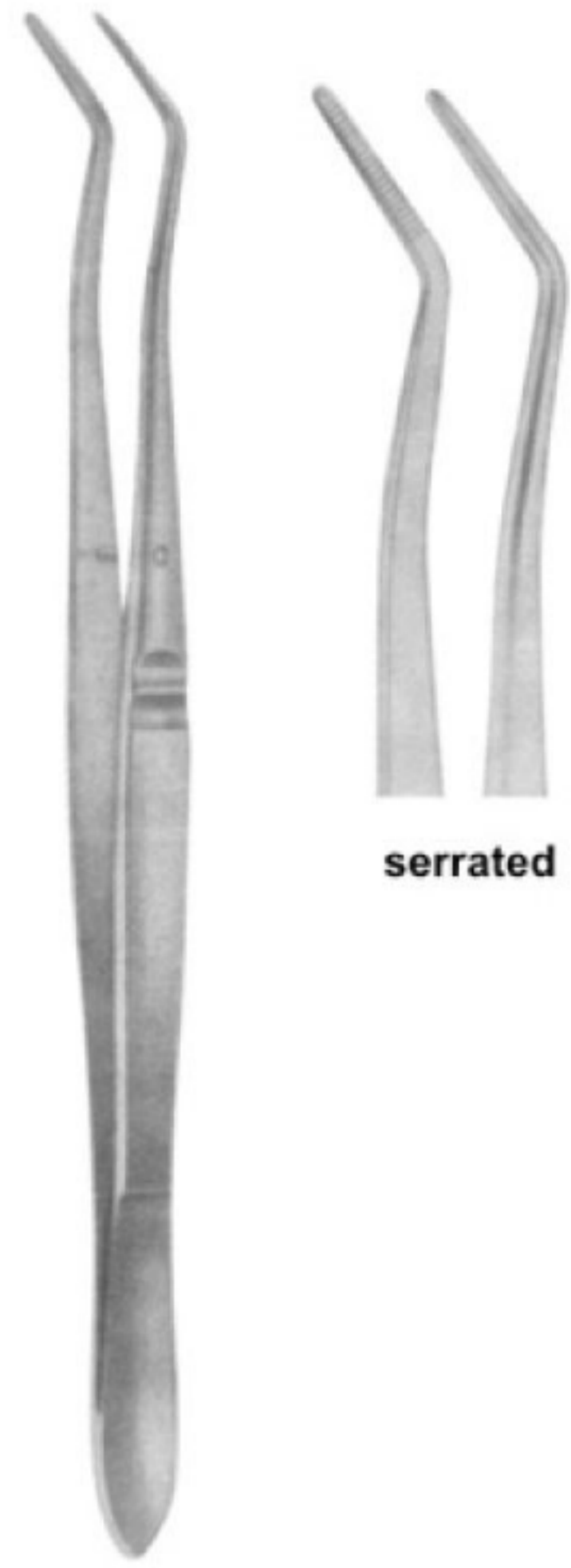

serrated

MERIAM 16 cm
MWD-2345
MERIAM 16 cm

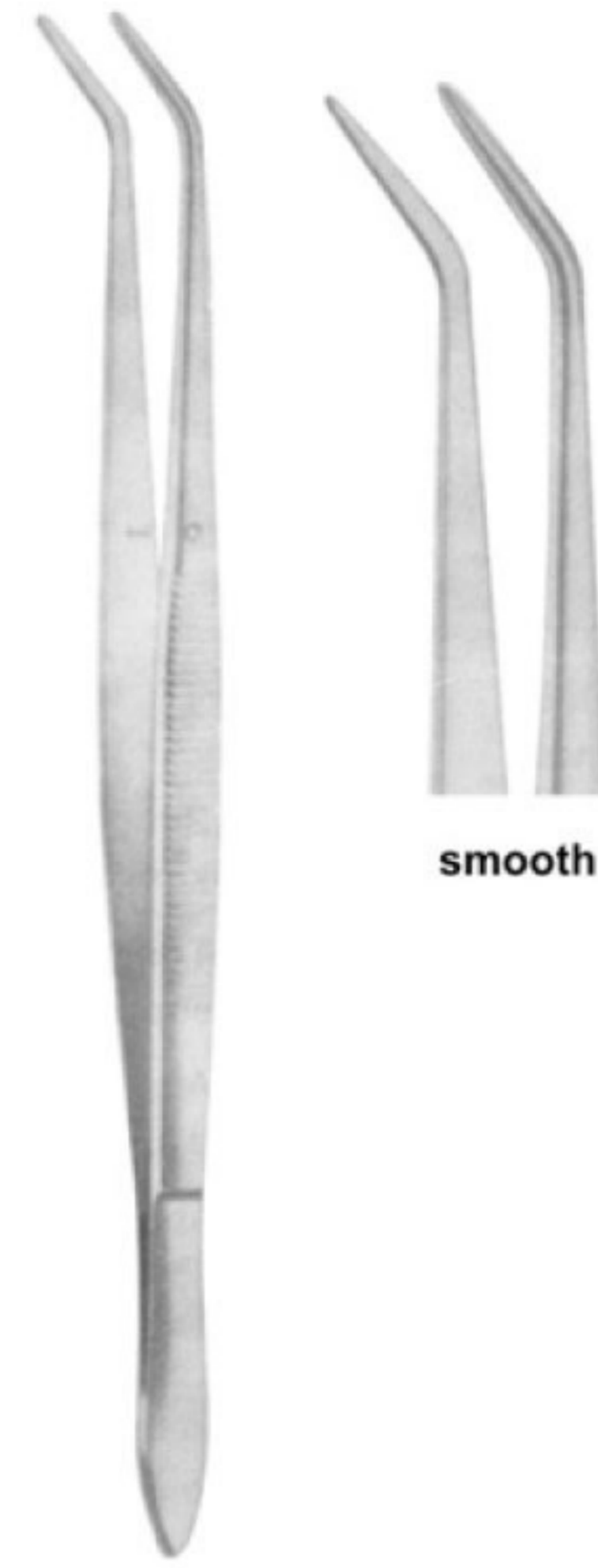

smooth

MERIAM 16 cm
MWD-2346
MERIAM 16 cm

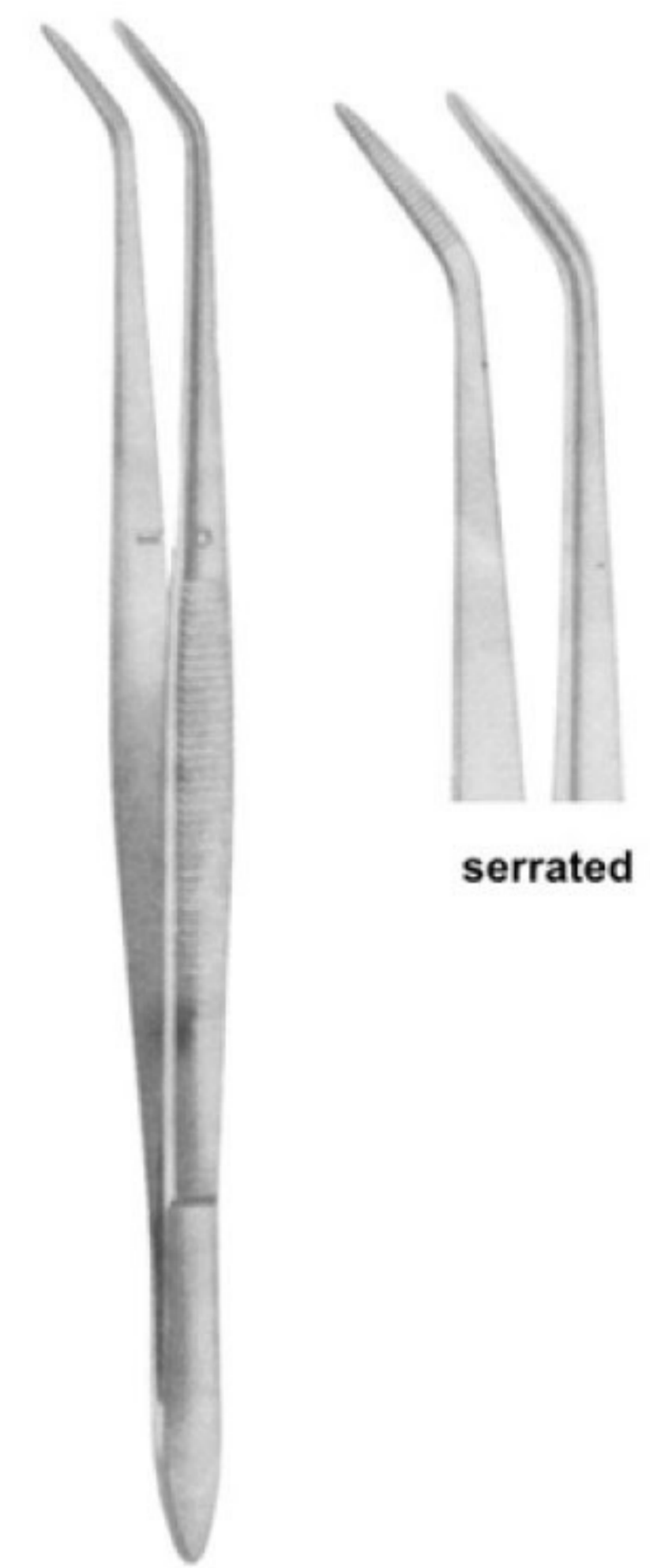

serrated

MERIAM 16 cm1
MWD-2347
MERIAM 16 cm1

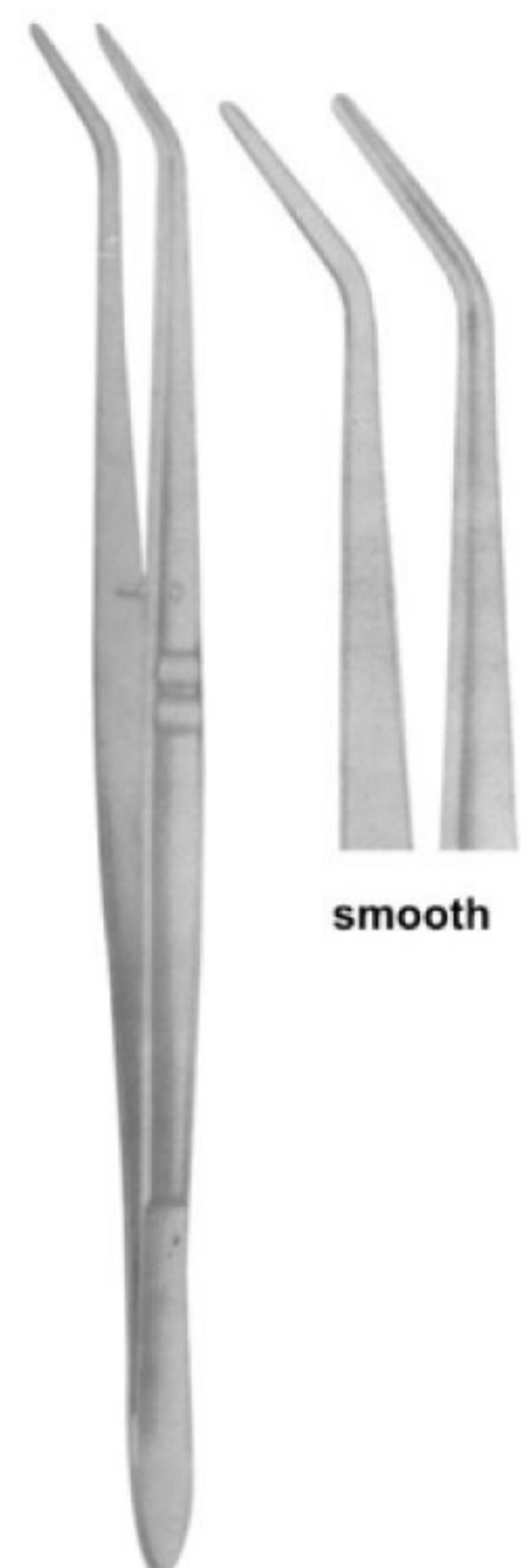

smooth

MERIAM 16 cm
MWD-2348
MERIAM 16 cm

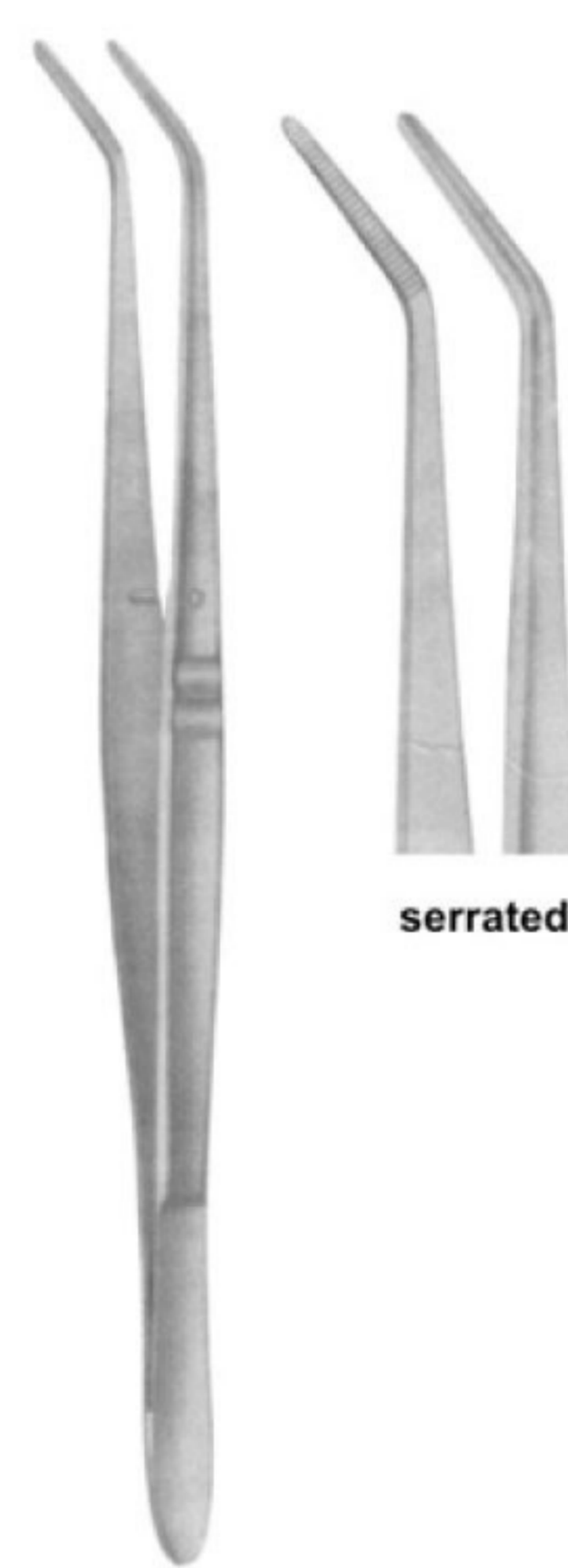

serrated

MERIAM 16 cm
MWD-2349
MERIAM 16 cm

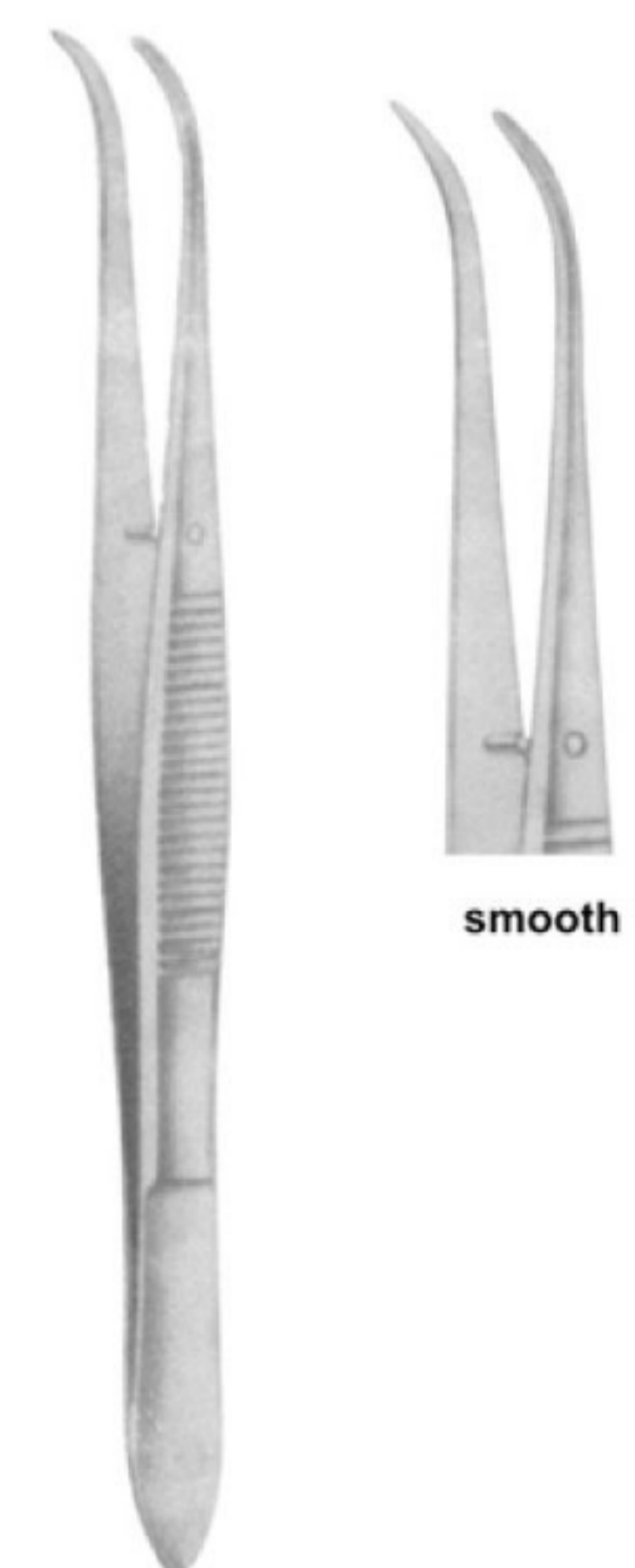

smooth

MERIAM 16 cm
MWD-2350
MERIAM 16 cm

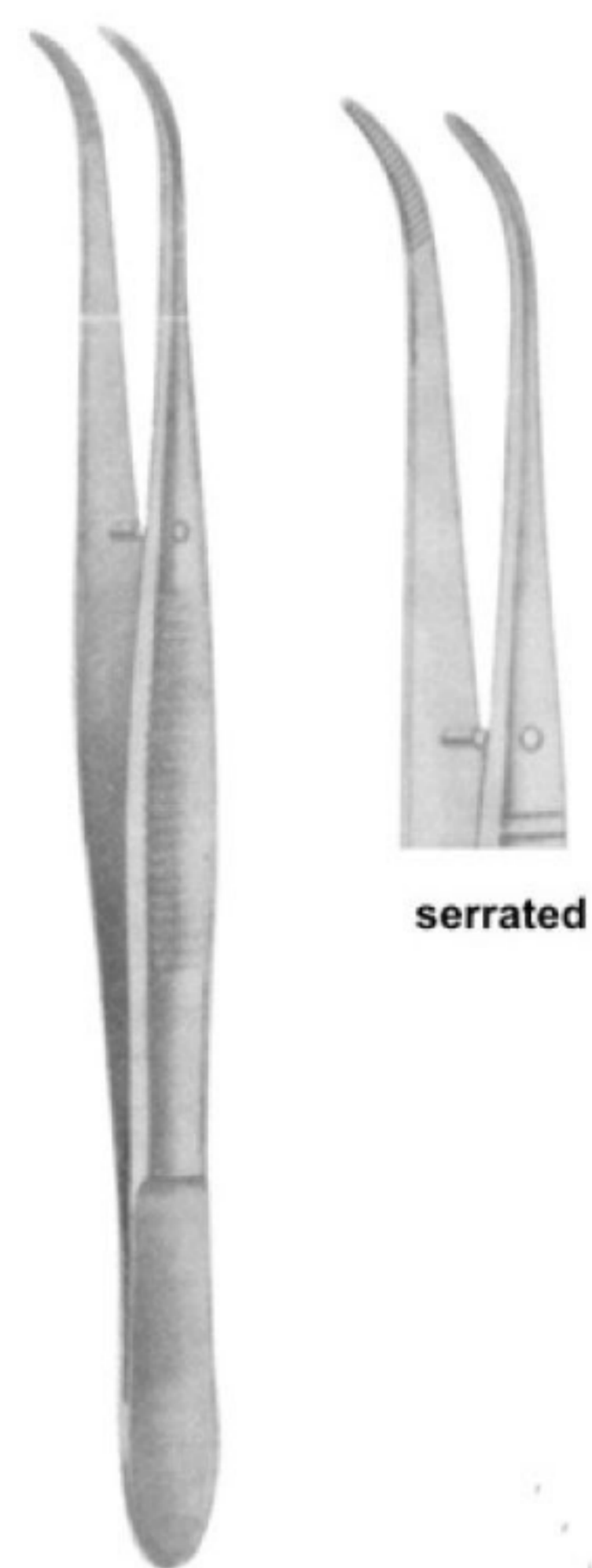

MERIAM 16 cm
MWD-2351
 MERIAM 16 cm

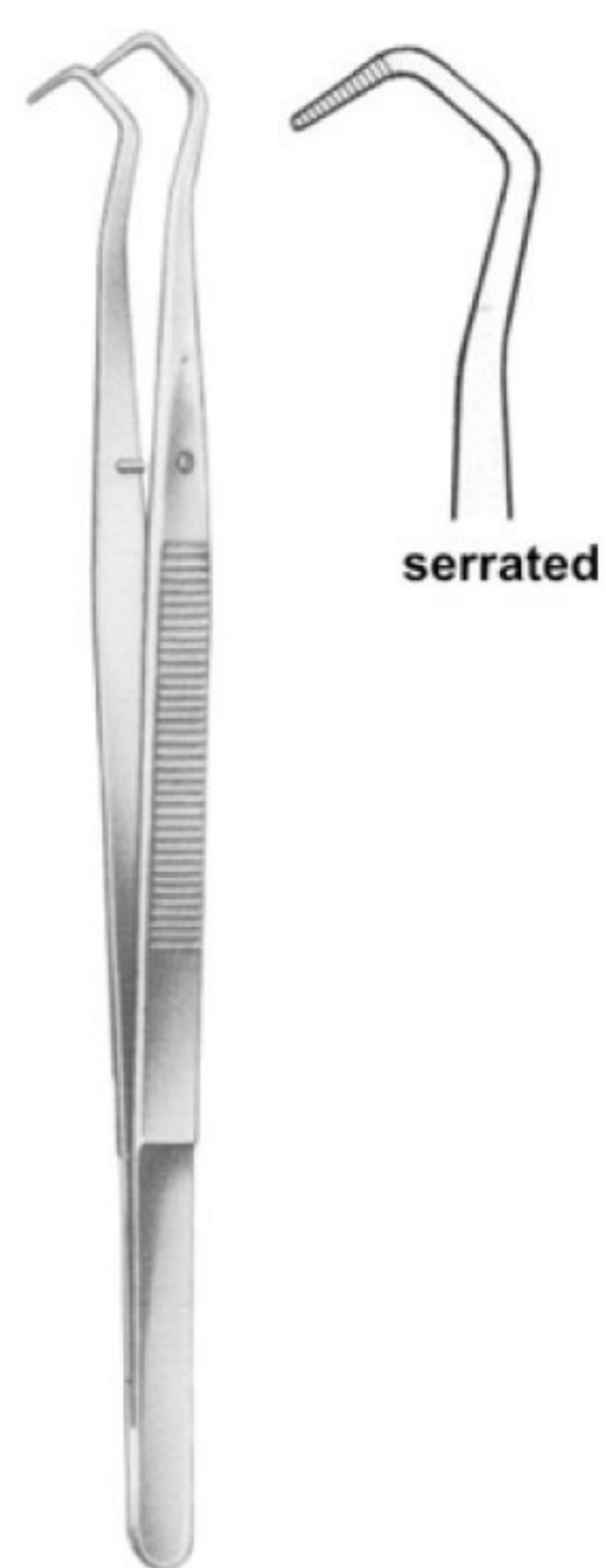

COLLEGE 14.5 cm, 5 3/4"
MWD-2352
 COLLEGE 14.5 cm, 5 3/4"

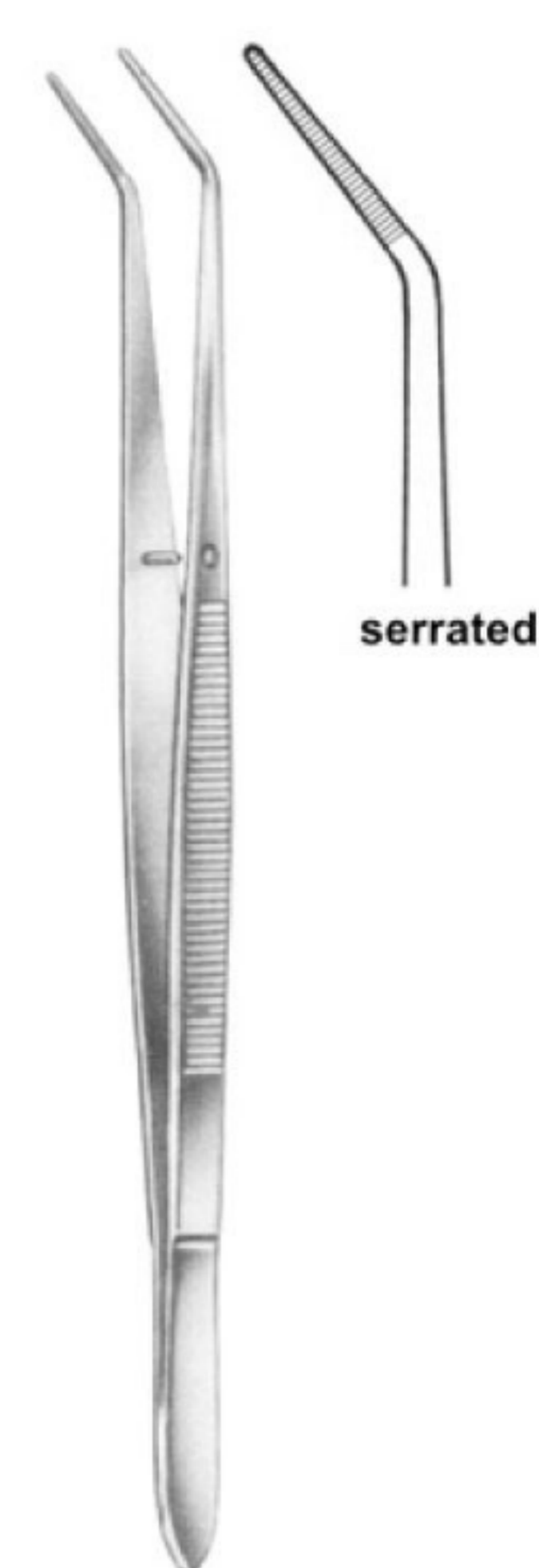

FLAGG 16 cm, 6 1/4"
MWD-2353
 FLAGG 16 cm, 6 1/4"

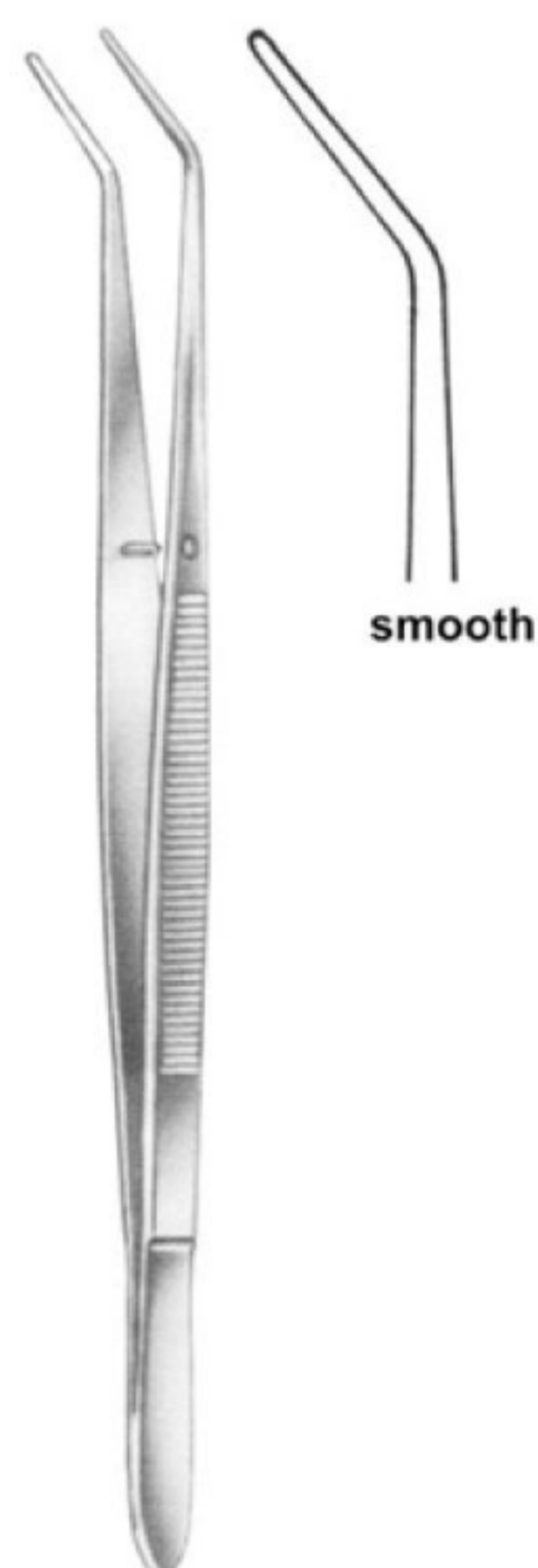

FLAGG 16 cm, 6 1/4"
MWD-2354
 FLAGG 16 cm, 6 1/4"

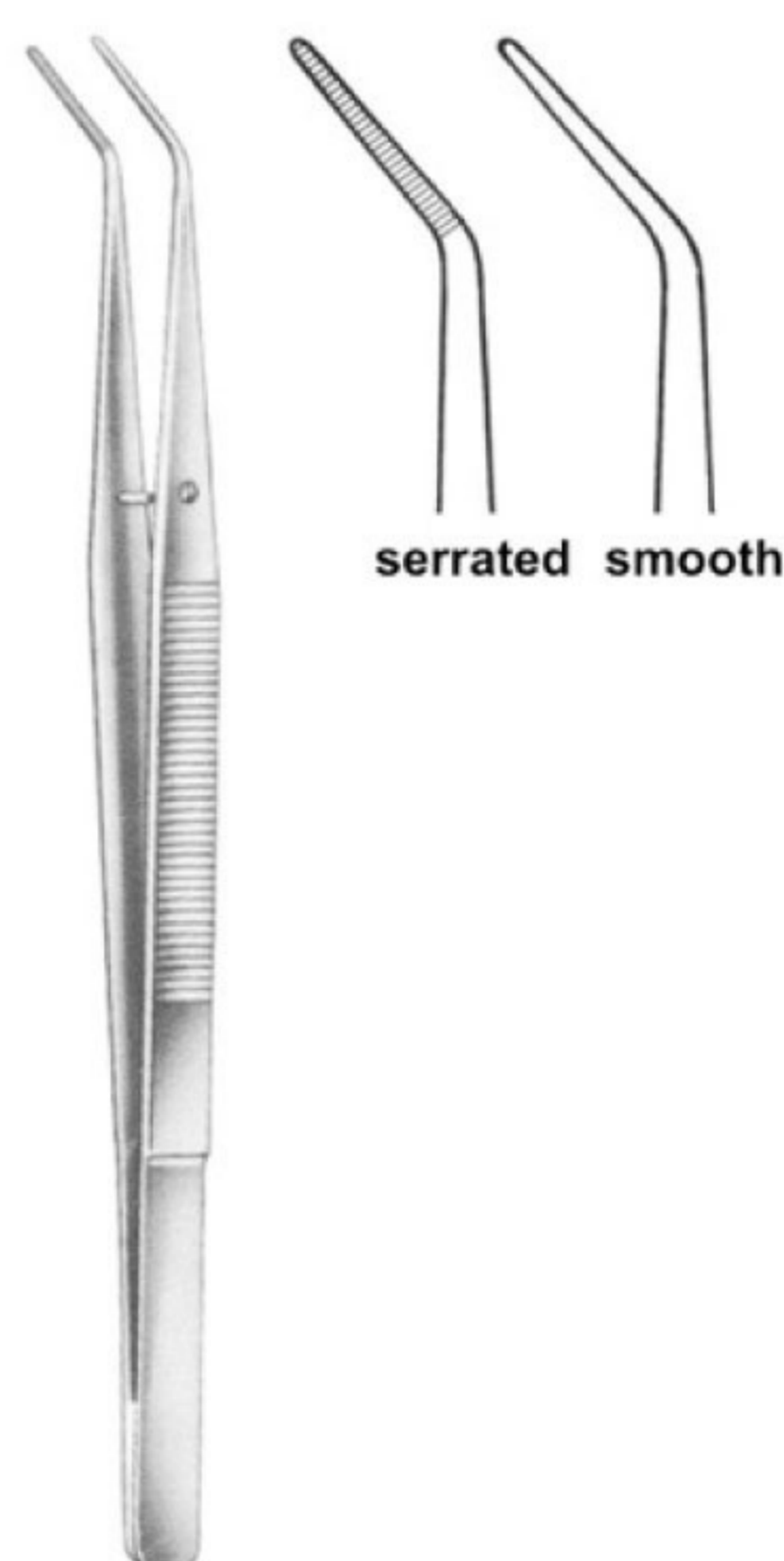

LANDGRAF 15 cm, 6"
MWD-2355
 LANDGRAF 15 cm, 6"

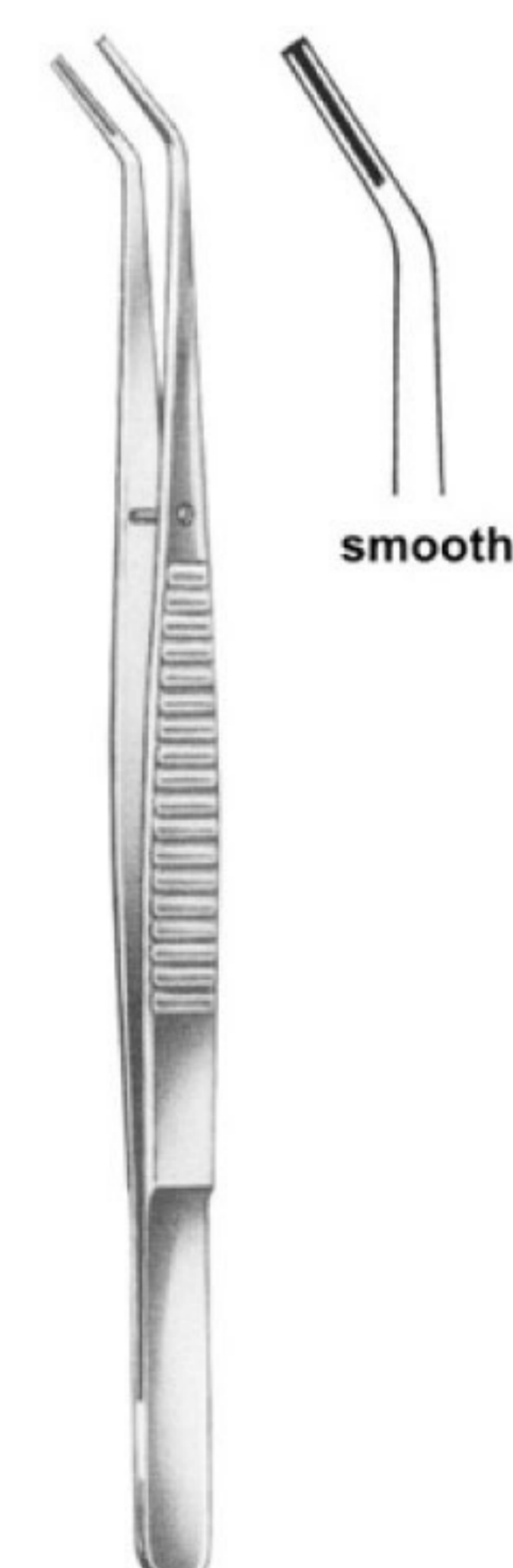

15,5 cm, 6 1/8"
MWD-2356
 15,5 cm, 6 1/8"



15.5 cm, 6 1/8"
MWD-2357
 15.5 cm, 6 1/8"

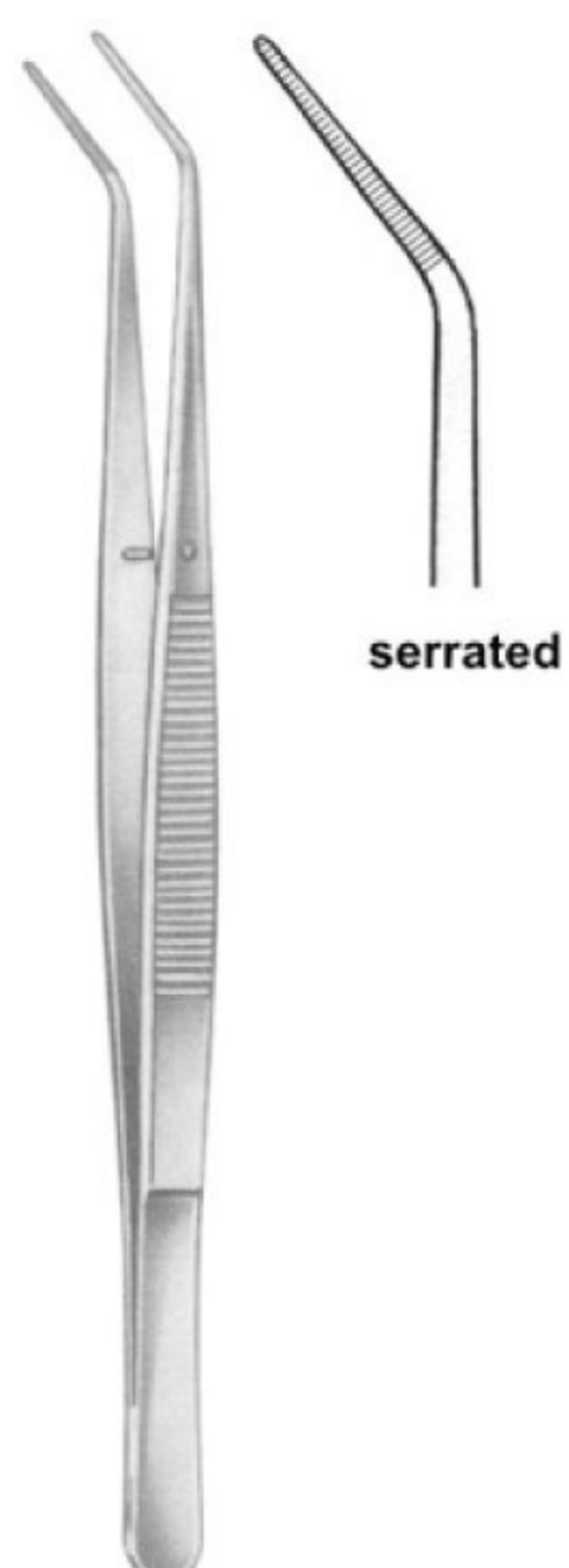

LONDON-COLLEGE 15 cm, 6"
MWD-2358
 LONDON-COLLEGE 15 cm, 6"

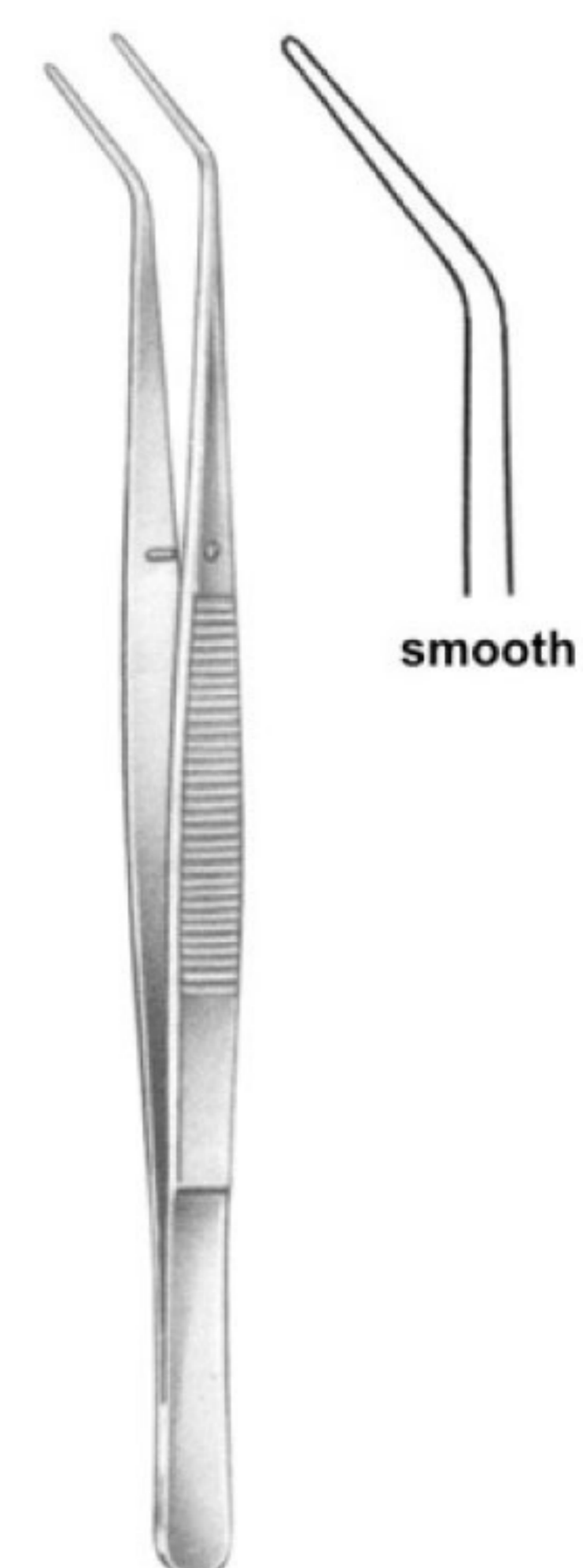

LONDON-COLLEGE 15 cm, 6"
MWD-2359
 LONDON-COLLEGE 15 cm, 6"

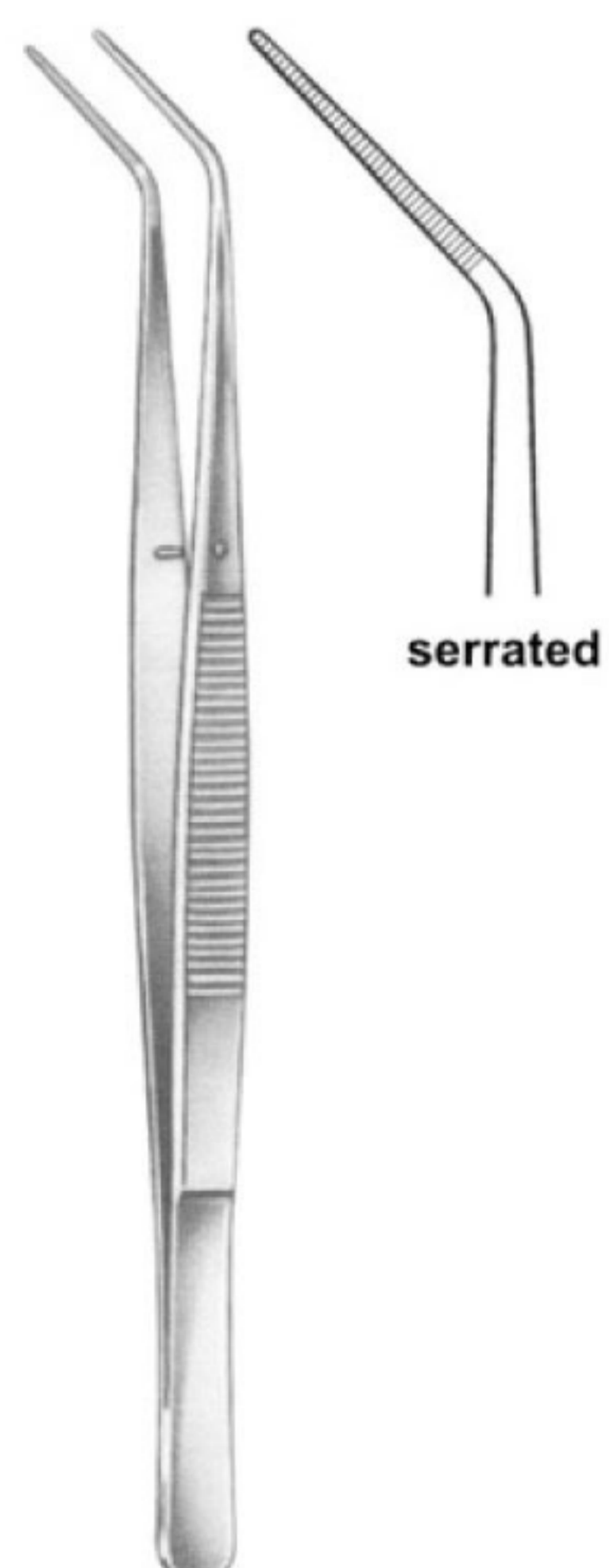

LONDON-COLLEGE 15 cm, 6"
MWD-2360
 LONDON-COLLEGE 15 cm, 6"

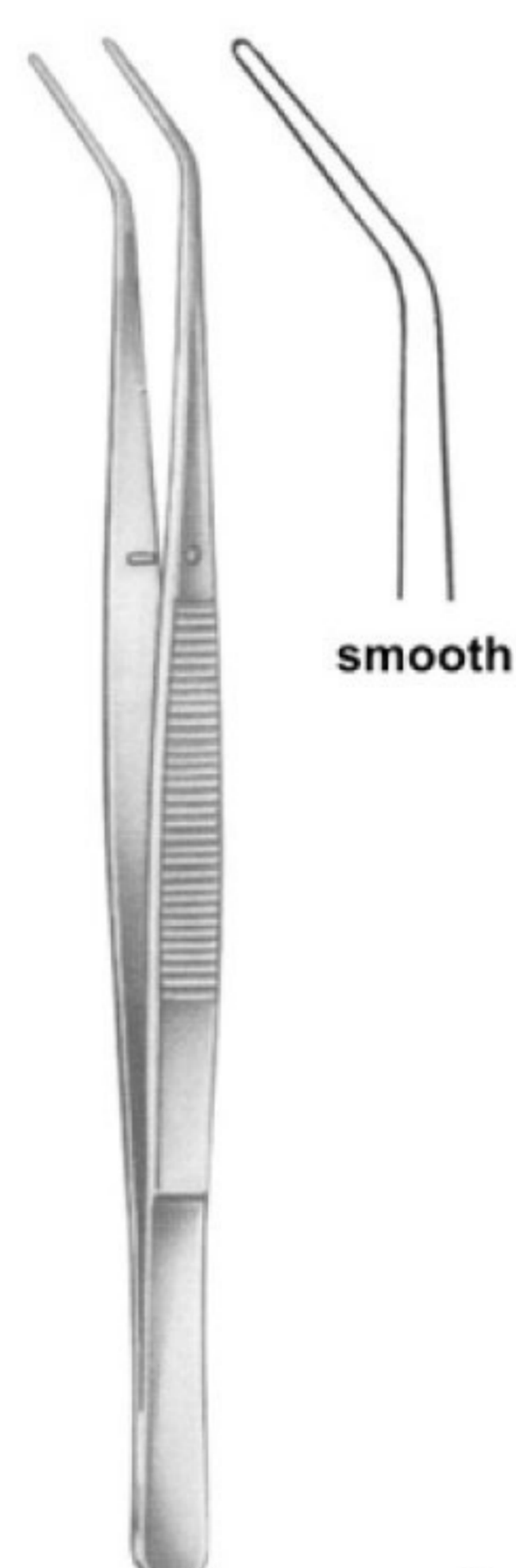

LONDON-COLLEGE 15 cm, 6"
MWD-2361
 LONDON-COLLEGE 15 cm, 6"

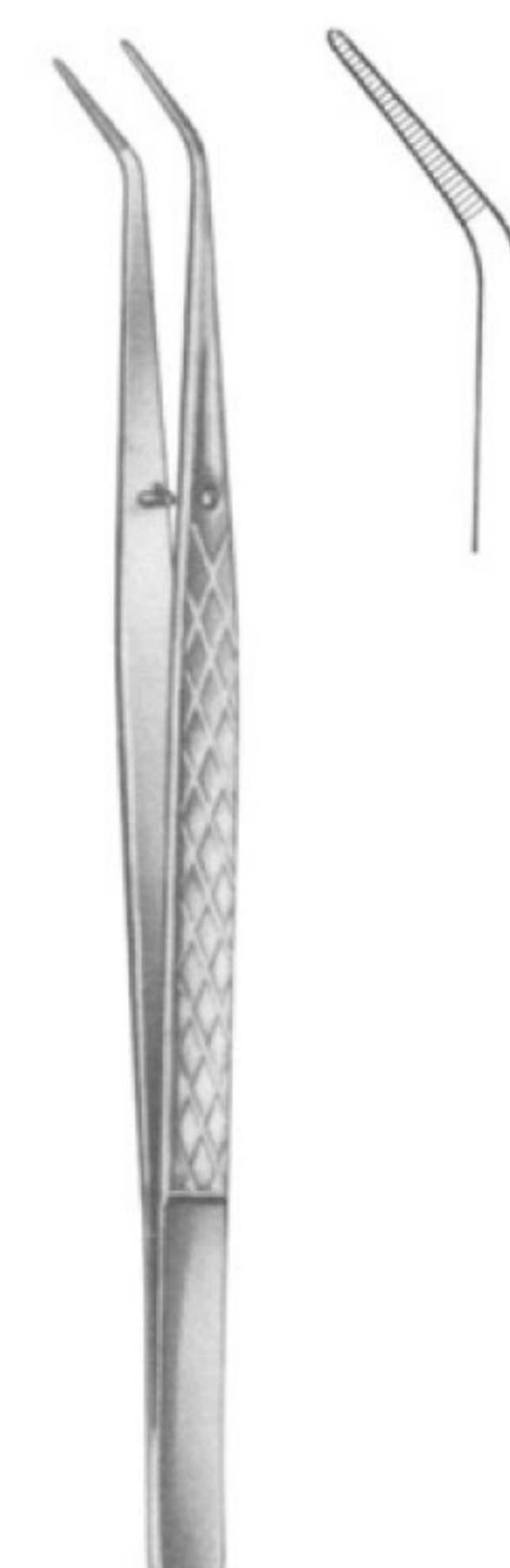

LONDON-COLLEGE 15 cm, 6"
MWD-2362
 LONDON-COLLEGE 15 cm, 6"

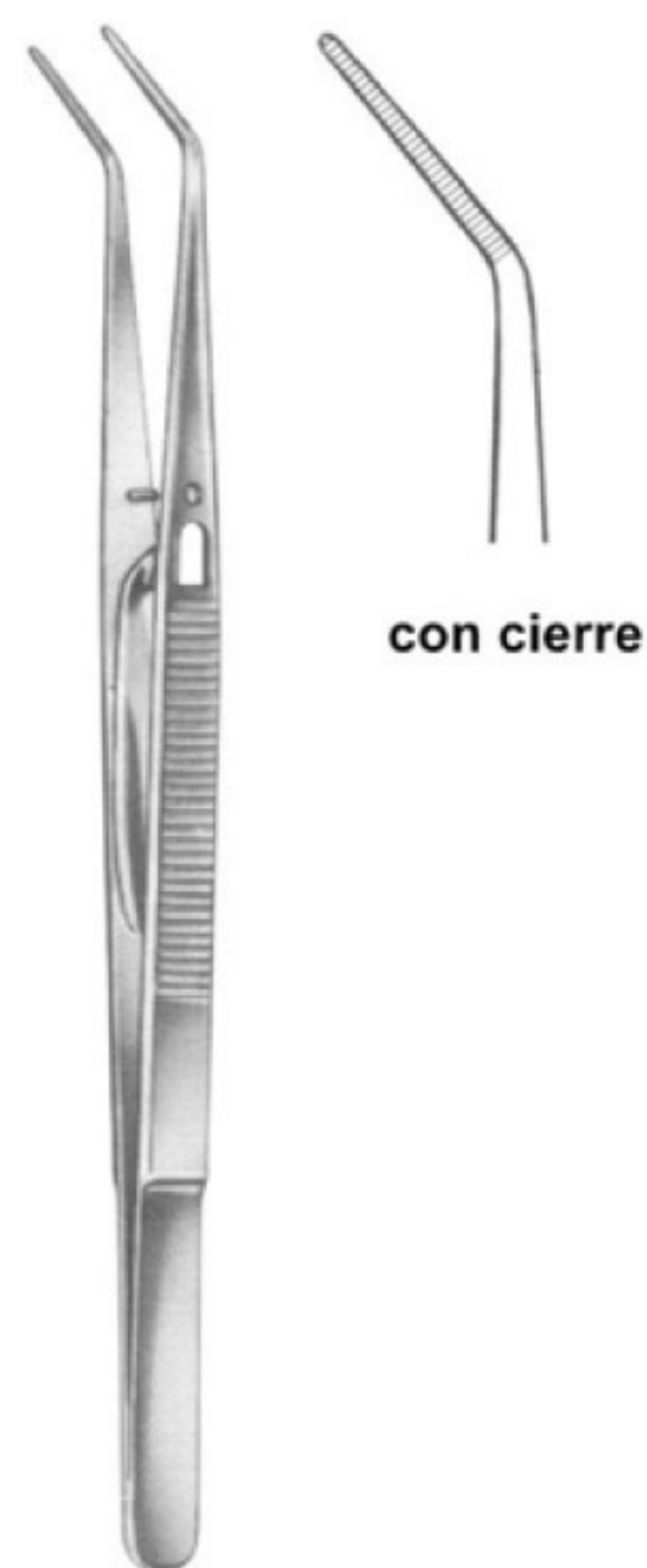

LONDON-COLLEGE 15 cm, 6"
MWD-2363
 LONDON-COLLEGE 15 cm, 6"

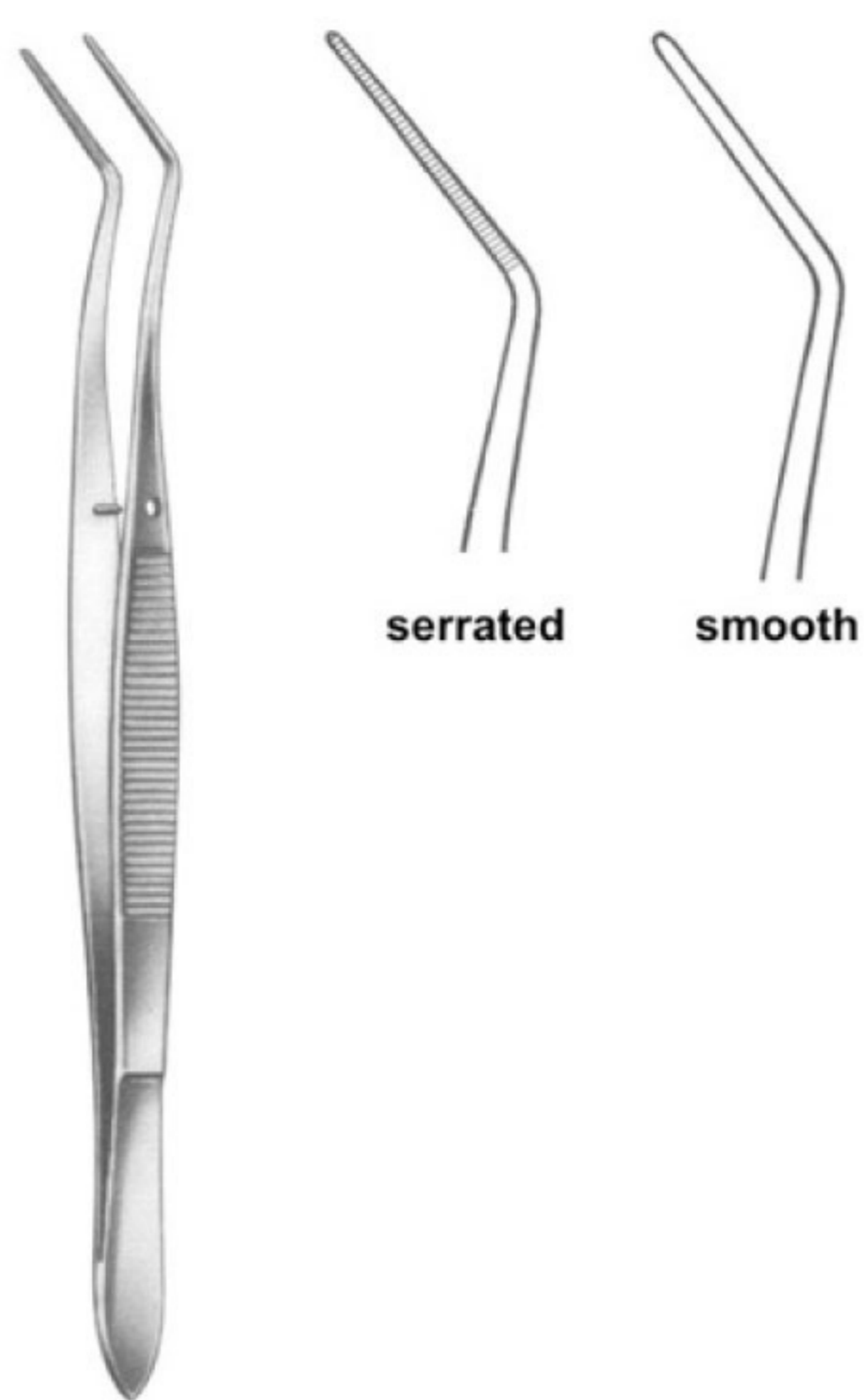

MERIAM 16 cm, 6 1/4"
MWD-2364
 MERIAM 16 cm, 6 1/4"

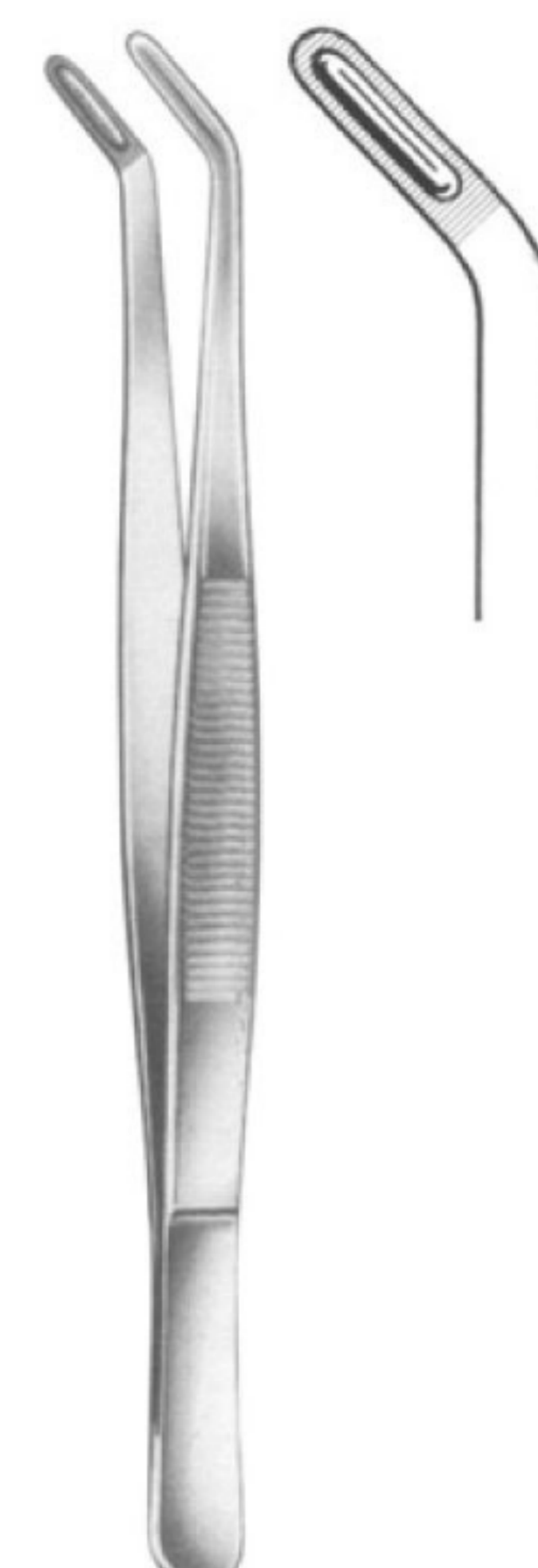

ALLEN 18 cm, 7 1/8"
MWD-2365
 ALLEN 18 cm, 7 1/8"

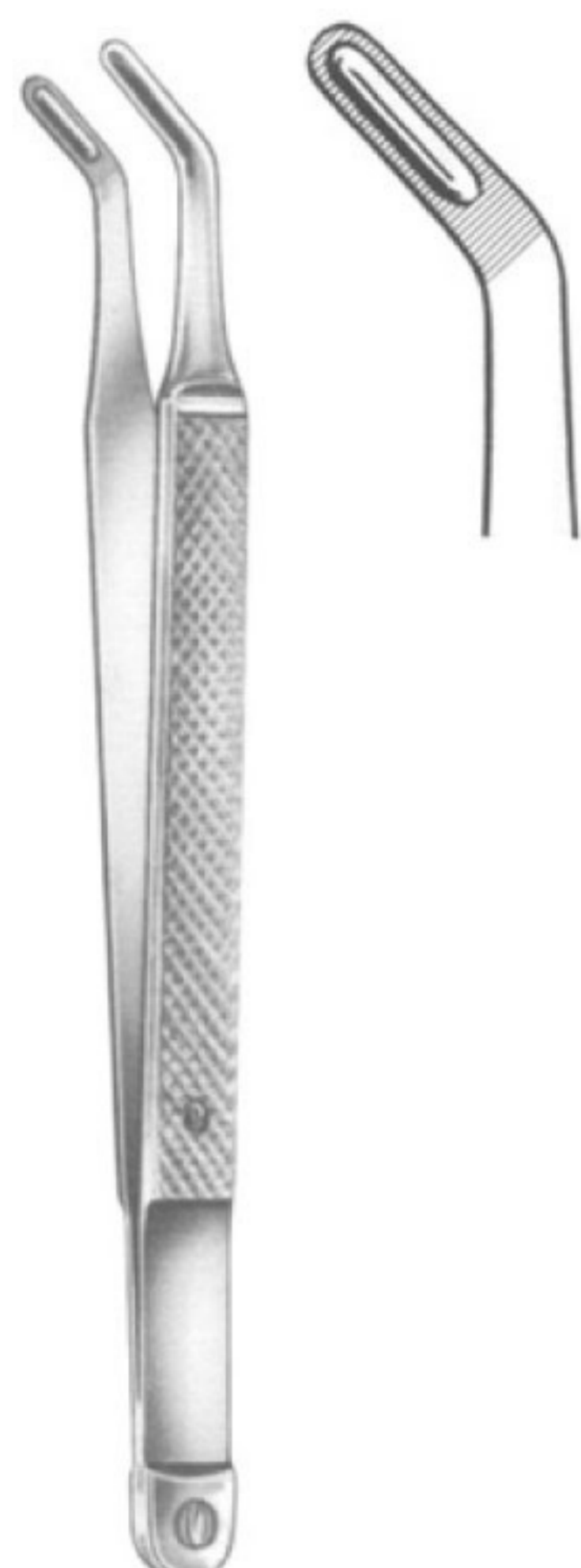

ALBRECHT 16 cm, 6 1/4"
MWD-2366
 ALBRECHT 16 cm, 6 1/4"



ALBRECHT 16 cm, 6 1/4"
MWD-2367
 ALBRECHT 16 cm, 6 1/4"

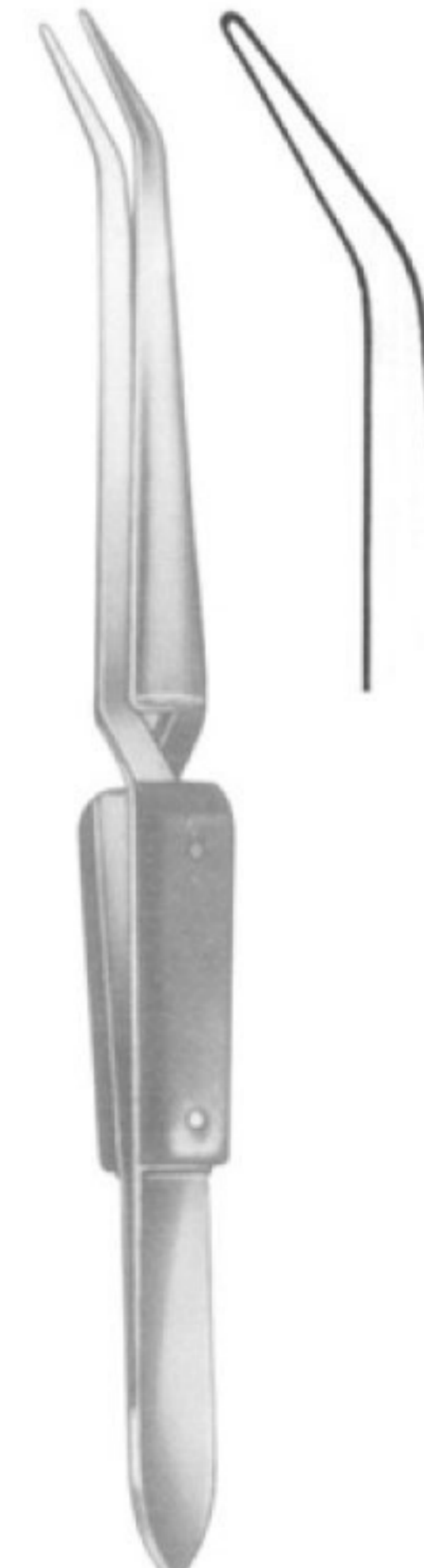

16 cm, 6 1/4"
MWD-2368
 16 cm, 6 1/4"

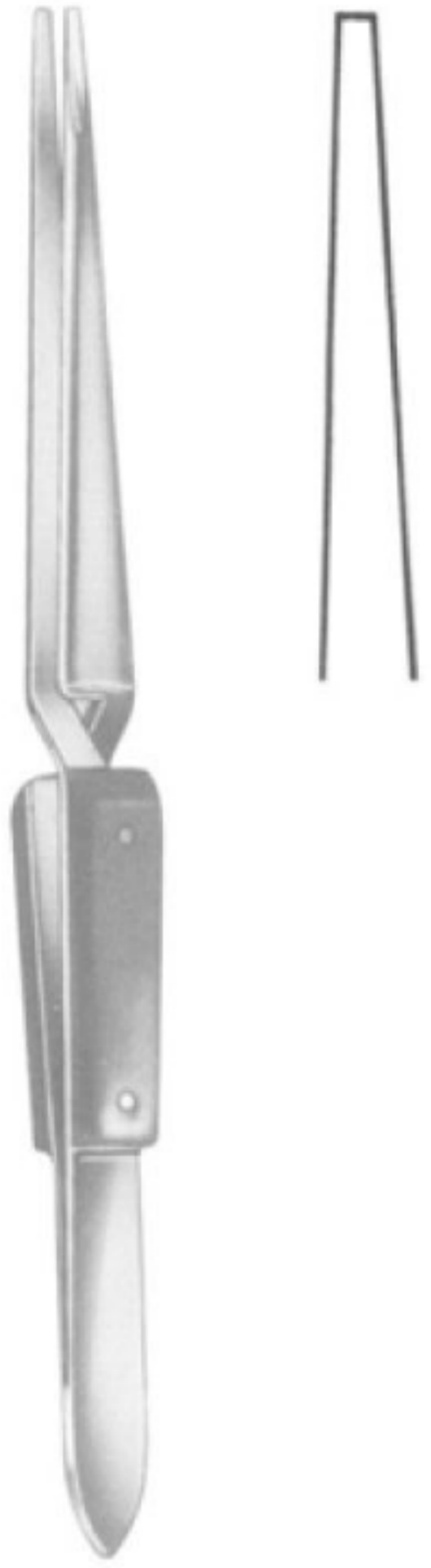

16 cm, 6 1/4"
MWD-2369
16 cm, 6 1/4"



16 cm, 6 1/4"
MWD-2370
16 cm, 6 1/4"

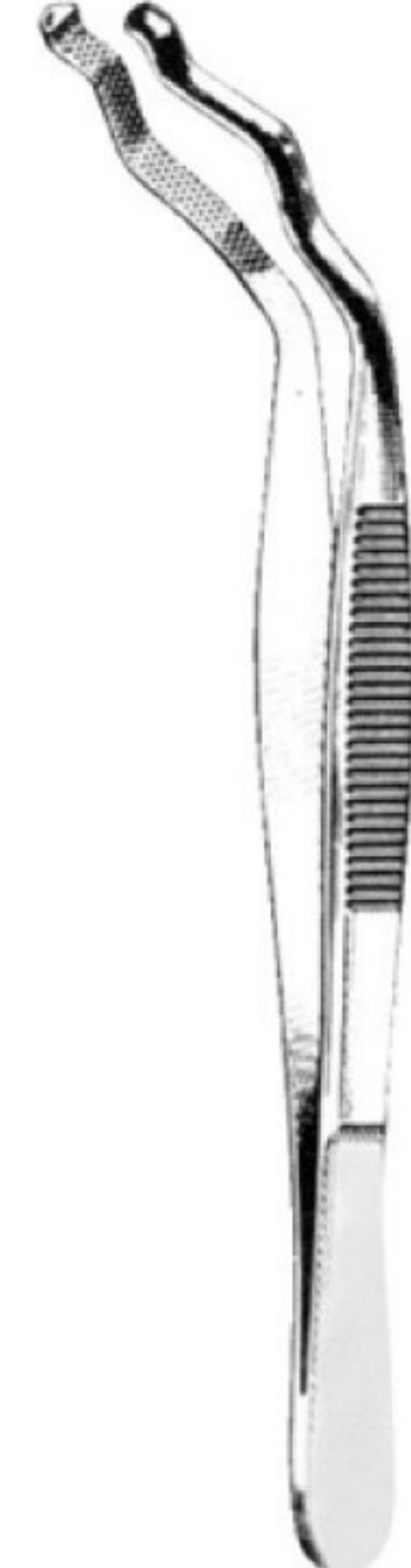

DAVIS 6"
MWD-2371
DAVIS 6"

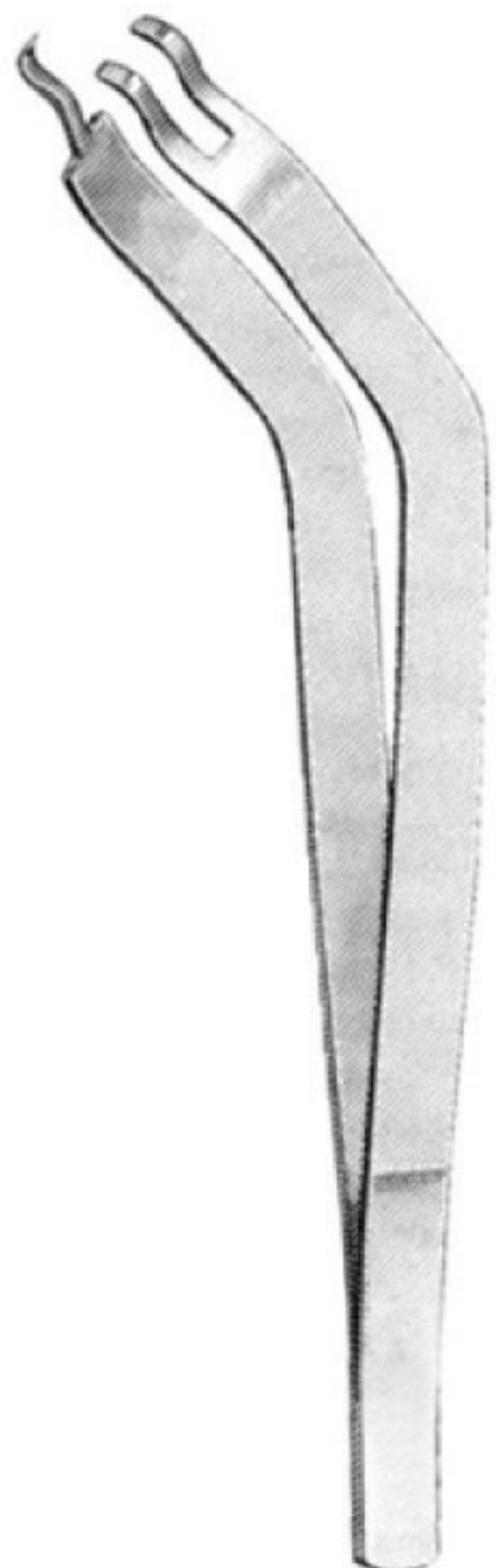

Grasping Forceps 6 1/4"
MWD-2372
Grasping Forceps 6 1/4"



Mesh Bur & Diamond Holder Large, 2 1/8" Diameter
MWD-2373
Mesh Bur & Diamond Holder Large, 2 1/8" Diameter

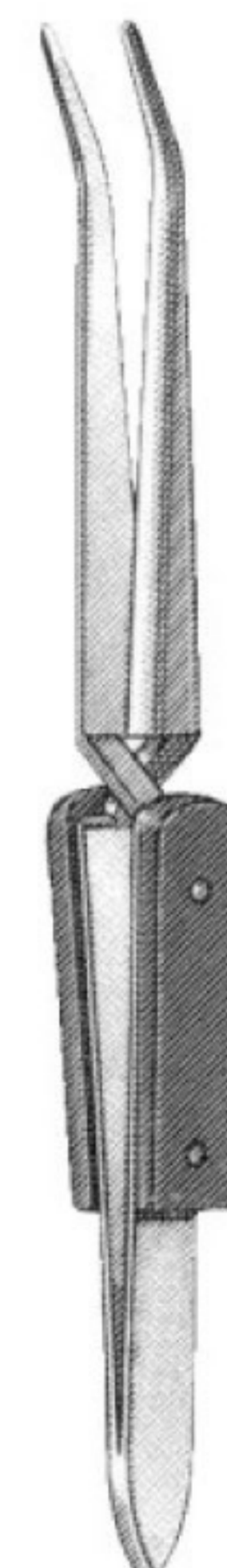

Soldering Tweezers 6 1/4"
MWD-2374
Soldering Tweezers 6 1/4"



Narrow Fine 4 3/4"
MWD-2375
Narrow Fine 4 3/4"



Super Fine 4 3/8"
MWD-2376
Super Fine 4 3/8"



Fine Curved 4 1/2"
MWD-2377
Fine Curved 4 1/2"



Bonding Bracket Holder 136 mm
MWD-2378
Bonding Bracket Holder 136 mm



Bonding Bracket Holder 135 mm
MWD-2379
Bonding Bracket Holder 135 mm



Bonding Bracket Holder 135 mm
MWD-2380
Bonding Bracket Holder 135 mm

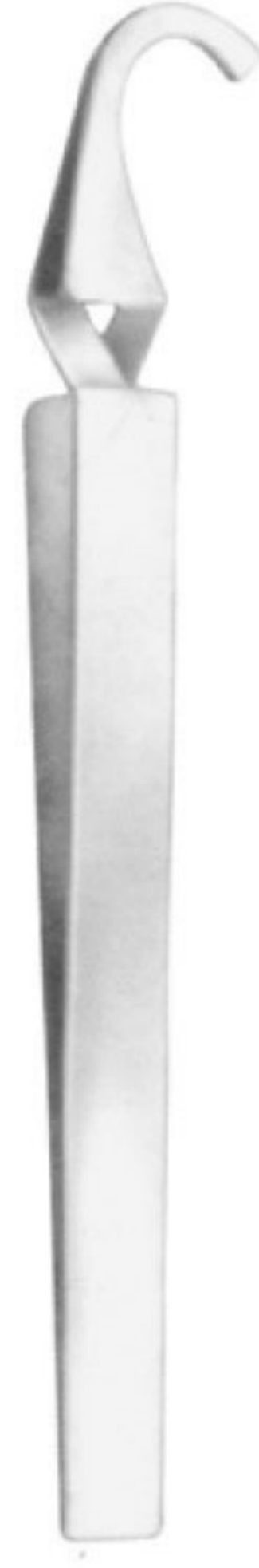

Bonding Bracket Holder 140 mm

MWD-2381

Bonding Bracket Holder 140 mm

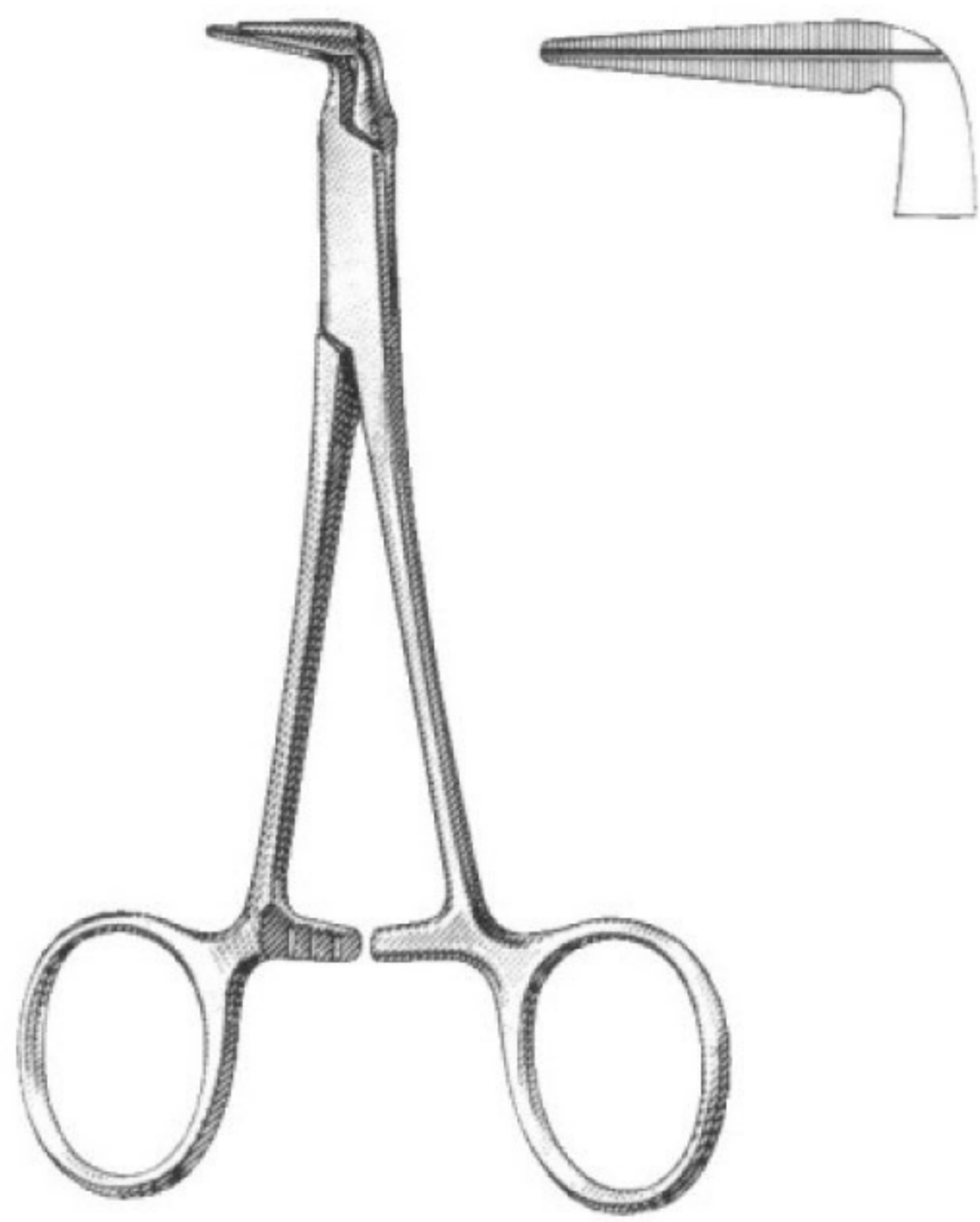

Endo Forceps 4 3/4"
MWD-2382
 Endo Forceps 4 3/4"

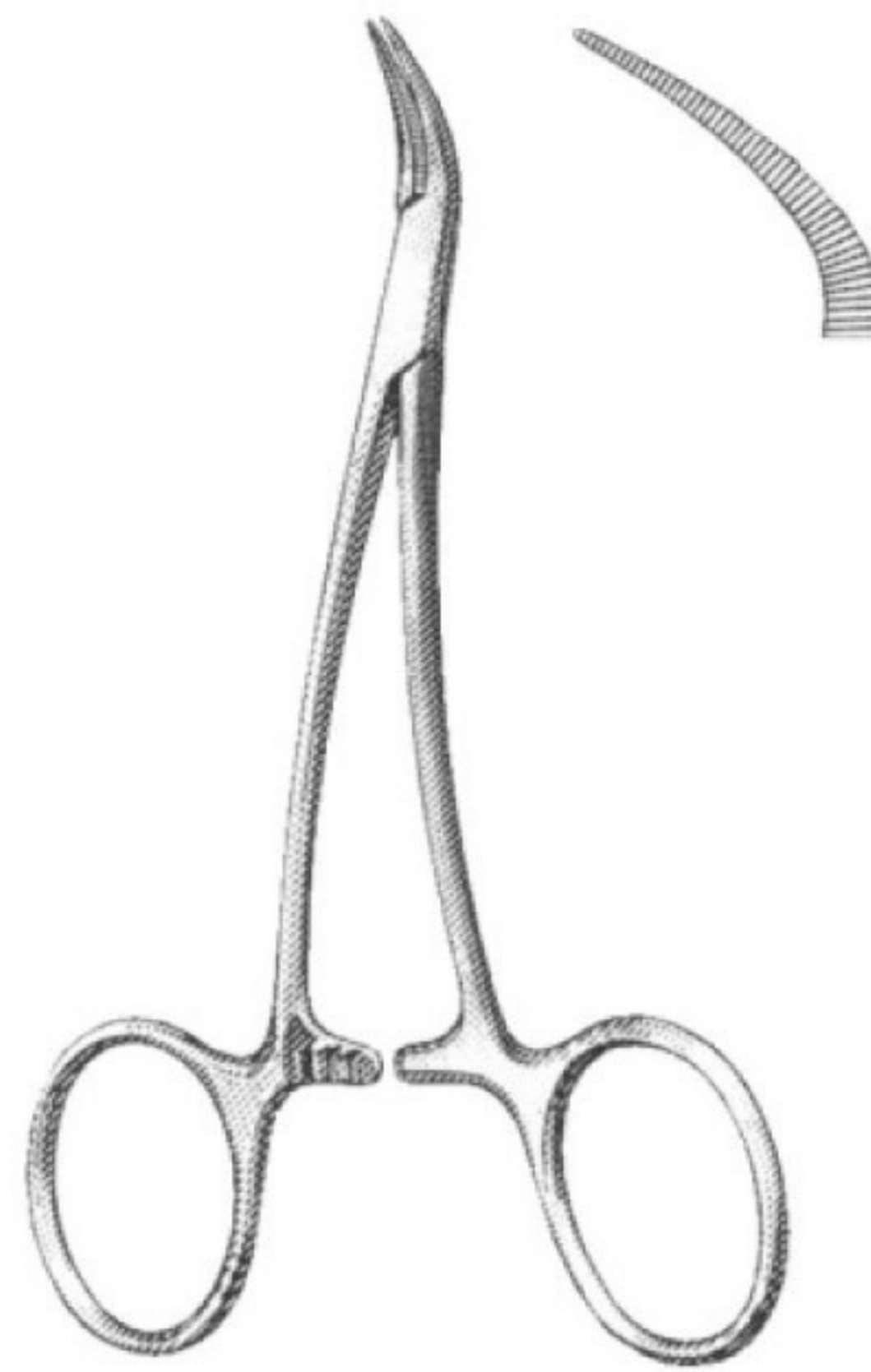

PEETS Forceps 4 3/4" , Useful For Removing Broken Instruments
MWD-2383
 PEETS Forceps 4 3/4" , Useful For Removing Broken Instruments

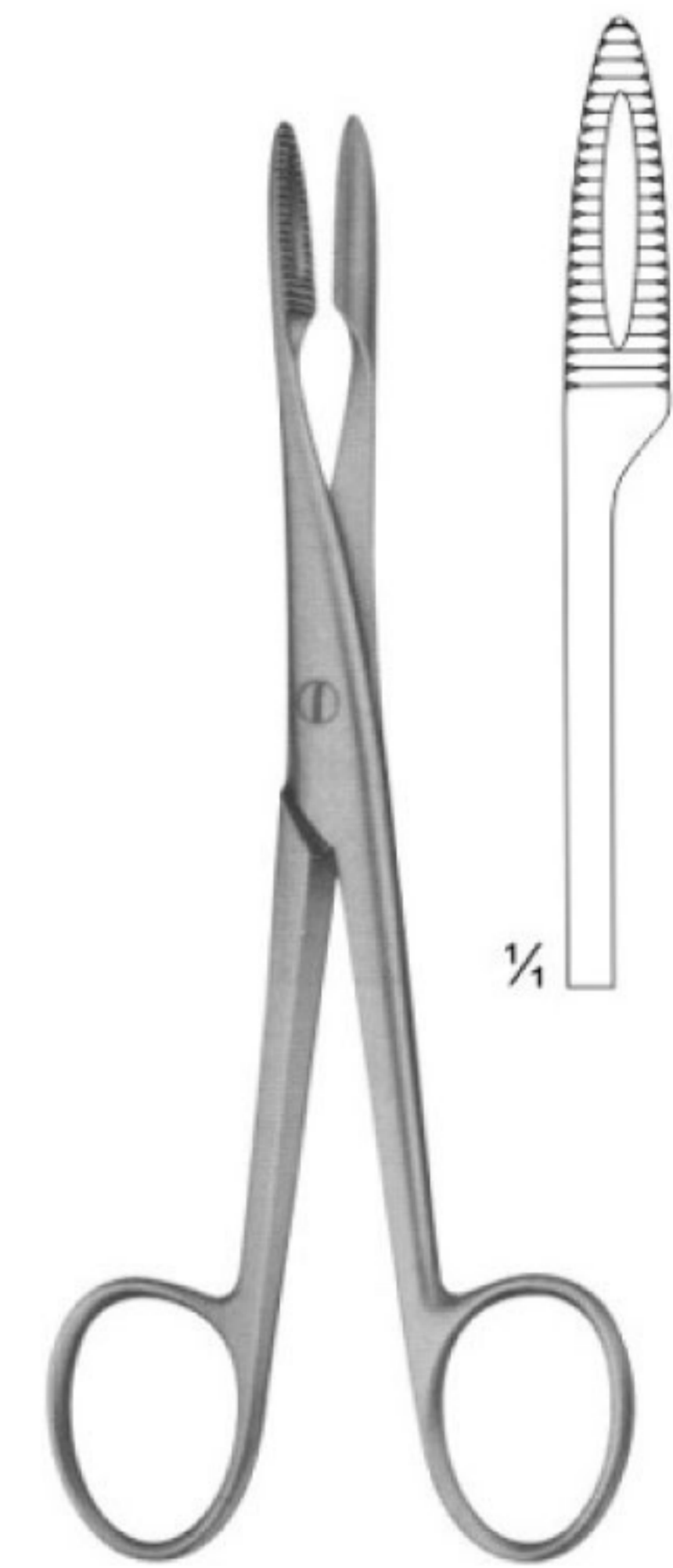

Without Ratchet 145 mm
MWD-2384
 Without Ratchet 145 mm

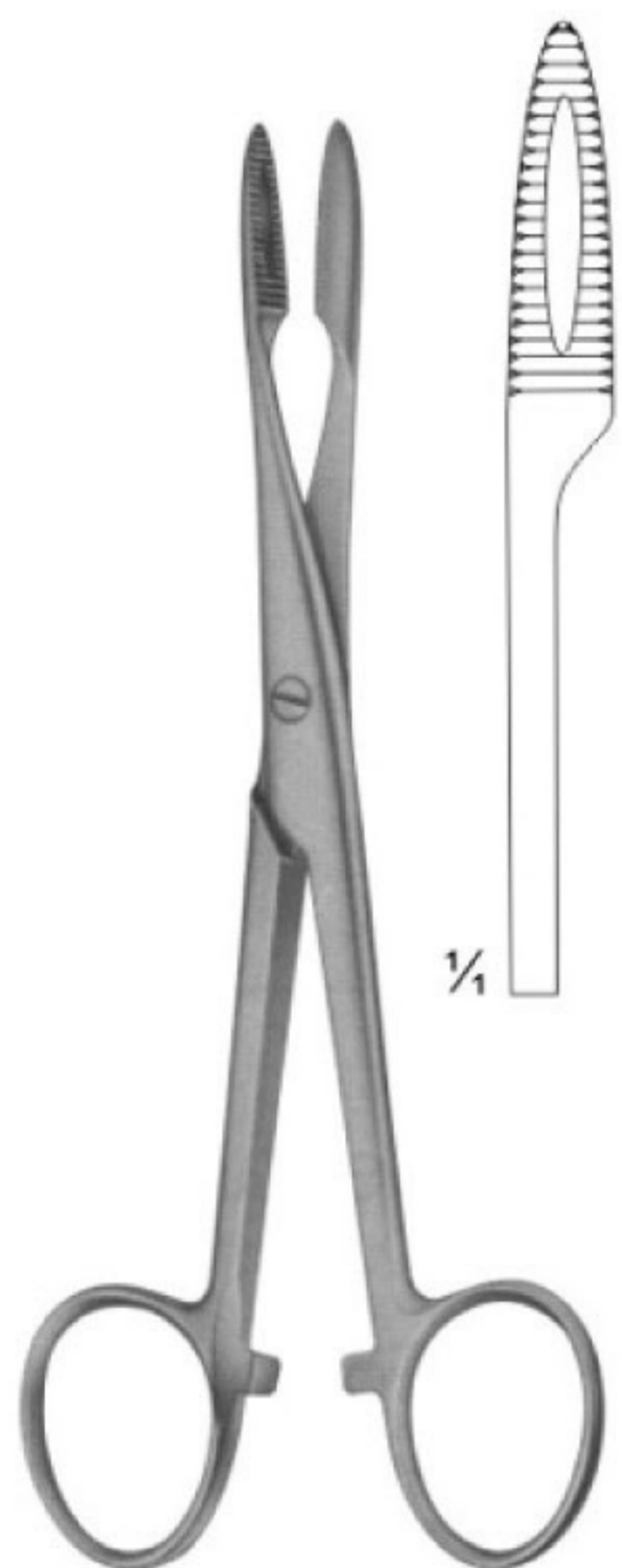

With Ratchet 145 mm
MWD-2385
 With Ratchet 145 mm

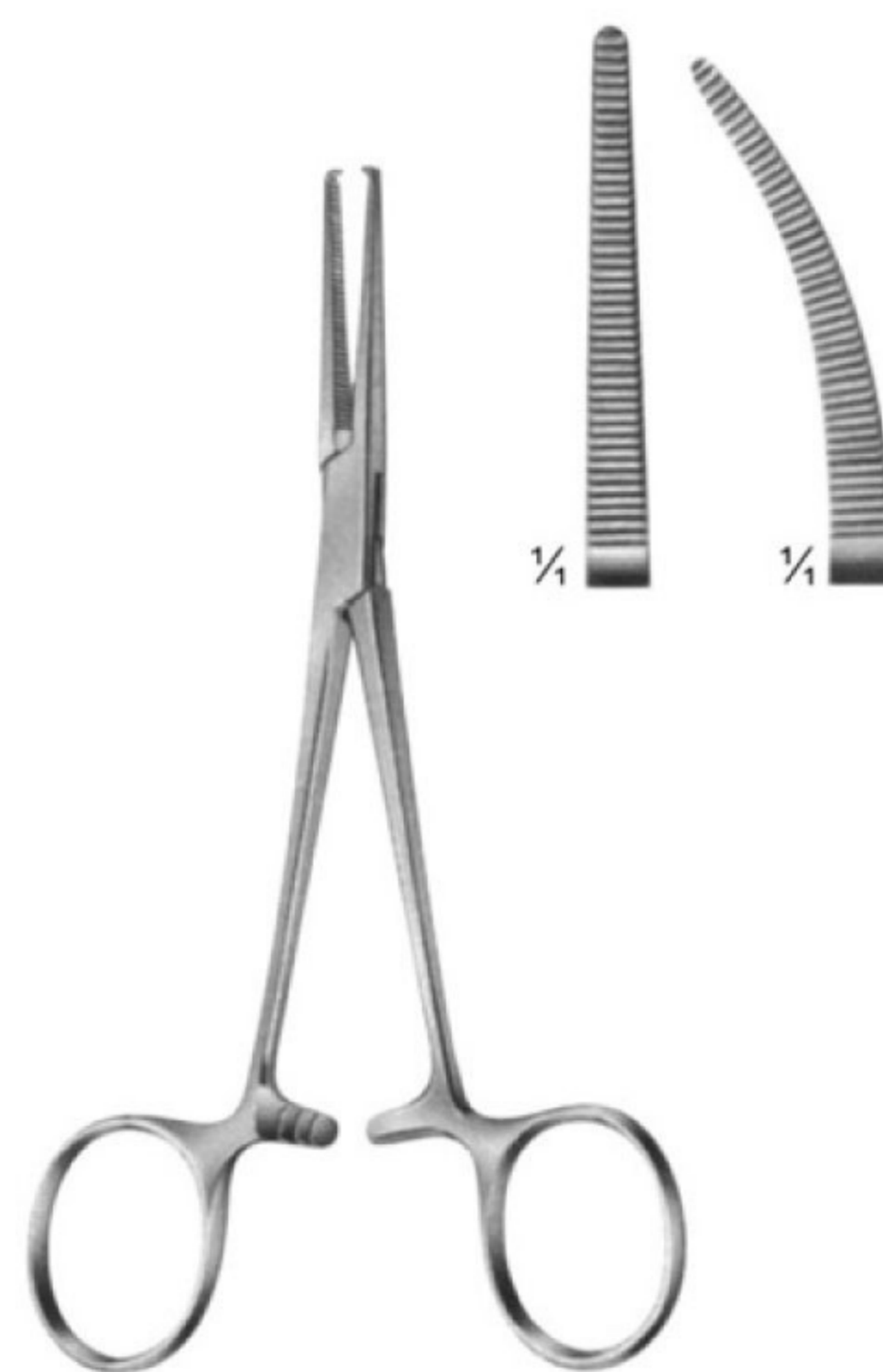

CRILE 140 mm
MWD-2386
 CRILE 140 mm



PEAN Slender type
MWD-2387
 PEAN Slender type

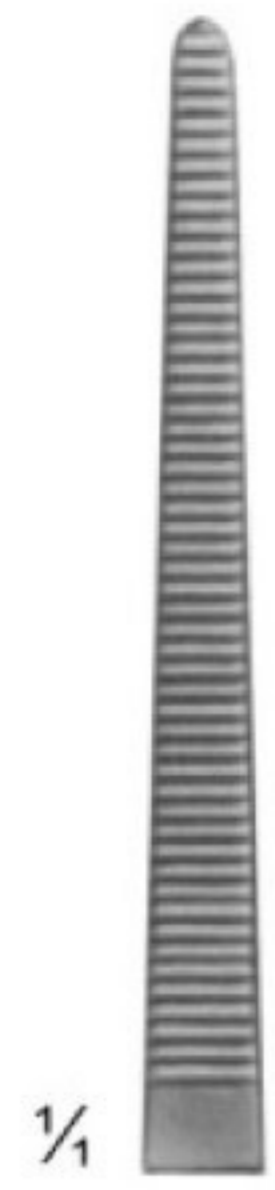

130 mm
MWD-2388
130 mm

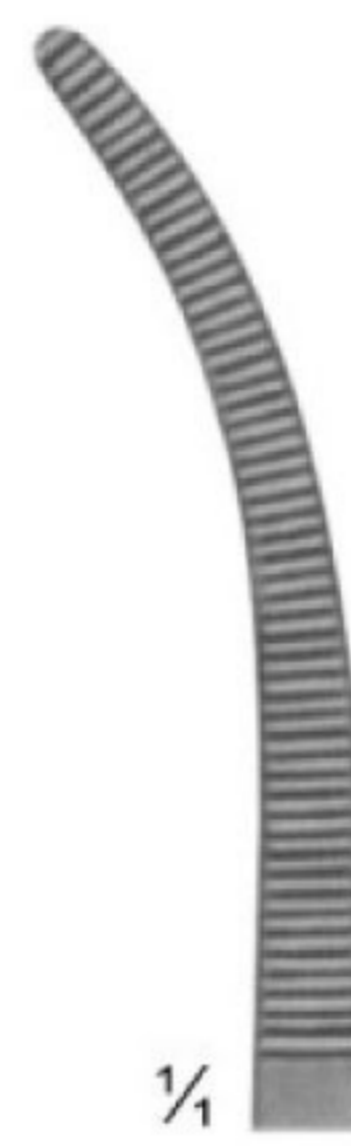

140 mm
MWD-2389
140 mm



SPENCER-WELLS
MWD-2390
SPENCER-WELLS



150 mm
MWD-2391
150 mm



130 mm
MWD-2392
130 mm



150 mm
MWD-2393
150 mm



BABY-ALLIS 5", Straight 4x5 teeth extra delicate
MWD-2394

BABY-ALLIS 5", Straight 4x5 teeth extra delicate

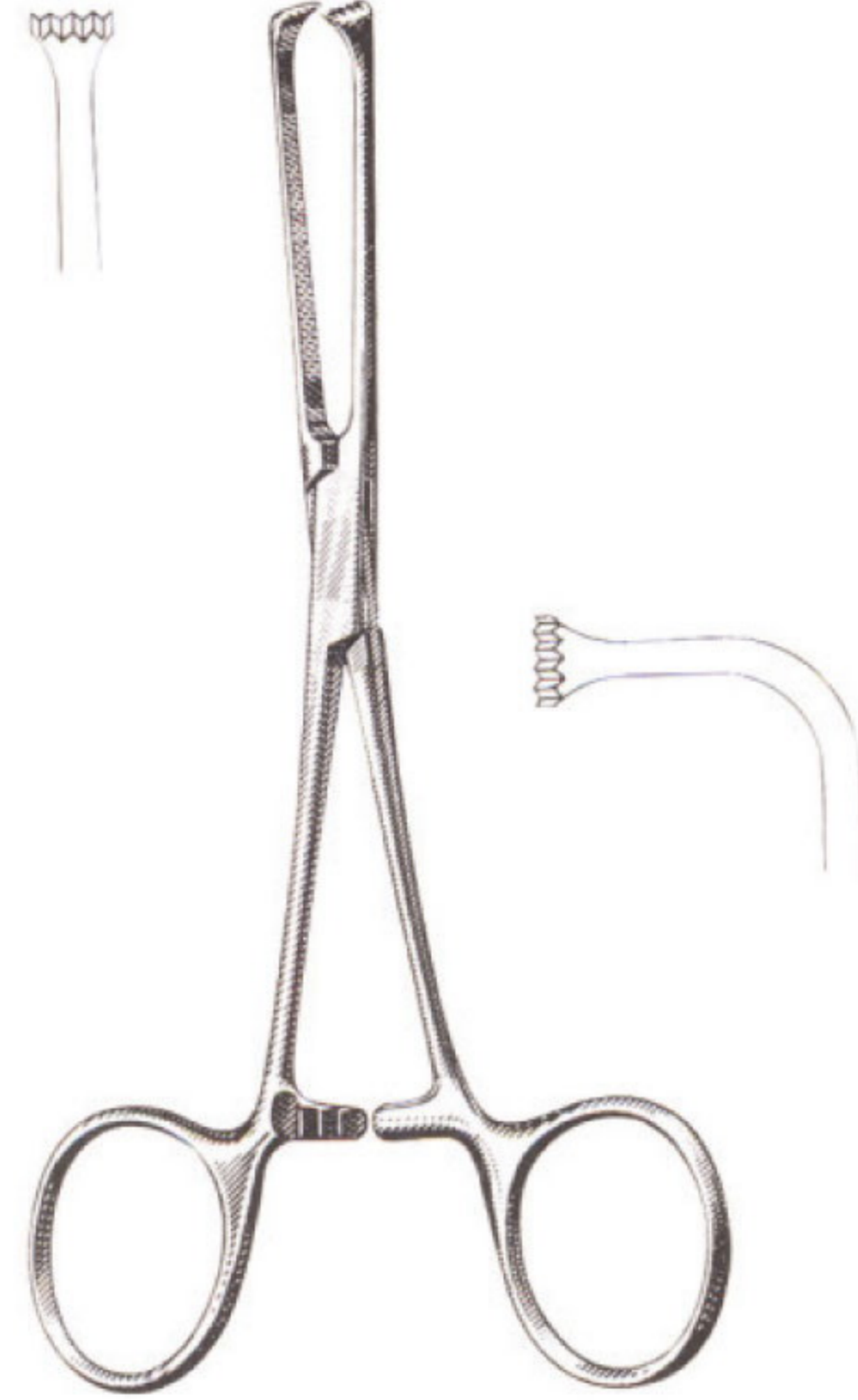

ALLIS 6", Straight 4x5 teeth extra delicate
MWD-2395

ALLIS 6", Straight 4x5 teeth extra delicate



ALLIS 6", Straight 4x5 teeth extra delicate
MWD-2396

ALLIS 6", Straight 4x5 teeth extra delicate

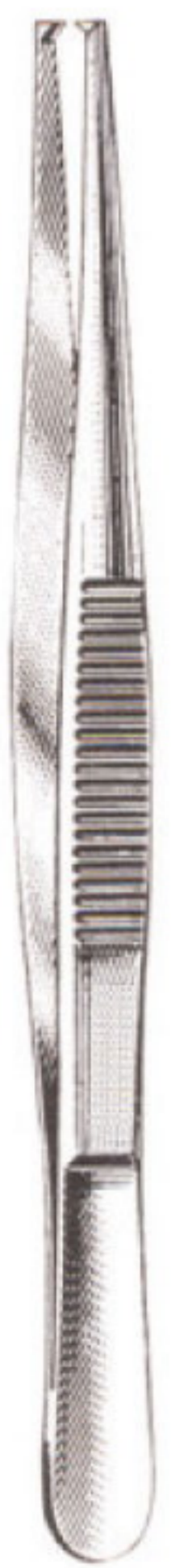

1x2 teeth 6"
MWD-2397
 1x2 teeth 6"



SEMKIN 6", Straight, 1x2 teeth
MWD-2398

SEMKIN 6", Straight, 1x2 teeth



ADSON 4 3/4" 1x2 teeth
MWD-2399

ADSON 4 3/4" 1x2 teeth



BROWN-ADSON 4 3/4" 7x7 teeth
MWD-2400
 BROWN-ADSON 4 3/4" 7x7 teeth



BROWN 6" 8x8 teeth
MWD-2401
 BROWN 6" 8x8 teeth



RUSSIAN 6" 8x8 teeth
MWD-2402
 RUSSIAN 6" 8x8 teeth



HALSTED-MOSQUITO Straight, Curved, 5"
MWD-2404
 HALSTED-MOSQUITO Straight, Curved, 5"



HALSTED-MOSQUITO Straight, Curved, 5" 1x2 teeth
MWD-2405
 HALSTED-MOSQUITO Straight, Curved, 5" 1x2 teeth



HALSTED-MOSQUITO Jaws 45 Angled on Flat, 5" Extra Delicate
MWD-2406
 HALSTED-MOSQUITO Jaws 45 Angled on Flat, 5" Extra Delicate



KELLY 5 1/2", Straight
MWD-2407
 KELLY 5 1/2", Straight



JONES 3 1/2"
MWD-2408
 JONES 3 1/2"



BACKHAUS 3 1/2"
MWD-2409
 BACKHAUS 3 1/2"



BACKHAUS 5 1/4"
MWD-2410
 BACKHAUS 5 1/4"



LORNA Non Perforated 3 1/2"
MWD-2411
 LORNA Non Perforated 3 1/2"

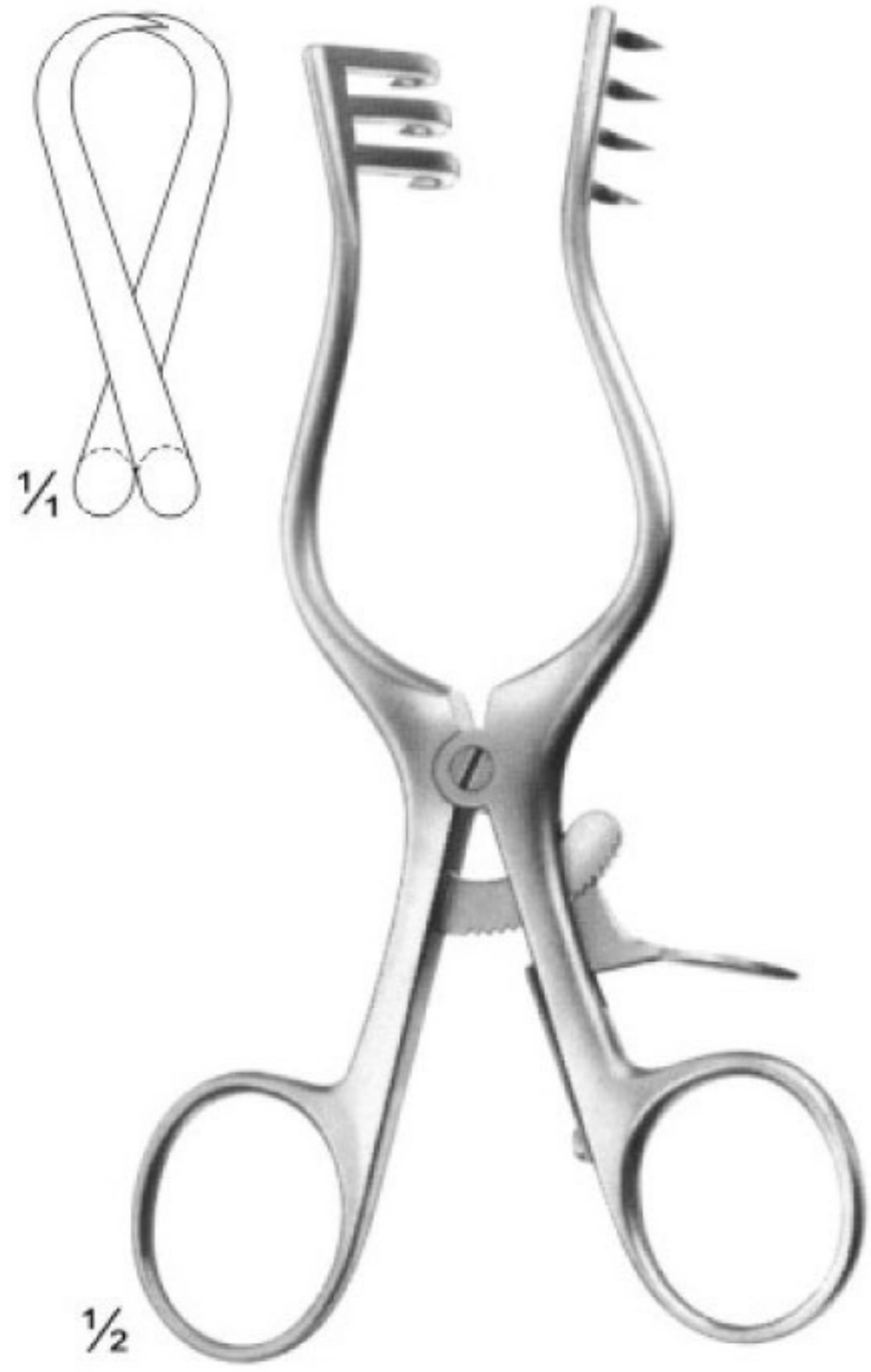

WEITLANER Sharp 130 mm
MWD-2412
 WEITLANER Sharp 130 mm

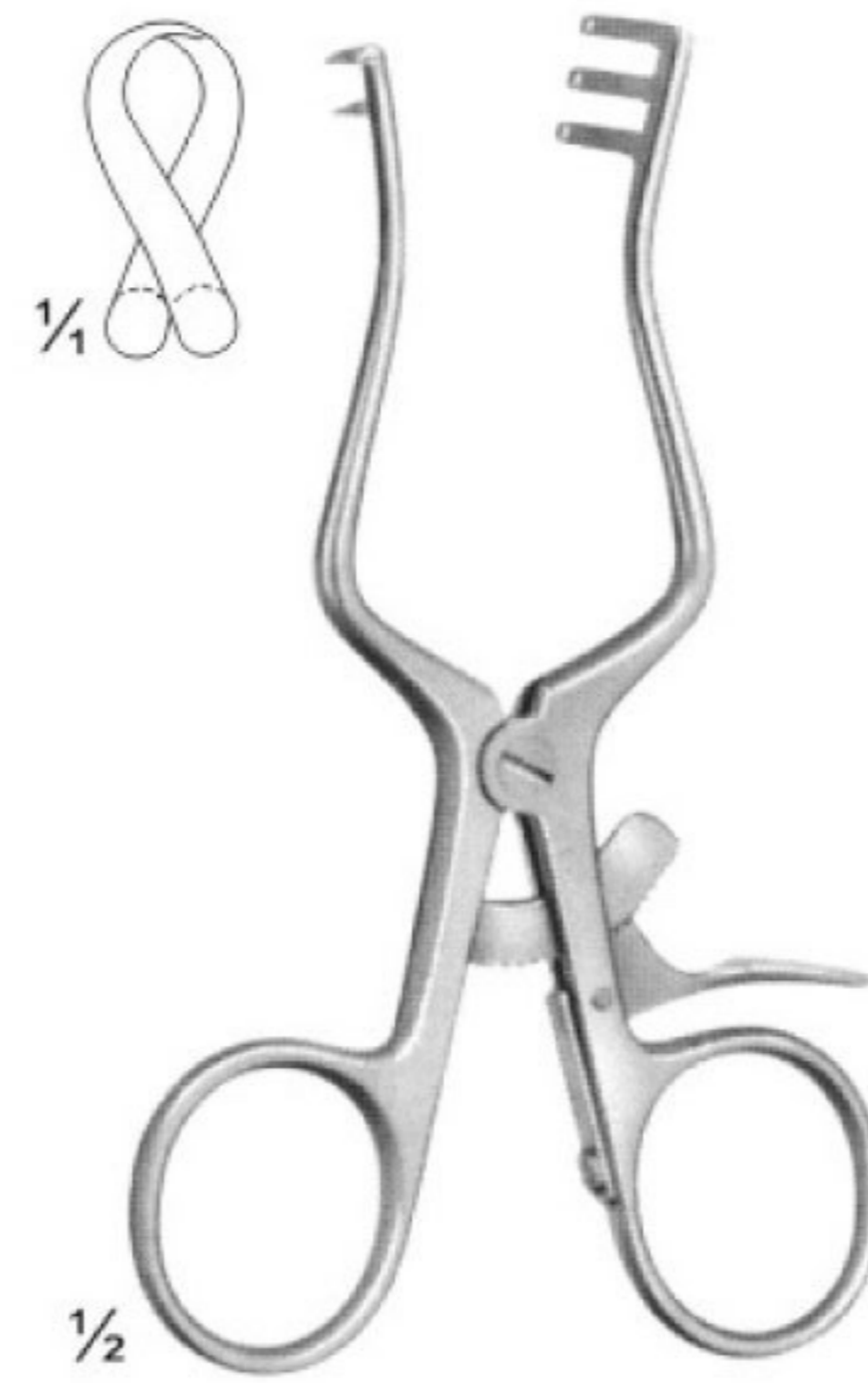

WEITLANER Sharp 110 mm
MWD-2413
 WEITLANER Sharp 110 mm

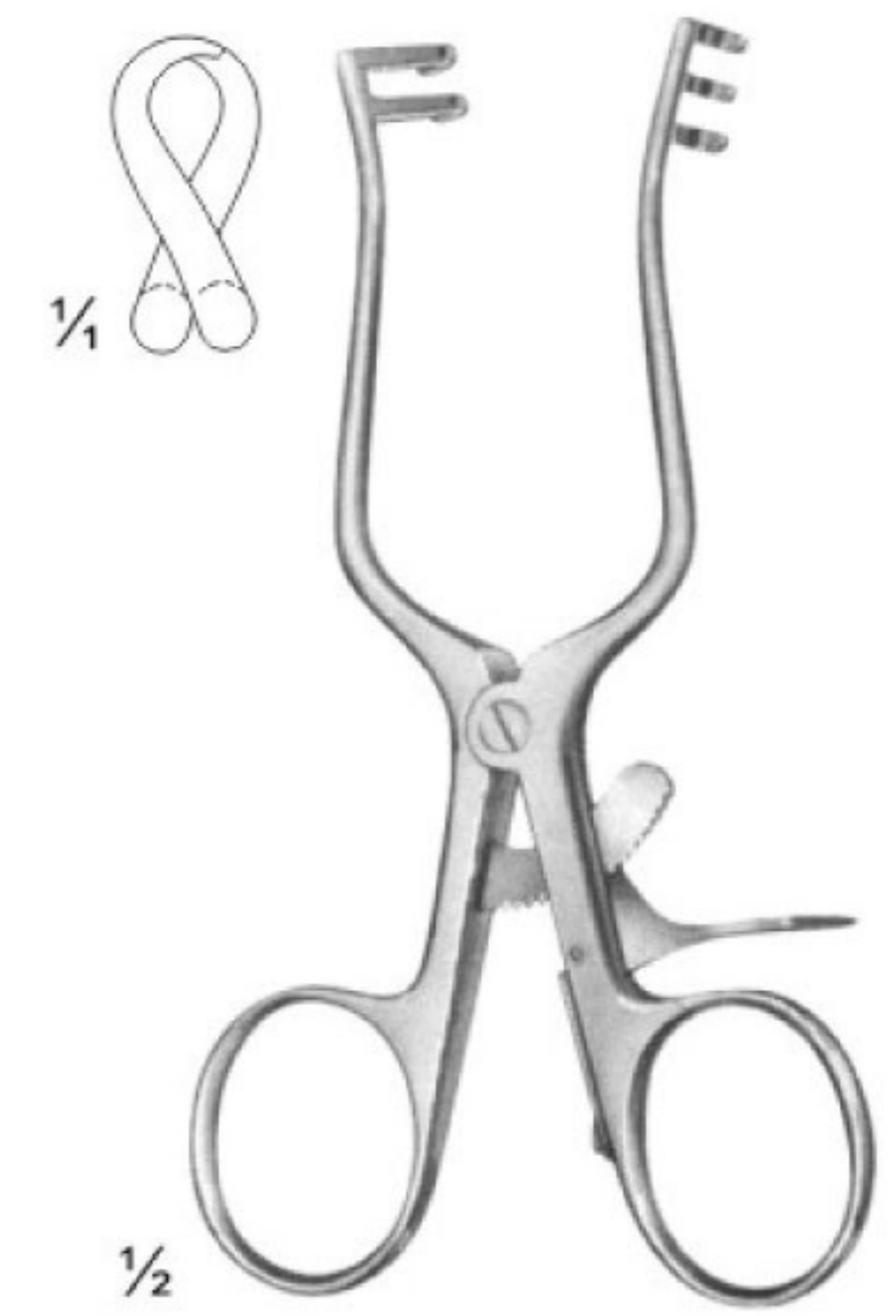

WEITLANER Semi-Sharp 110 mm
MWD-2414
 WEITLANER Semi-Sharp 110 mm

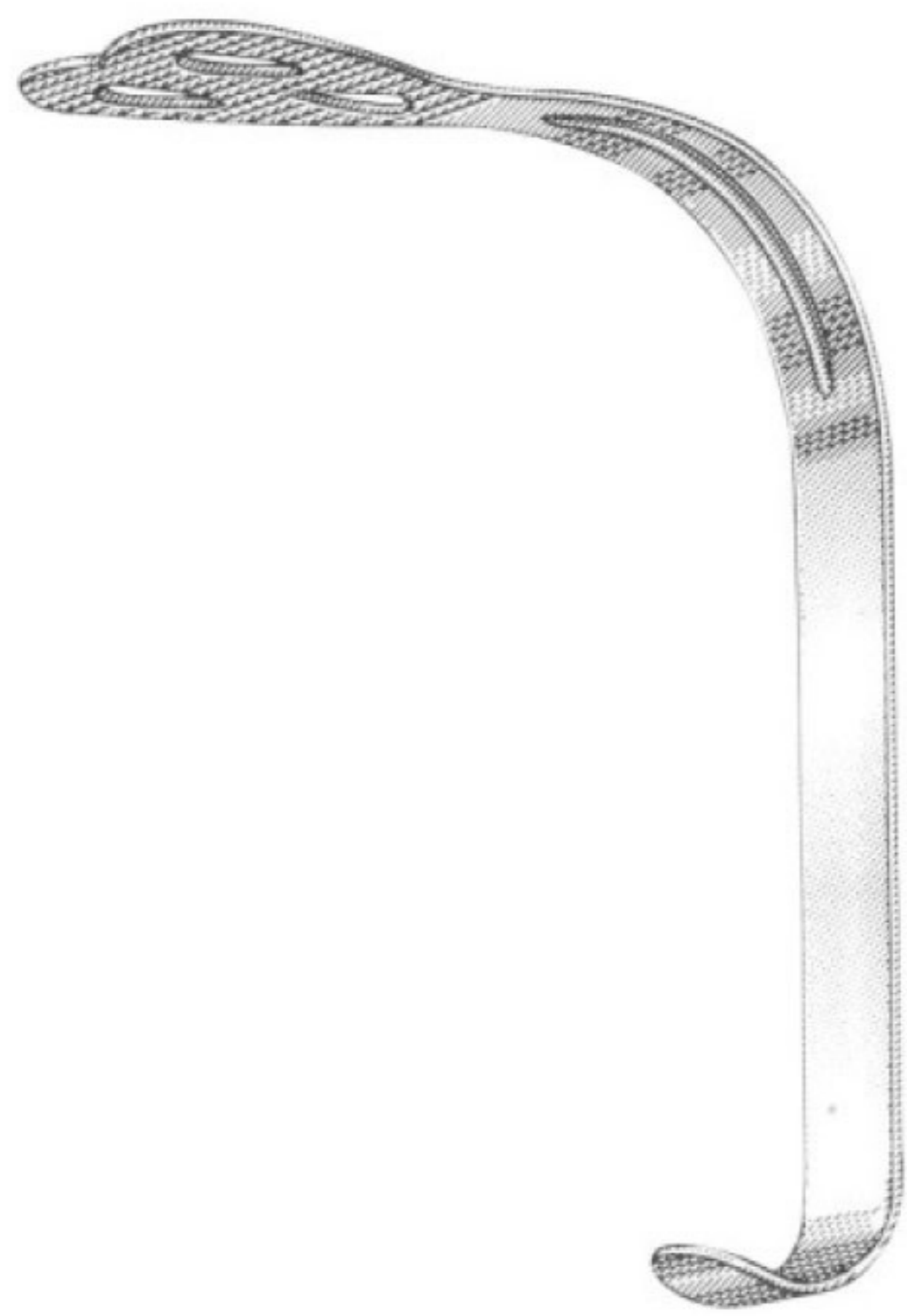

WIEDER Tongue Depressor, Small Blade
28 mm Wide Serrated
MWD-2415
 WIEDER Tongue Depressor, Small Blade 28
 mm Wide Serrated

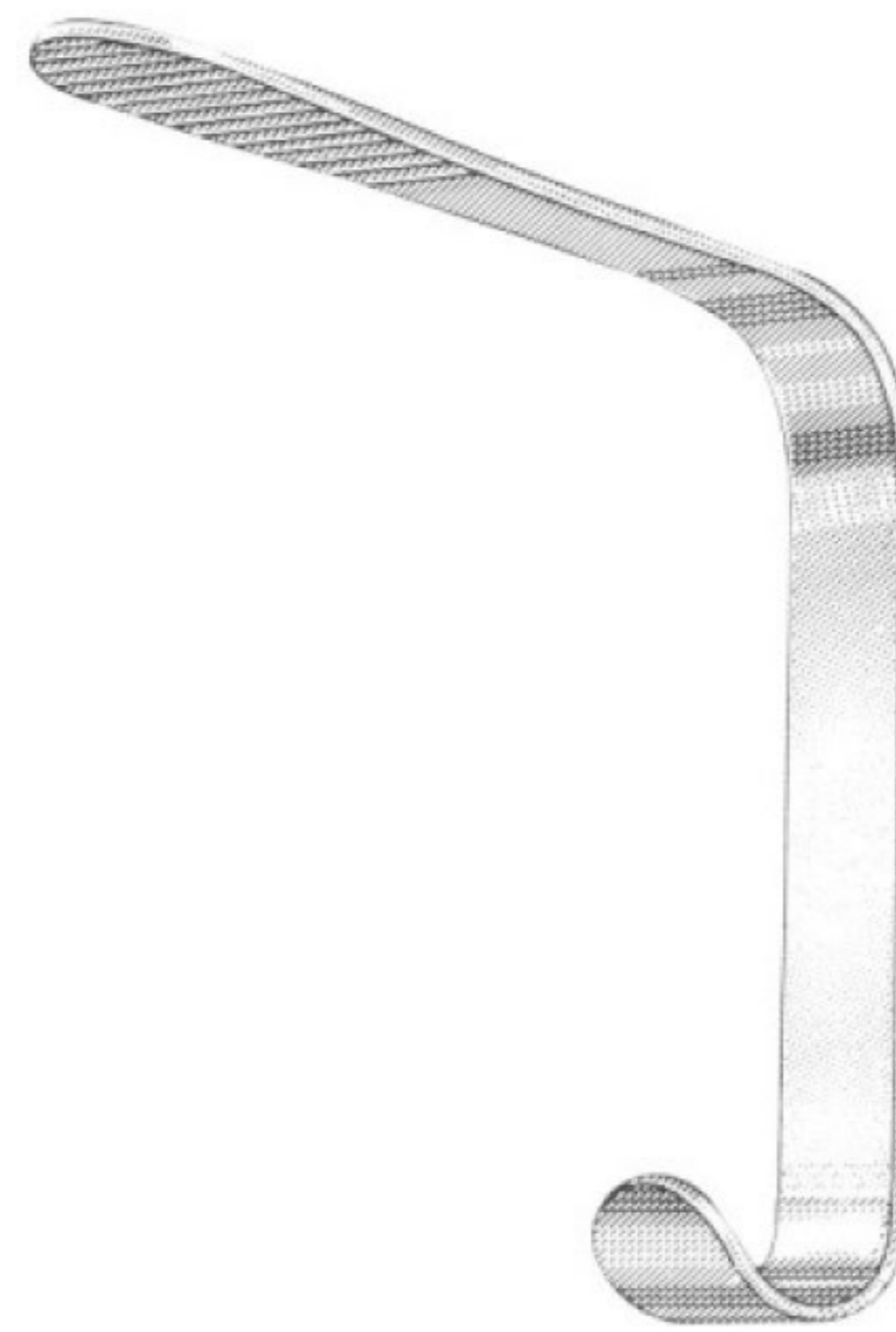

ANDREWS Tongue Depressor, Serrated
Blade 21 mm wide
MWD-2416
 ANDREWS Tongue Depressor, Serrated
 Blade 21 mm wide



MOLT Pediatric
MWD-2417
 MOLT Pediatric

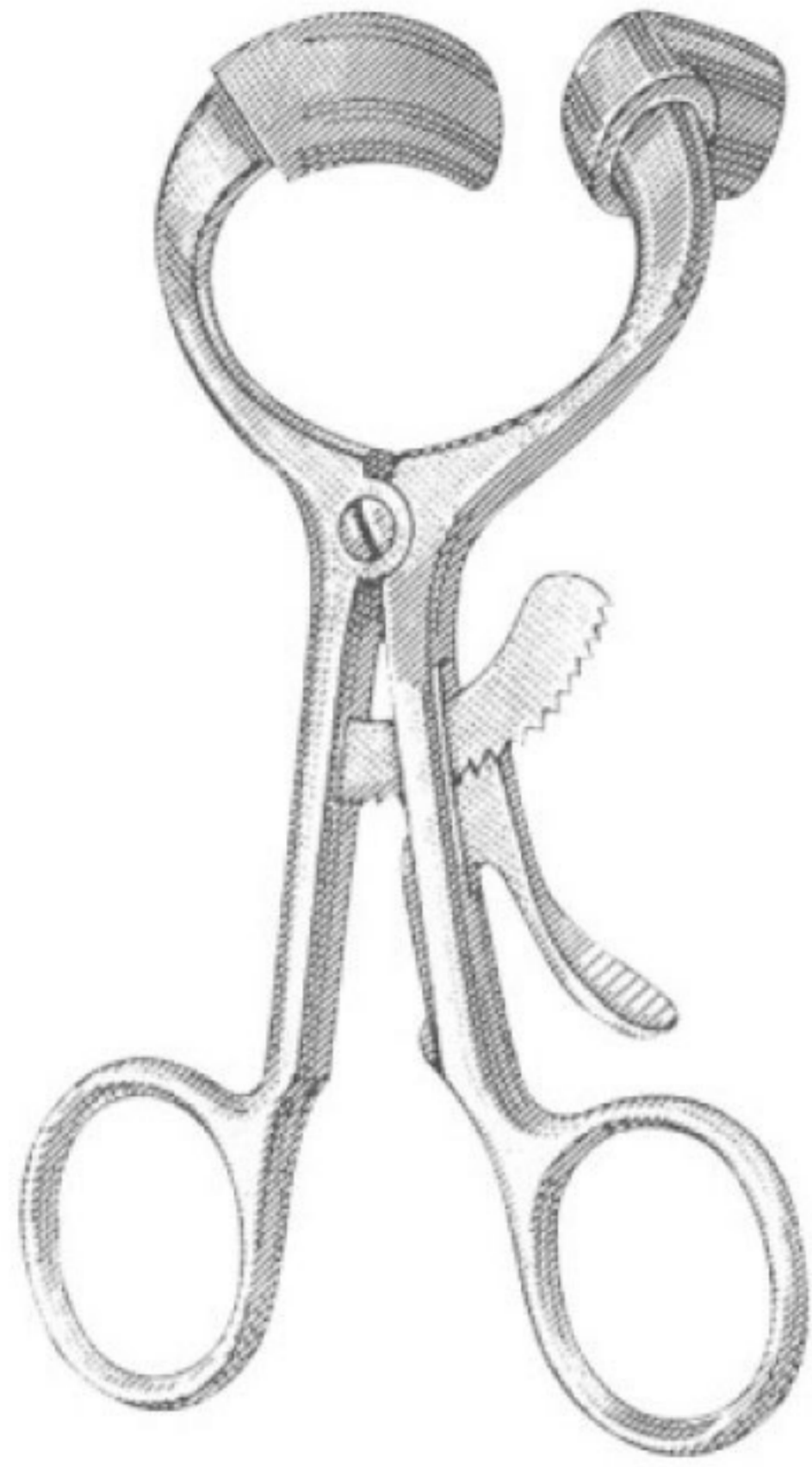

MOLT Child
MWD-2418
 MOLT Child

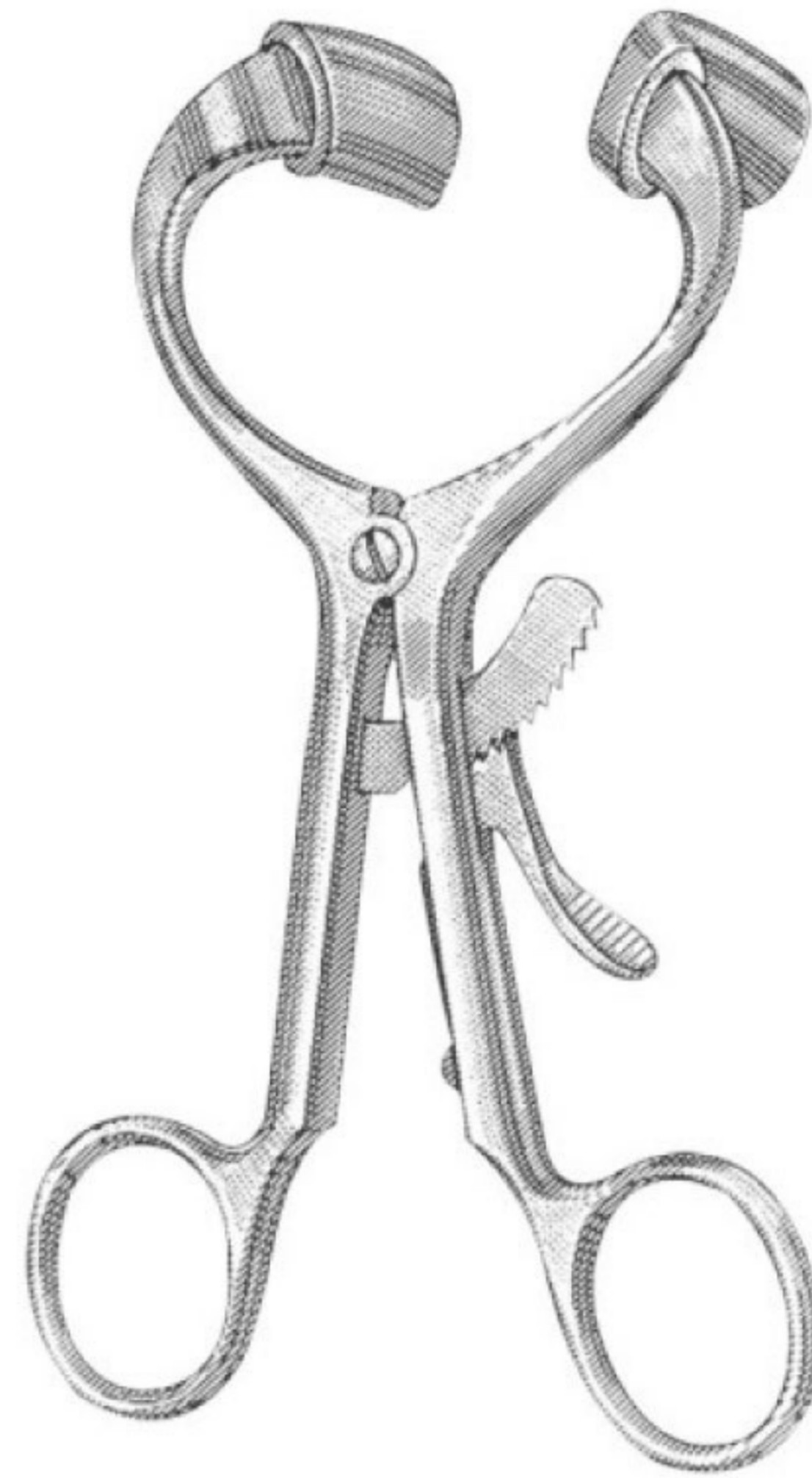

MOLT Adult
MWD-2419
 MOLT Adult

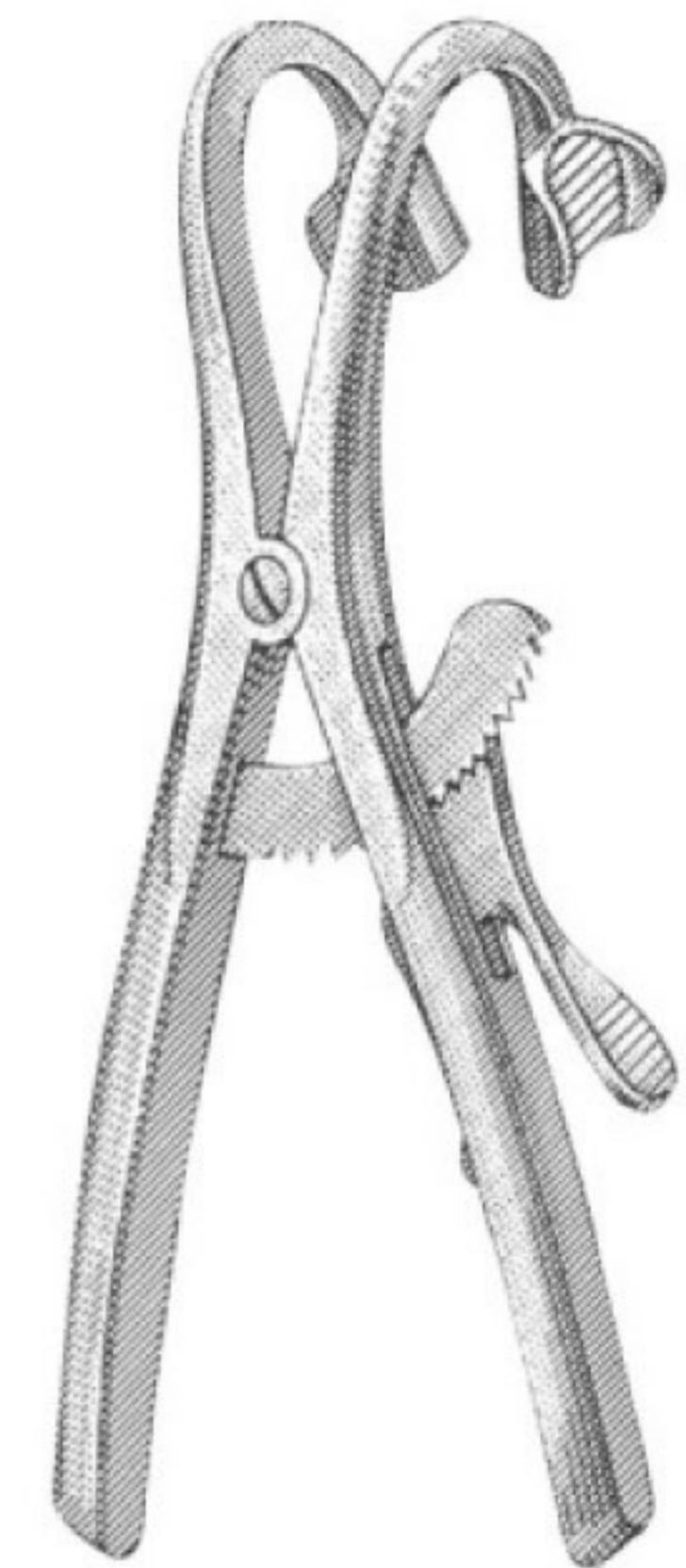

DENHART
MWD-2420
 DENHART

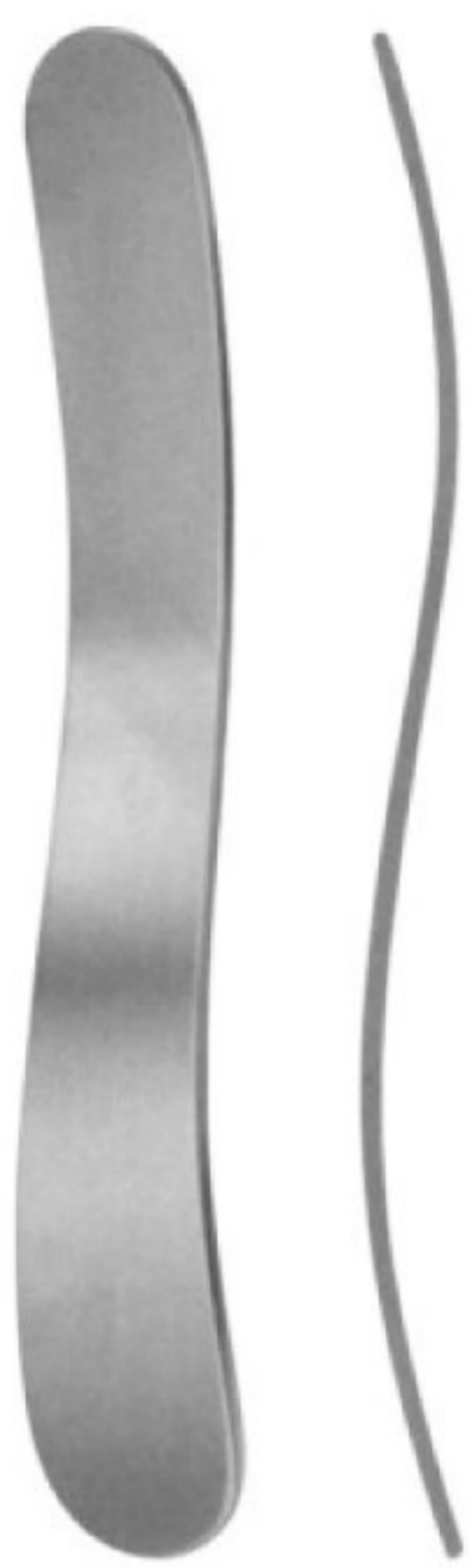

140 mm
MWD-2421
 140 mm

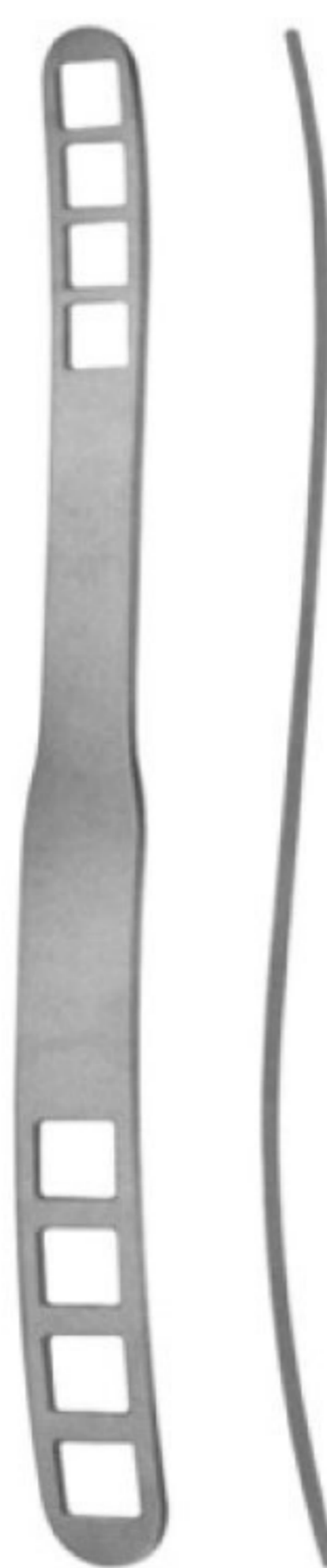

BRUENINGS 190 mm
MWD-2422
 BRUENINGS 190 mm



MWD-2423



MWD-2424



MWD-2425



MWD-2426



MWD-2427



MWD-2428



MWD-2429



LANGENBECK 210 mm
MWD-2430
 LANGENBECK 210 mm



KOCHER-LANGENBECK 215 mm
MWD-2431
 KOCHER-LANGENBECK 215 mm



BUCHS 205 mm
MWD-2432
 BUCHS



KOCHER 230 mm
MWD-2433
 KOCHER 230 mm



15 x 15 mm 220 mm
MWD-2434
 15 x 15 mm 220 mm



20 x 22 mm 215 mm
MWD-2435
 22 mm 215 mm



MIDDELDORPF
MWD-2436
MIDDELDORPF



28 x 28 mm 235 mm
MWD-2437
28 x 28 mm 235 mm



KOCHER 230 mm
MWD-2438
KOCHER 230 mm



COLLIN 150 mm
MWD-2439
COLLIN 150 mm



ROUX Set 165 mm
MWD-2440
ROUX Set 165 mm



3 sharp prongs
MWD-2441
3 sharp prongs



2 sharp prongs 6"
MWD-2442
 2 sharp prongs 6"



2 sharp prongs 6"
MWD-2443
 2 sharp prongs 6"

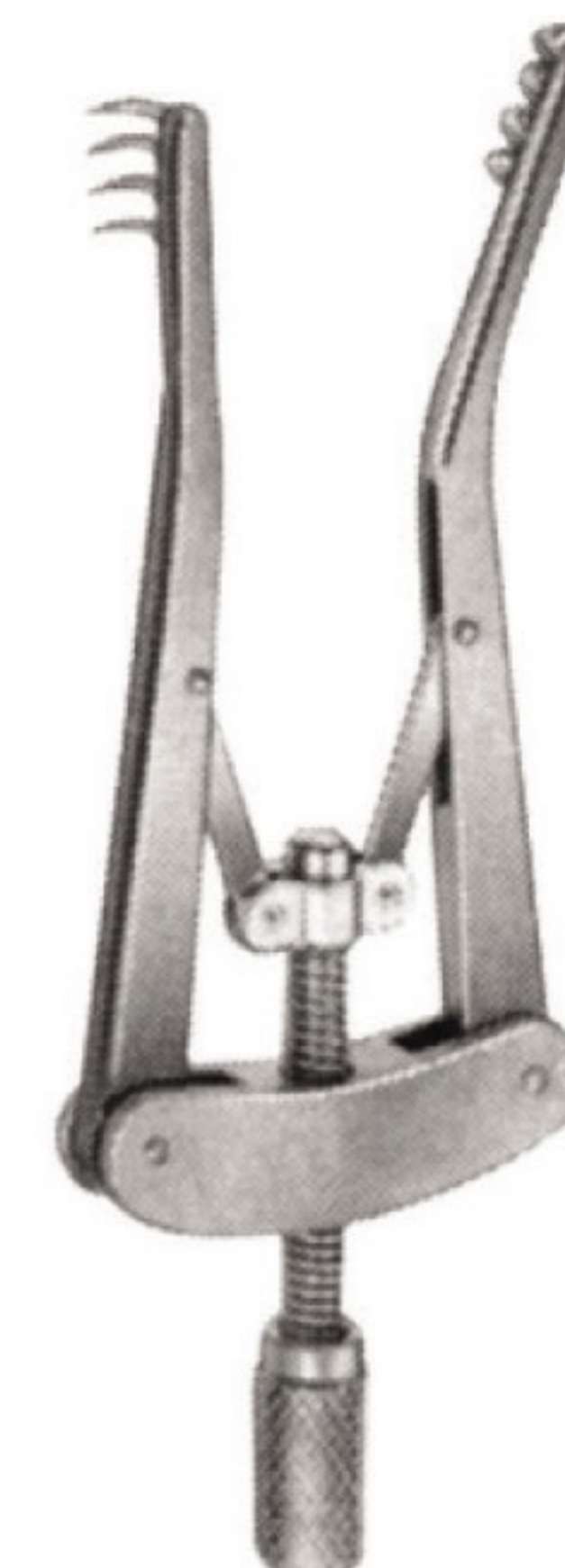

ALM 70 mm
MWD-2445
 ALM 70 mm



SENN 3 sharp prongs 6 3/8"
MWD-2446
 SENN 3 sharp prongs 6 3/8"



TOENNIS Dura Retractor 150mm
MWD-2447
 TOENNIS Dura Retractor 150mm



JOSEPH 165 mm
MWD-2448
 JOSEPH 165 mm



GILLIES 180 mm
MWD-2449
GILLIES 180 mm

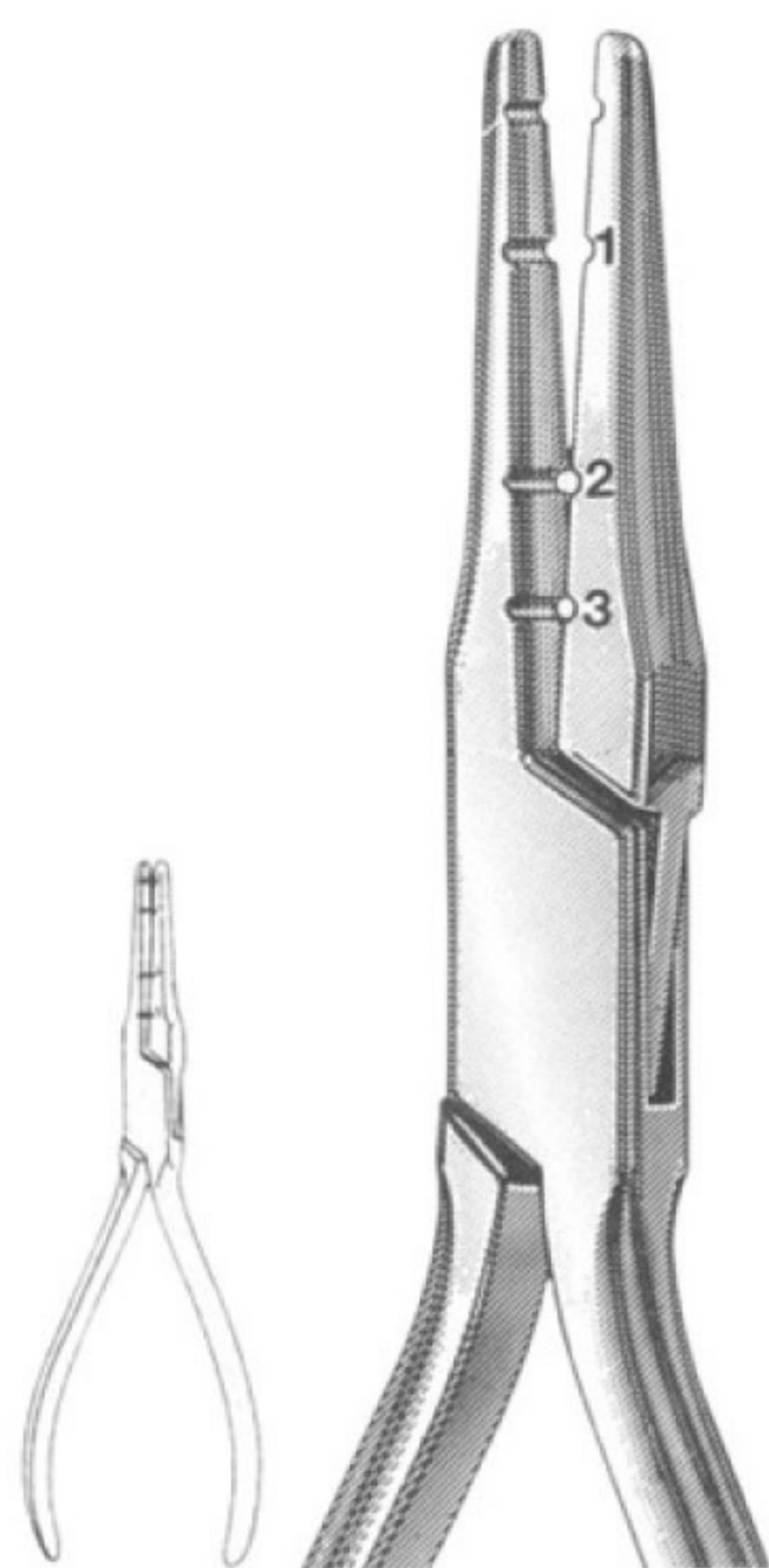

Fig. 101 Wire Bending
MWD-2450
 Fig. 101 Wire Bending

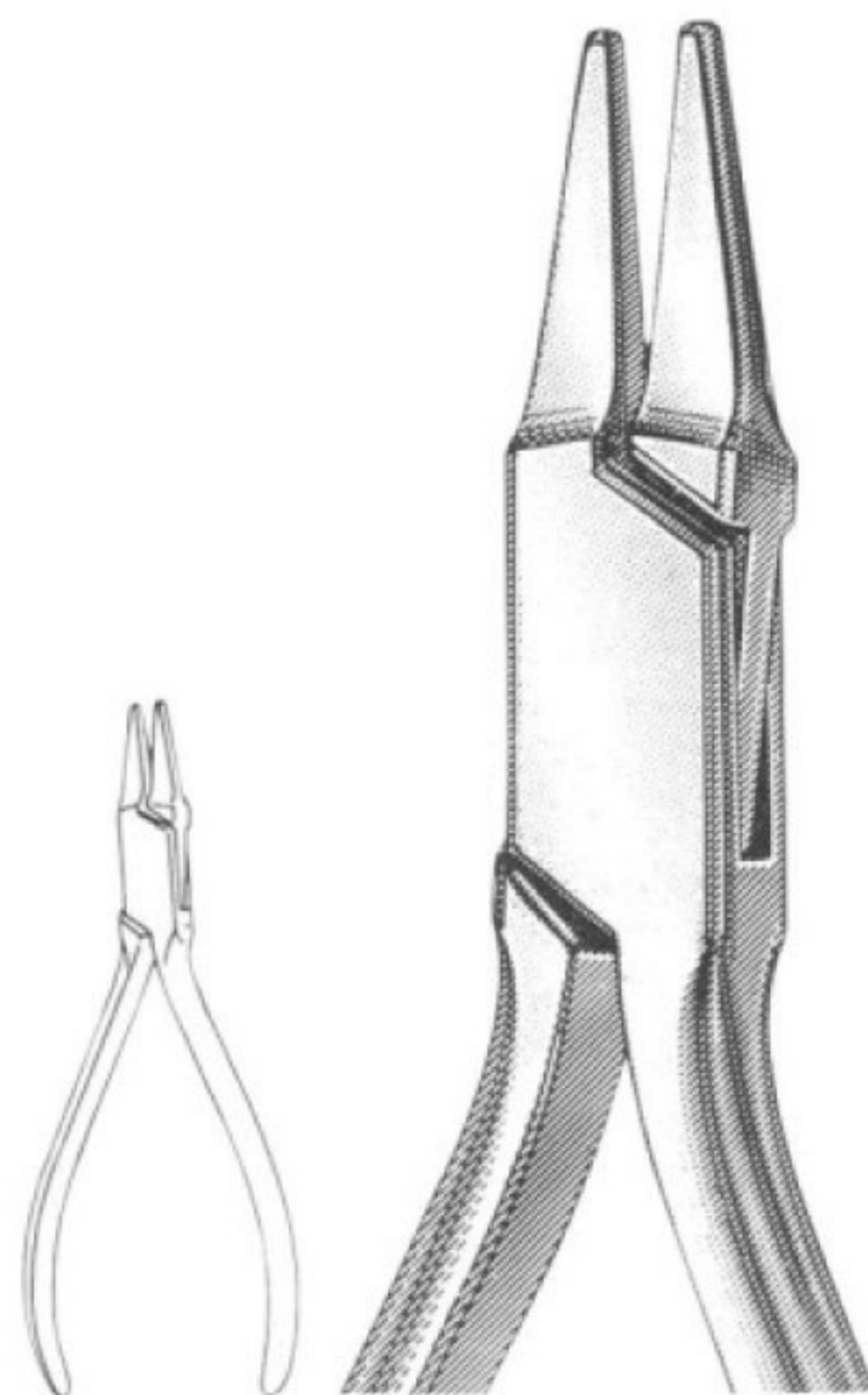

Fig. 118 PEESO Collar
MWD-2451
 Fig. 118 PEESO Collar

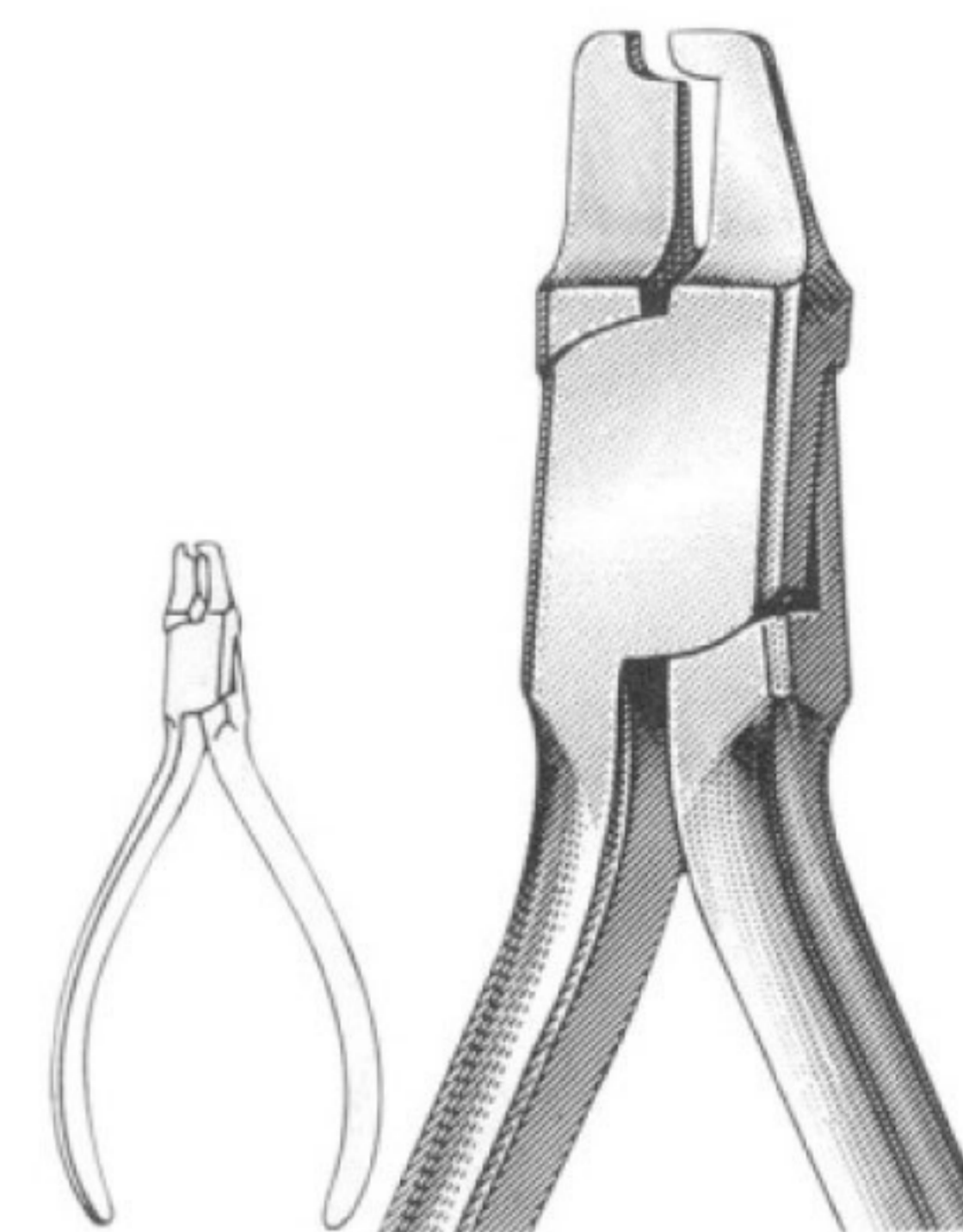
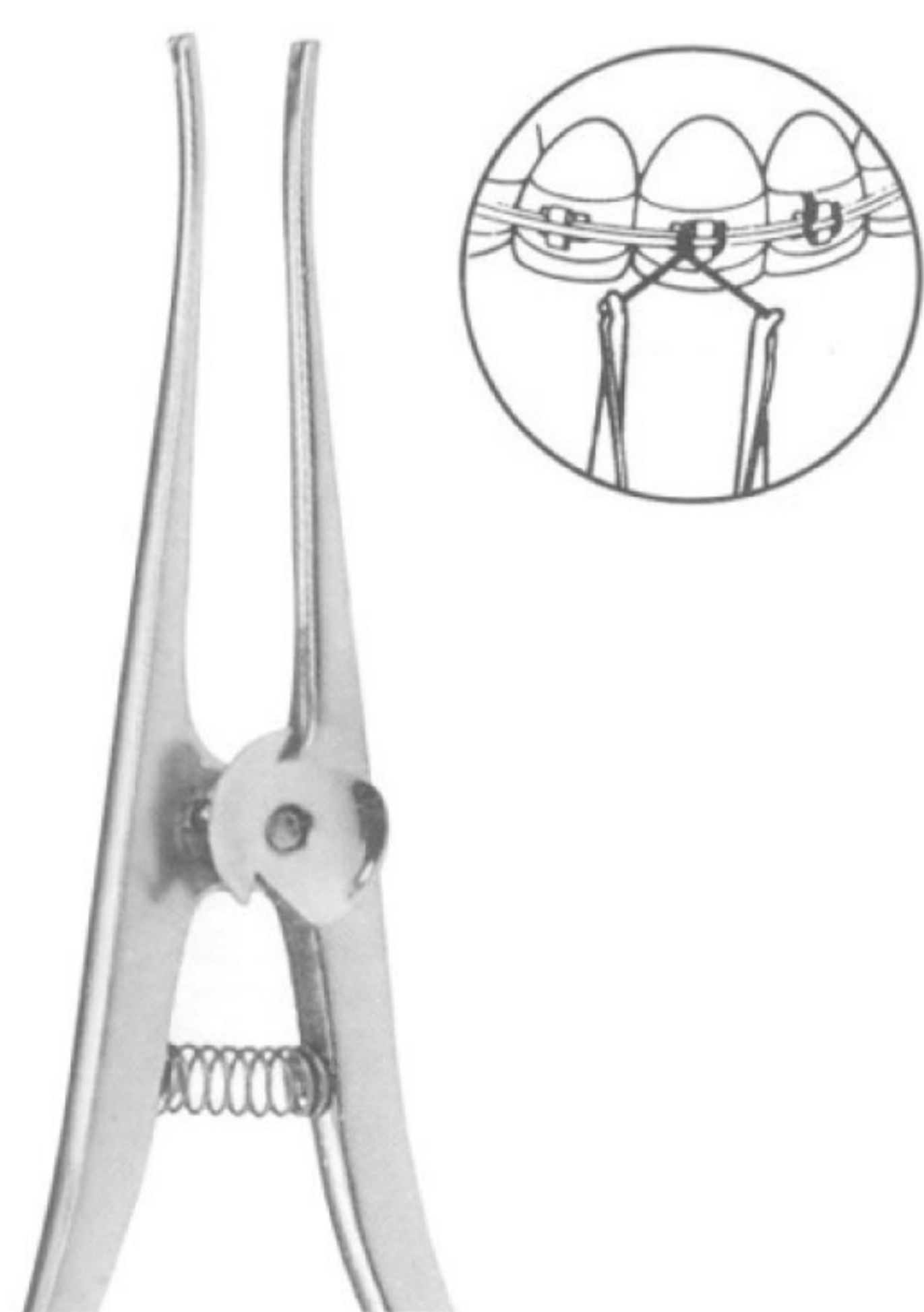
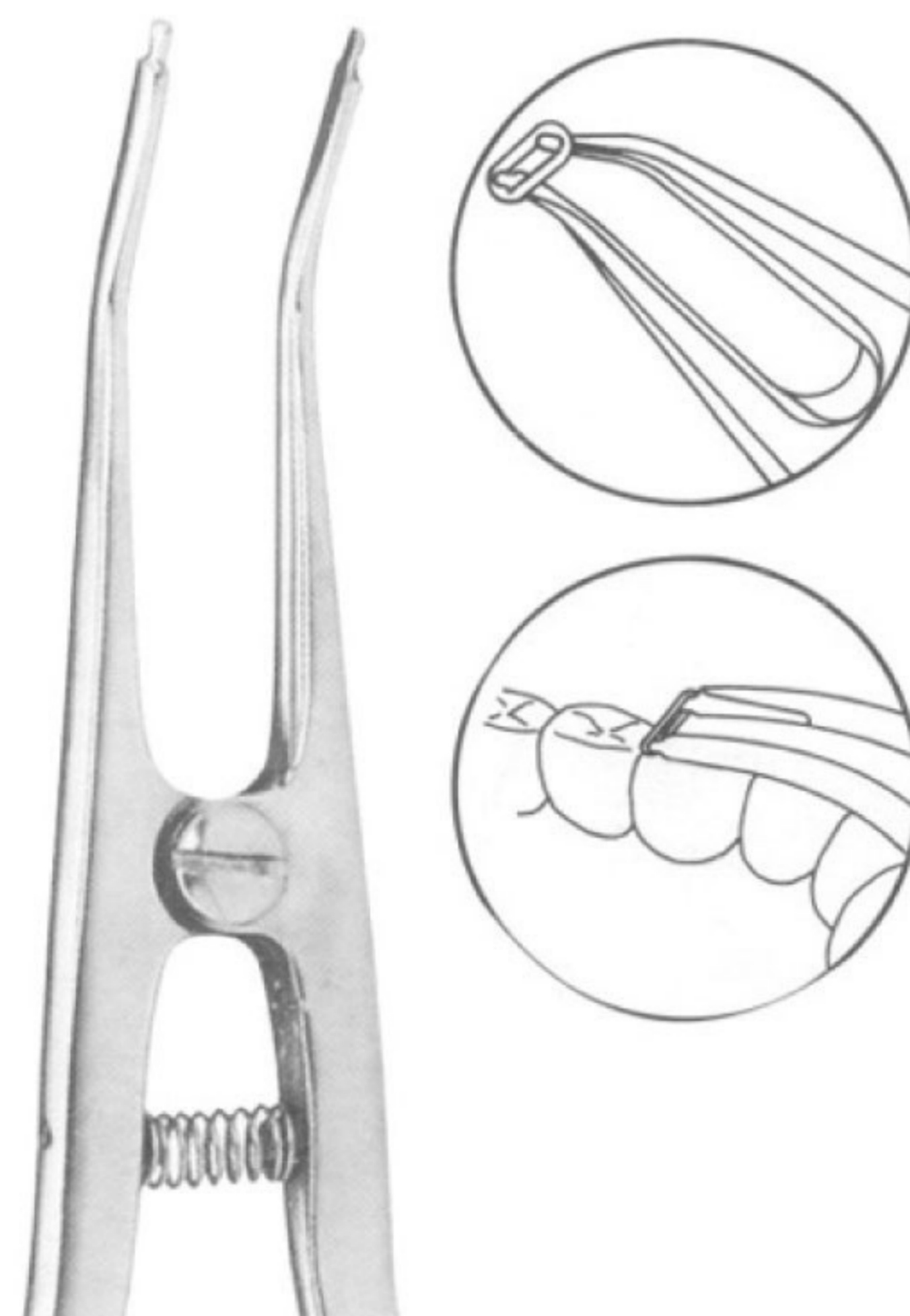

Fig. 417 Crown Shell
MWD-2452
 Fig. 417 Crown Shell



STEINER 150 mm Ligature Pliers
MWD-2453
 STEINER 150 mm Ligature Pliers



Separating Pliers Elastics 150 mm
MWD-2454
 Separating Pliers Elastics 150 mm

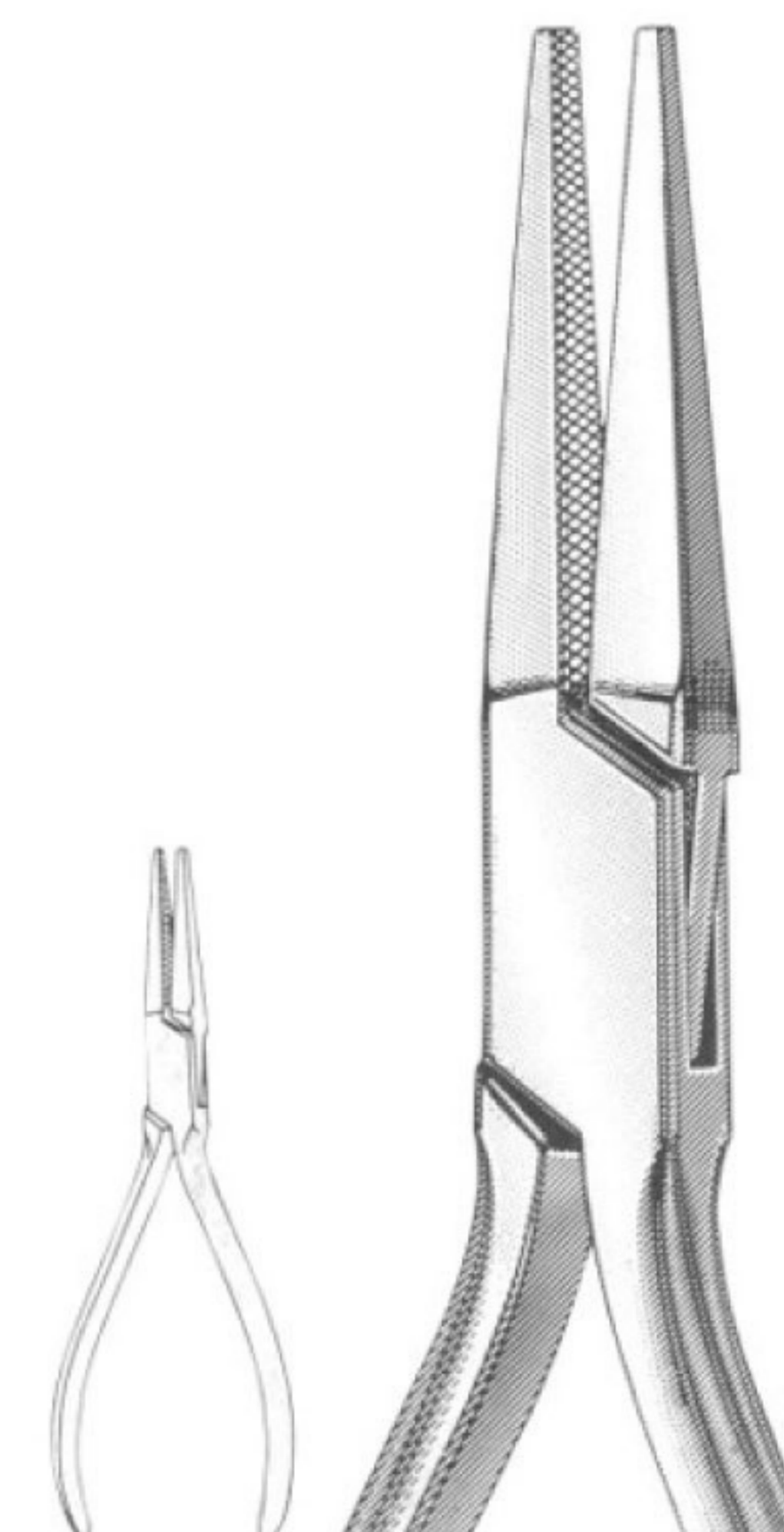

121-Lab & Office
MWD-2455
 121-Lab & Office



How Plier-Titanium Alloy With special coated beaks
MWD-2456

How Plier-Titanium Alloy With special coated beaks

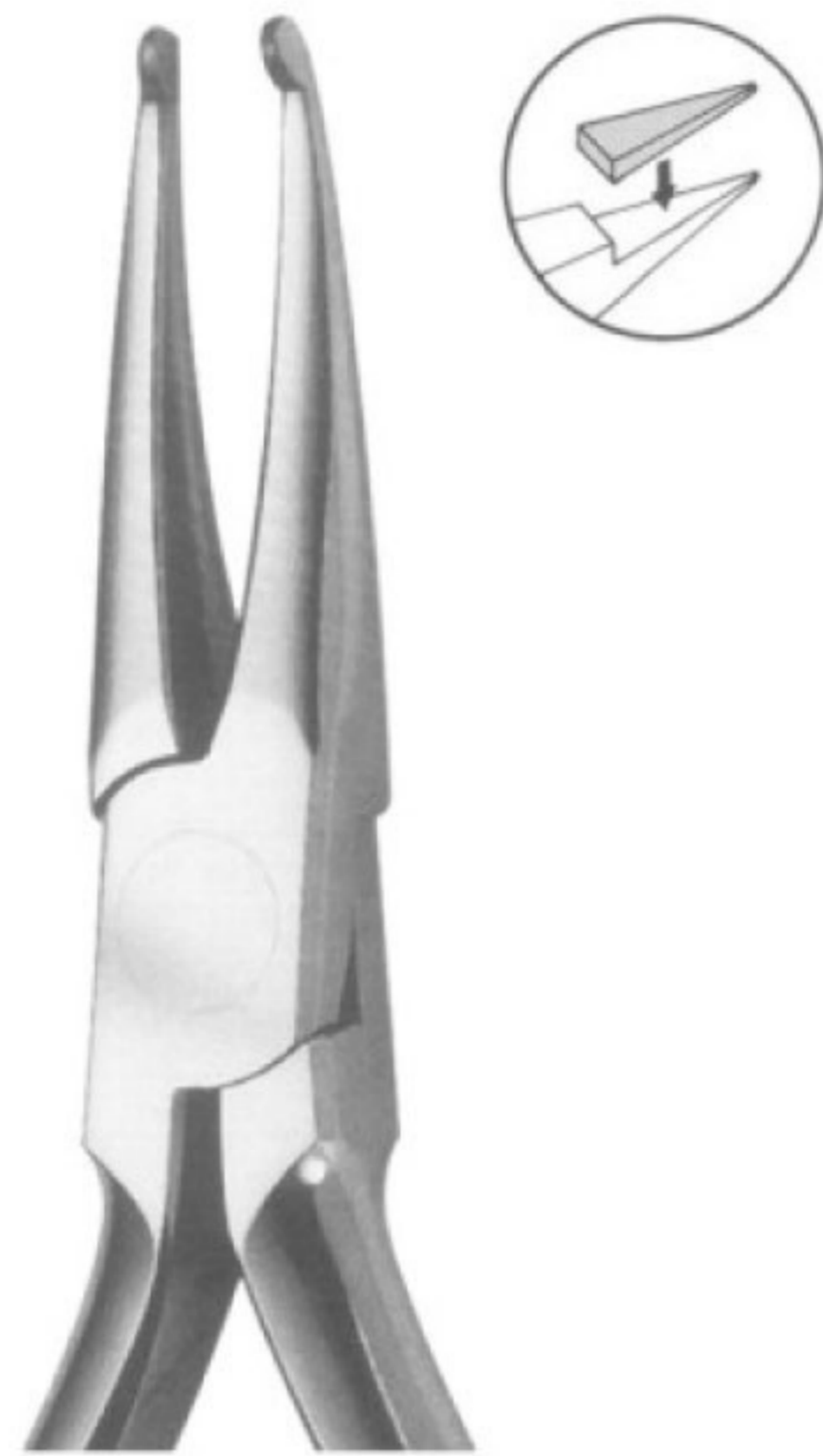

How Plier Tips are 1/8"(3.2mm) diameter
MWD-2457

How Plier Tips are 1/8"(3.2mm) diameter

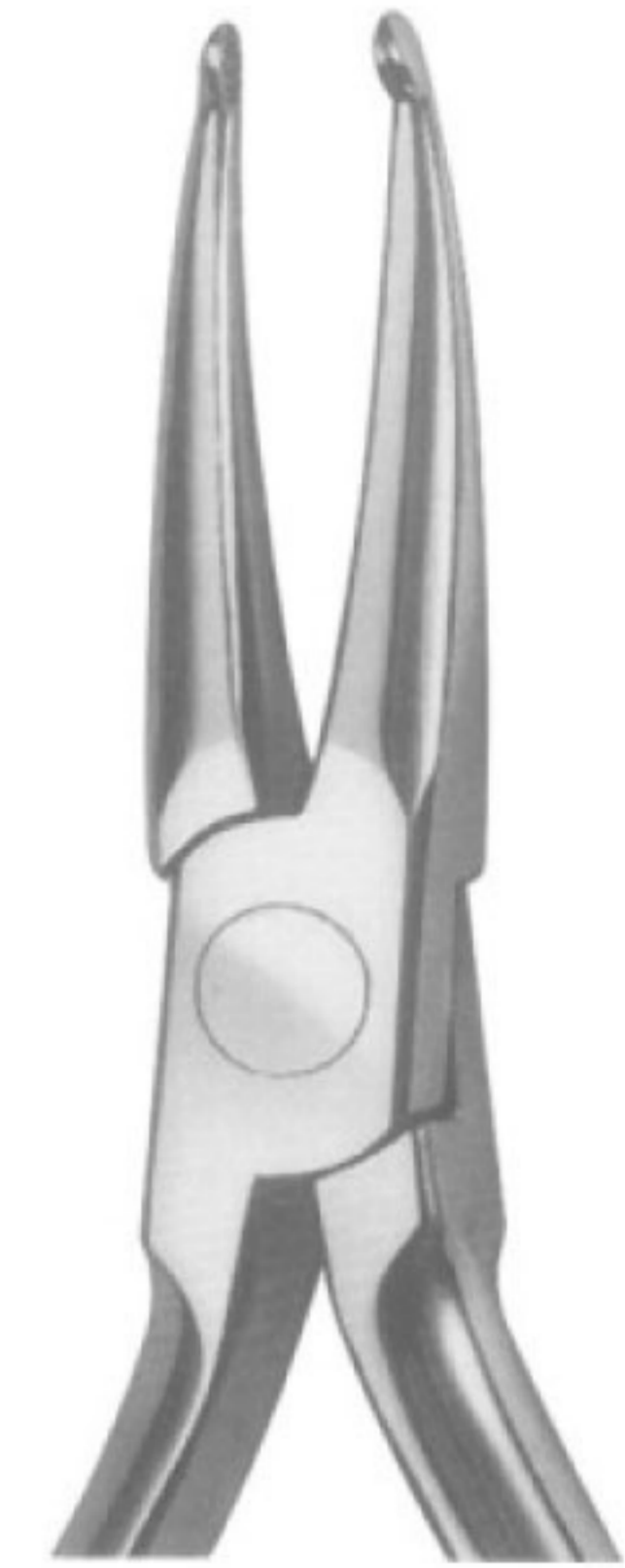

How Plier Tips are 1/8"(3.2mm) diameter
MWD-2458

How Plier Tips are 1/8"(3.2mm) diameter

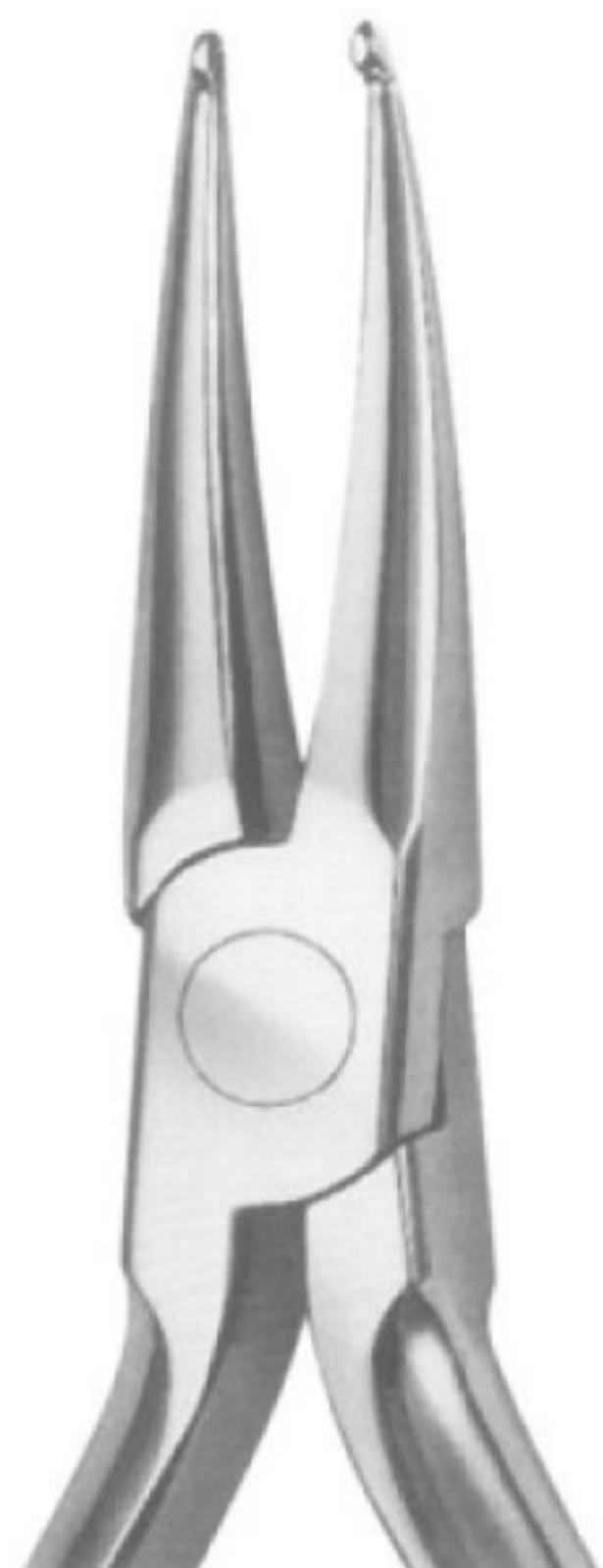

How Plier-Small Tips are 3/32"(2.4mm) diameter
MWD-2459

How Plier-Small Tips are 3/32"(2.4mm) diameter

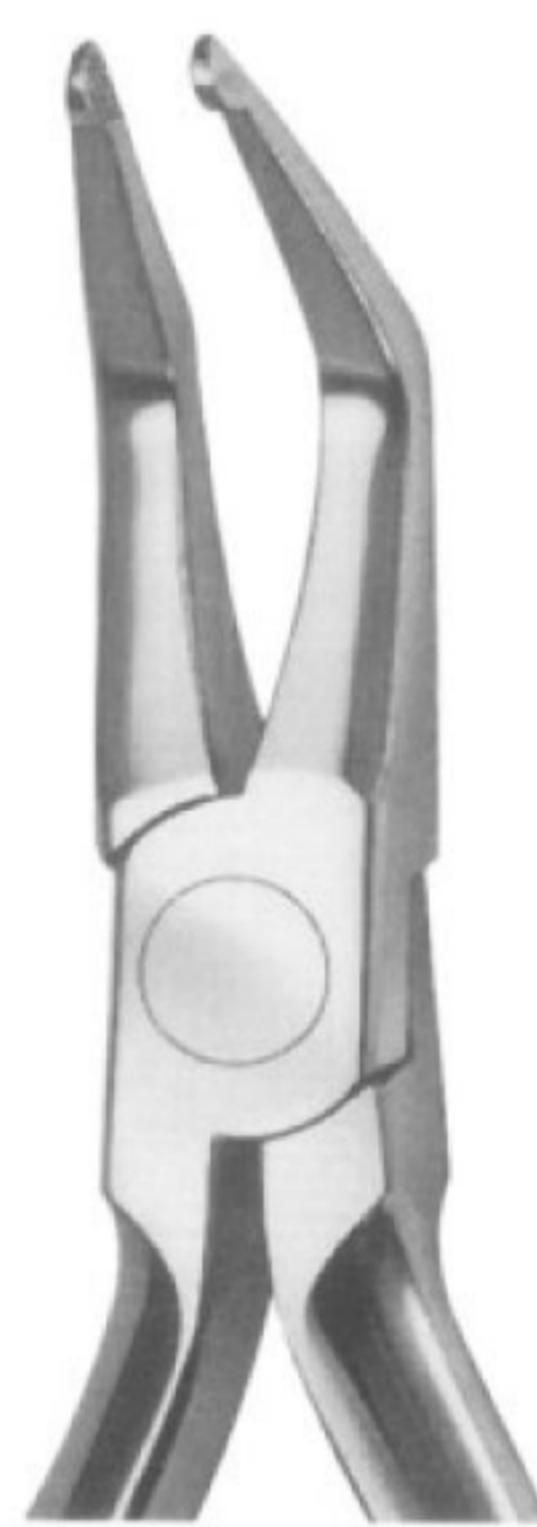

How Plier-Offset Tips are 1/8"(3.2mm) diameter
MWD-2460

How Plier-Offset Tips are 1/8"(3.2mm) diameter

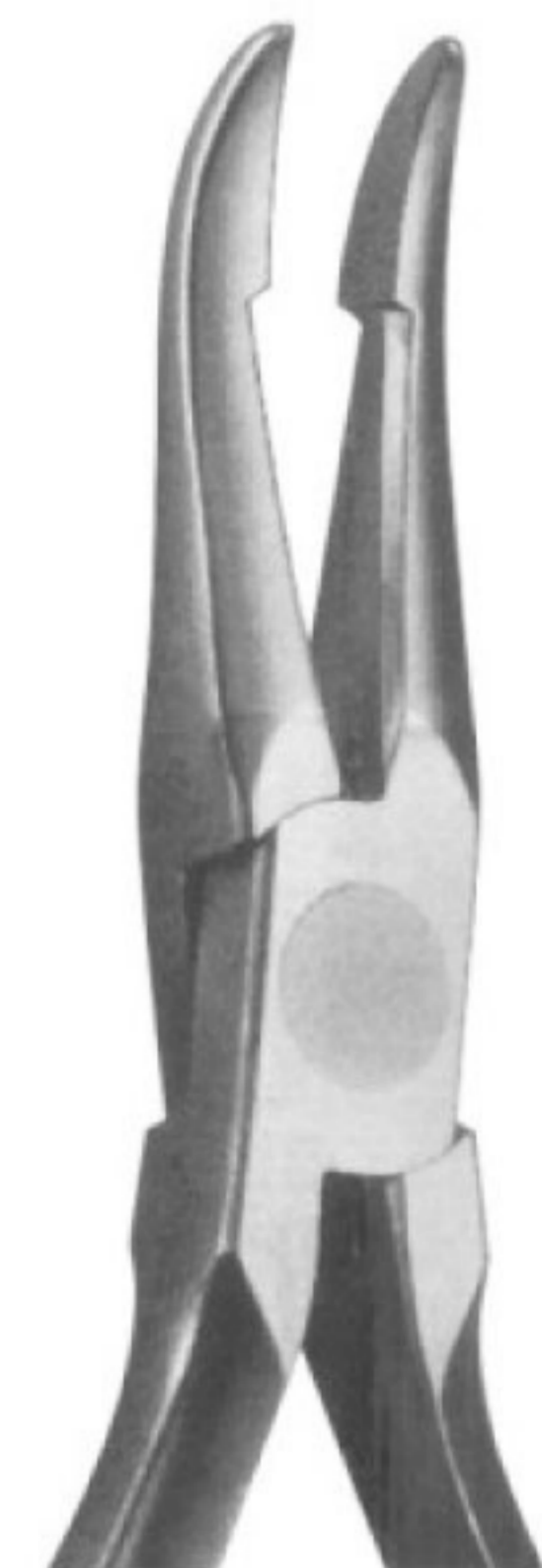

Weingart Utility Plier -Titanium Alloy with special coated beaks
MWD-2461

Weingart Utility Plier -Titanium Alloy with special coated beaks

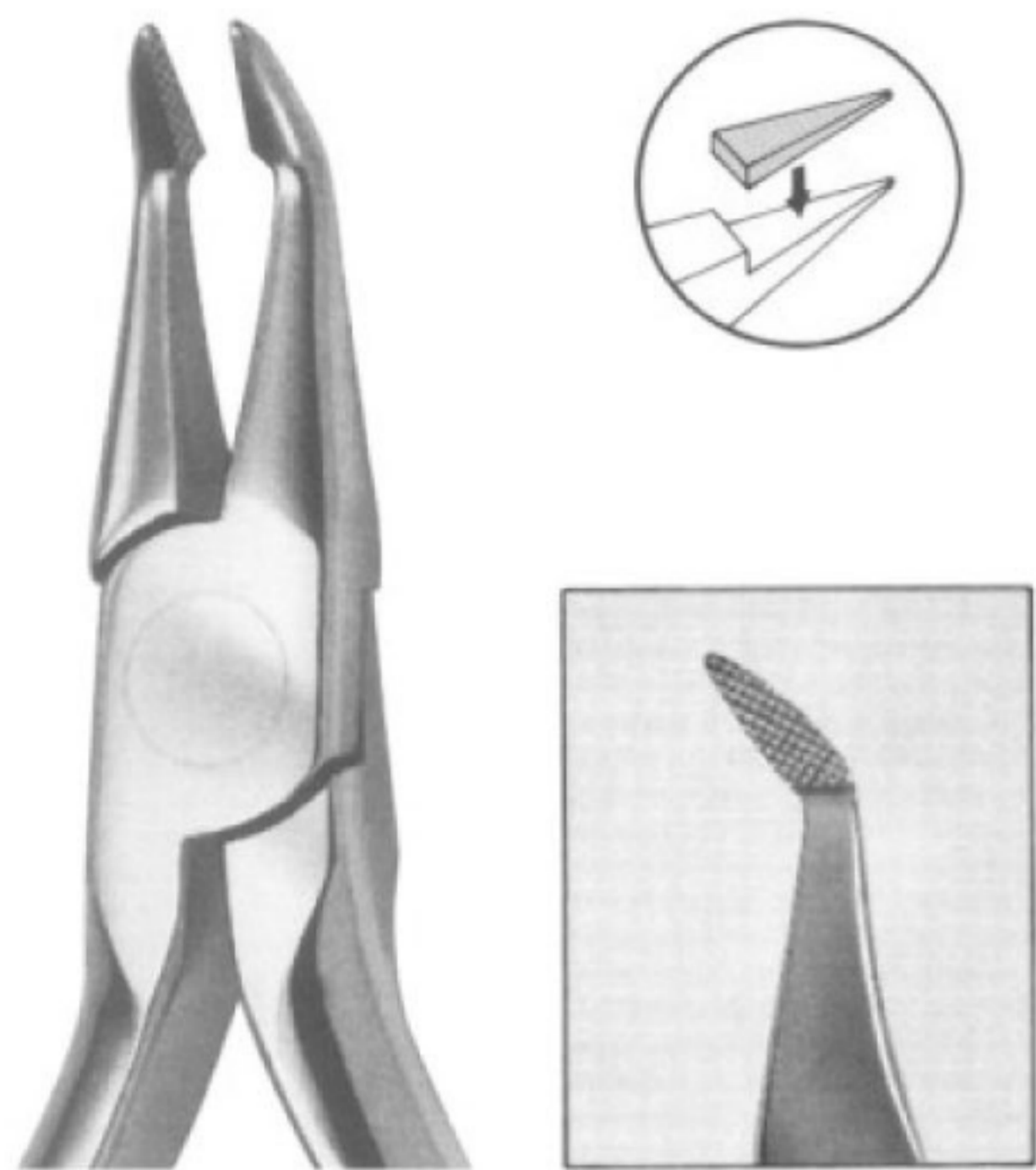

Weingart Utility Plier New type of the Weingart Utility Plier designed for a more precise operation.

MWD-2462

Weingart Utility Plier New type of the Weingart Utility Plier designed for a more precise operation.

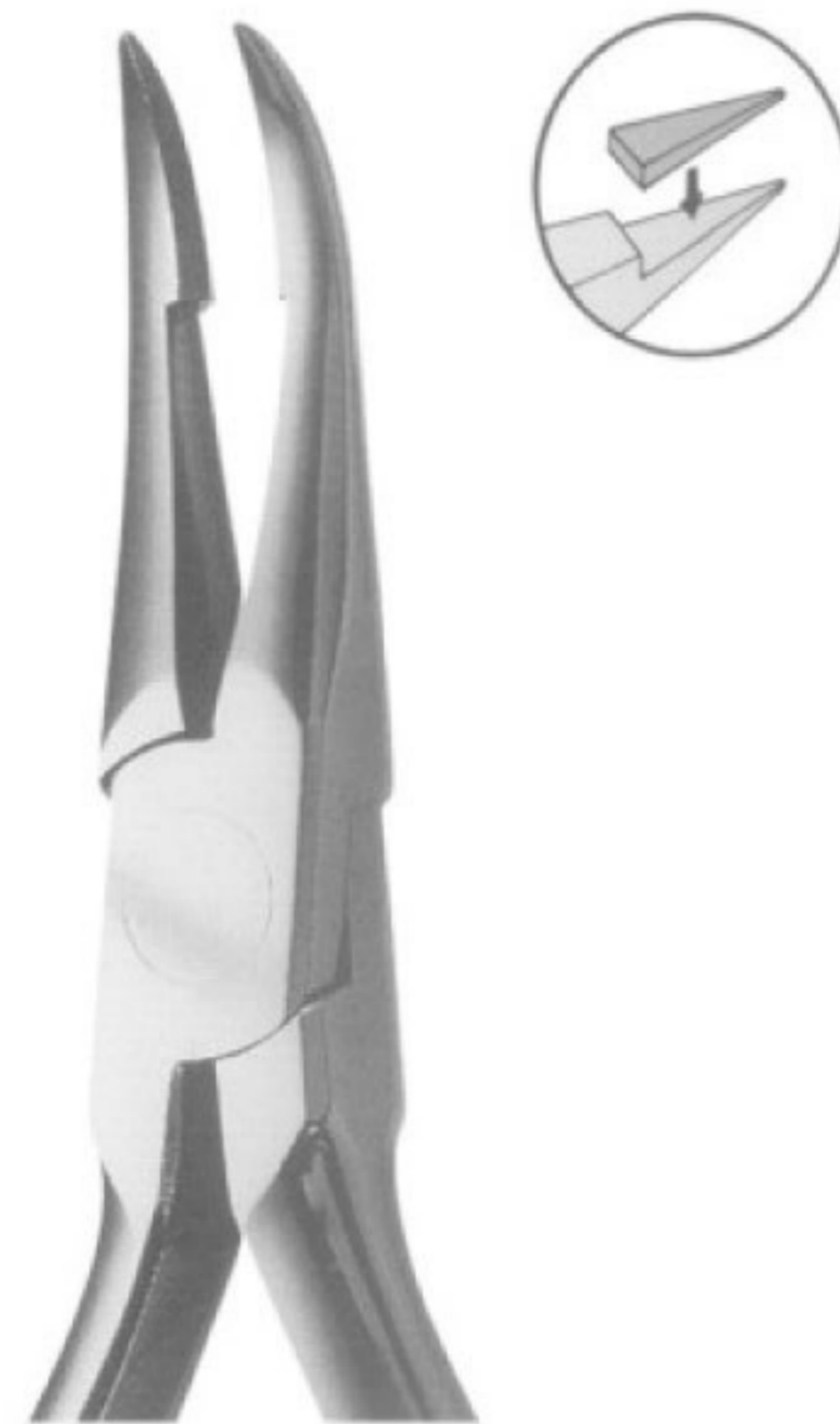

Weingart Utility Plier

MWD-2463

Weingart Utility Plier

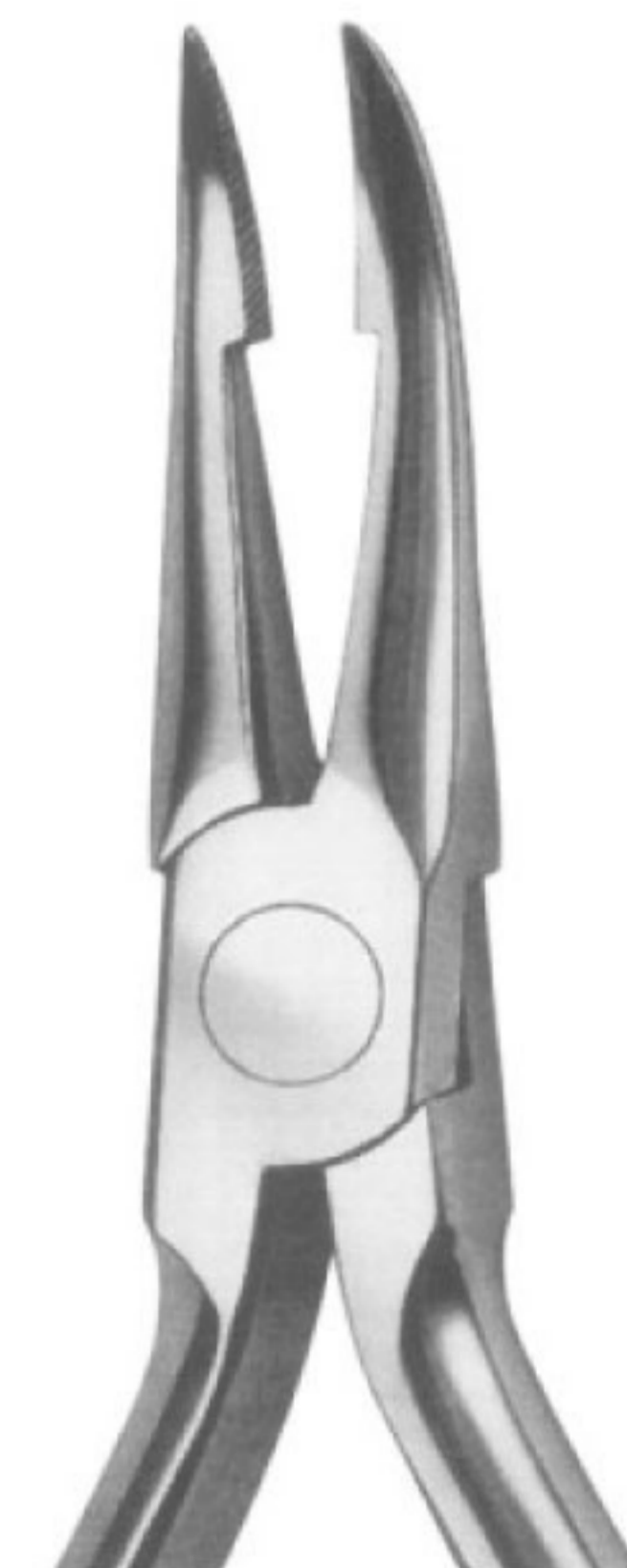

Weingart Utility Plier

MWD-2464

Weingart Utility Plier

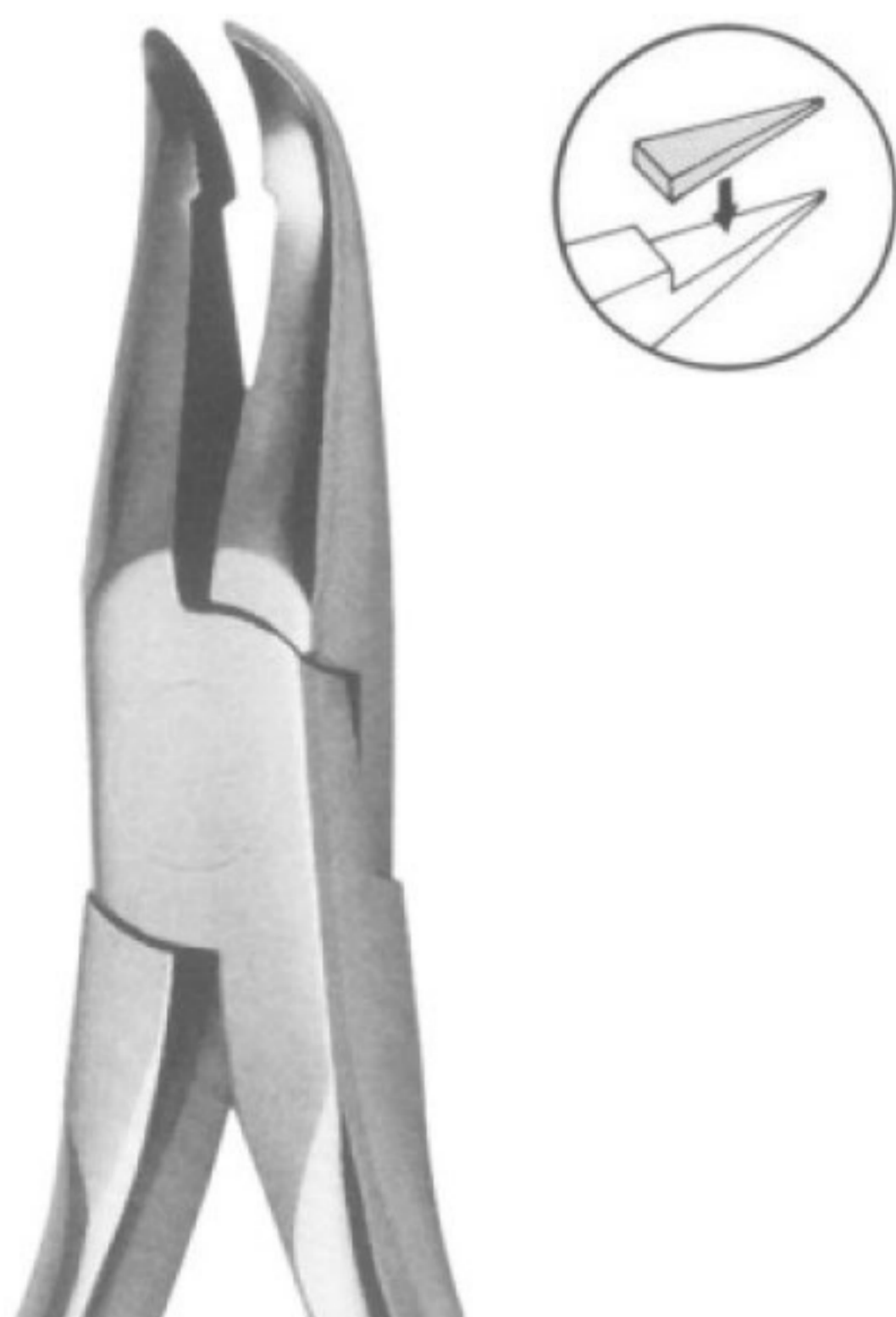

Weingart Utility Plier

MWD-2465

Weingart Utility Plier

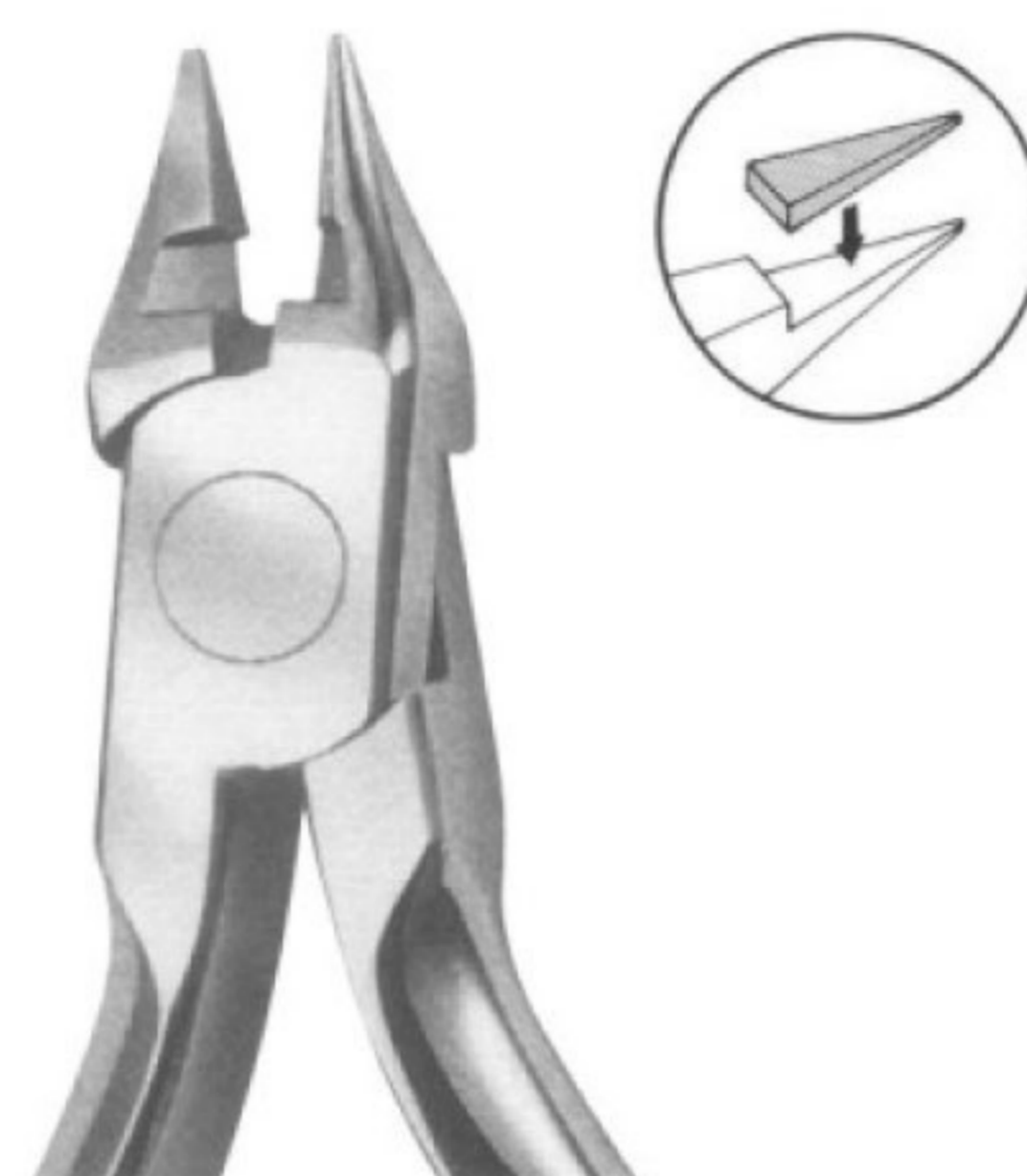

Bird Beak Plier With Cutter

MWD-2466

Bird Beak Plier With Cutter



Bird Beak Plier

MWD-2467

Bird Beak Plier

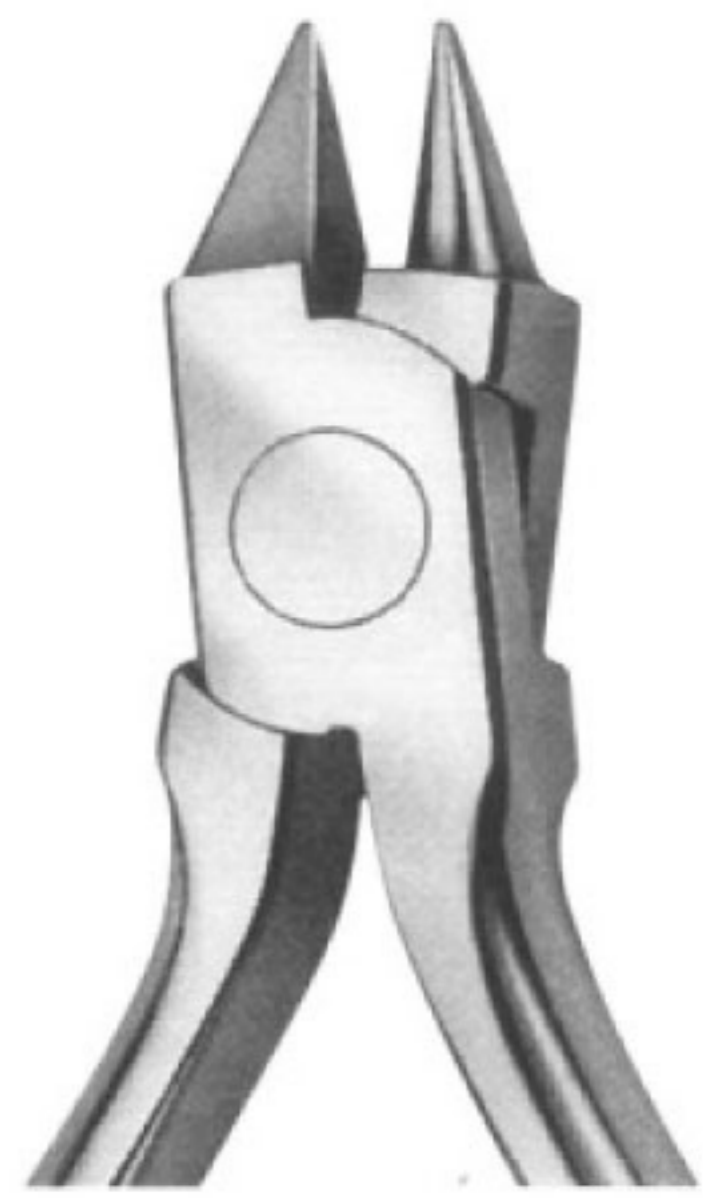

Bird Beak Plier
MWD-2468
 Bird Beak Plier

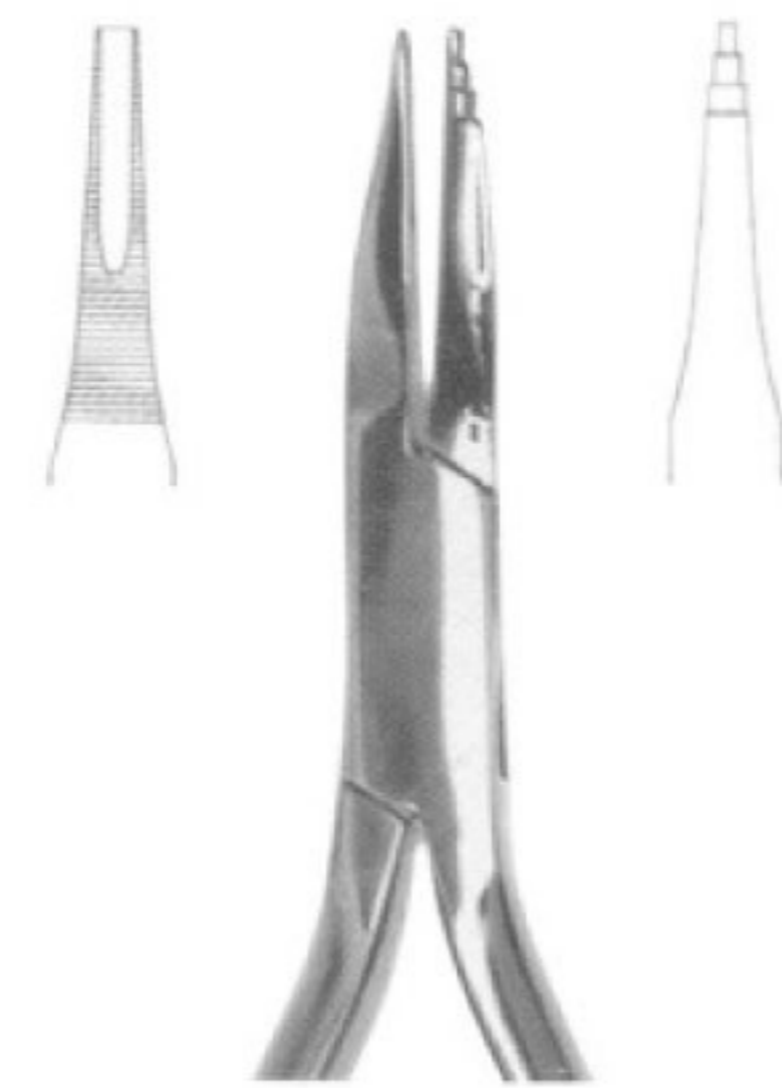

TWEED - (Fig. 90) 14 cm, 5 1/2"
MWD-2469
 TWEED - (Fig. 90) 14 cm, 5 1/2"

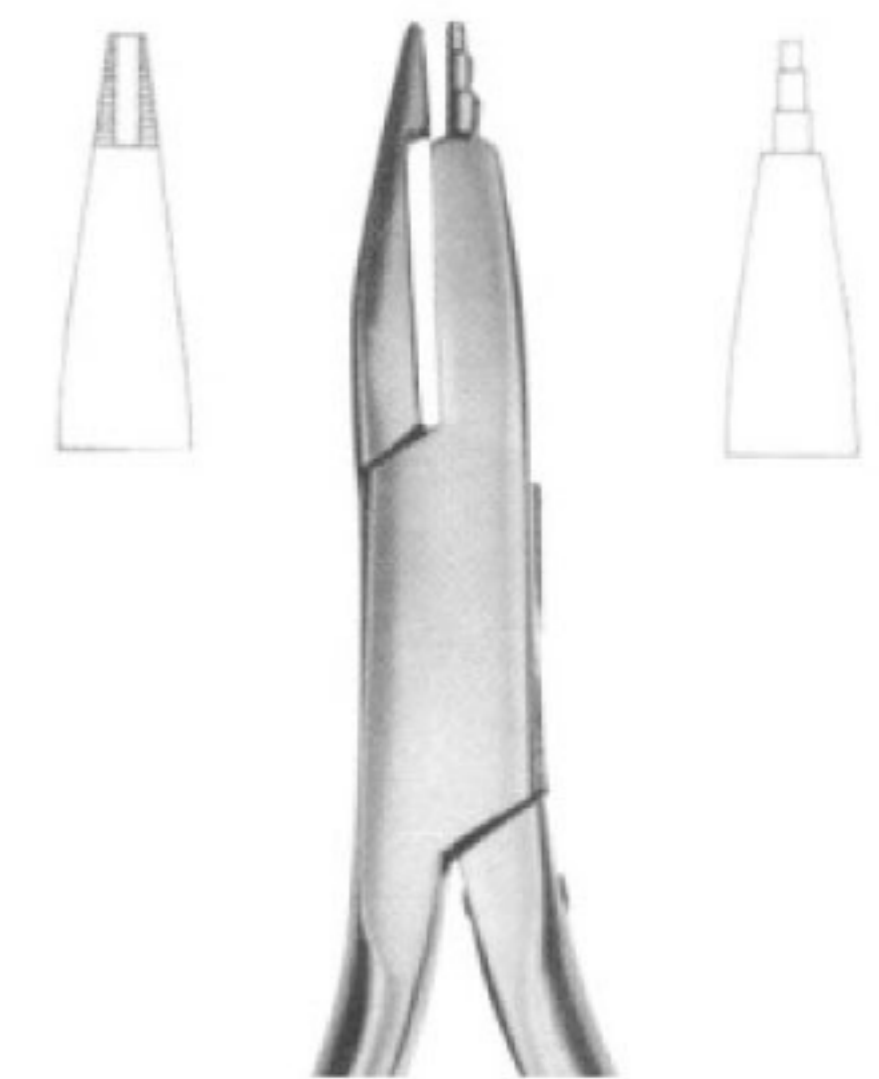

O'BRIEN - (Fig. 97) 14 cm, 5 1/2"
MWD-2470
 O'BRIEN - (14 cm, 5 1/2" Fig. 97)



TWEED (Fig. 98) 13 cm, 5 1/8" Tweed Loop Omega Pliers.
MWD-2471
 TWEED (Fig. 98) 13 cm, 5 1/8" Tweed Loop Omega Pliers.

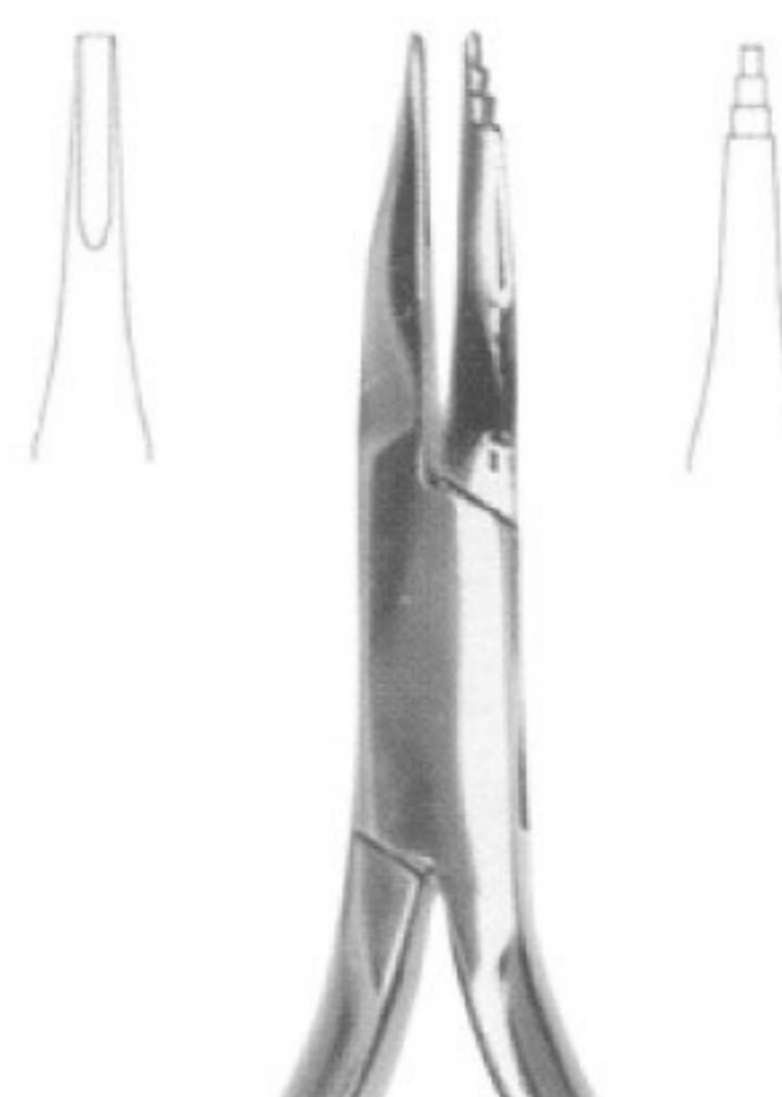

TWEED (Fig. 96) 14 cm, 5 1/2"
MWD-2472
 TWEED (Fig. 96) 14 cm, 5 1/2"

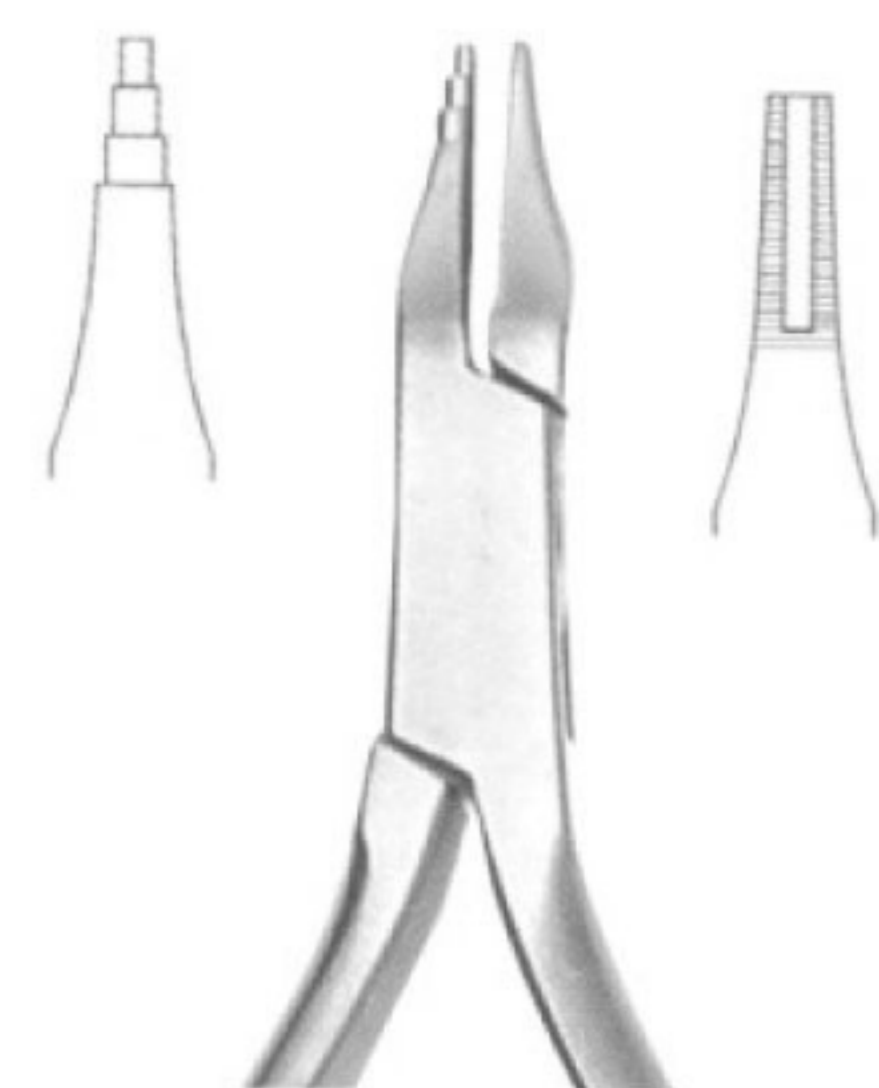

TWEED (Fig. 95) 13.5 cm, 5 1/4"
MWD-2473
 TWEED (Fig. 95) 13.5 cm, 5 1/4"

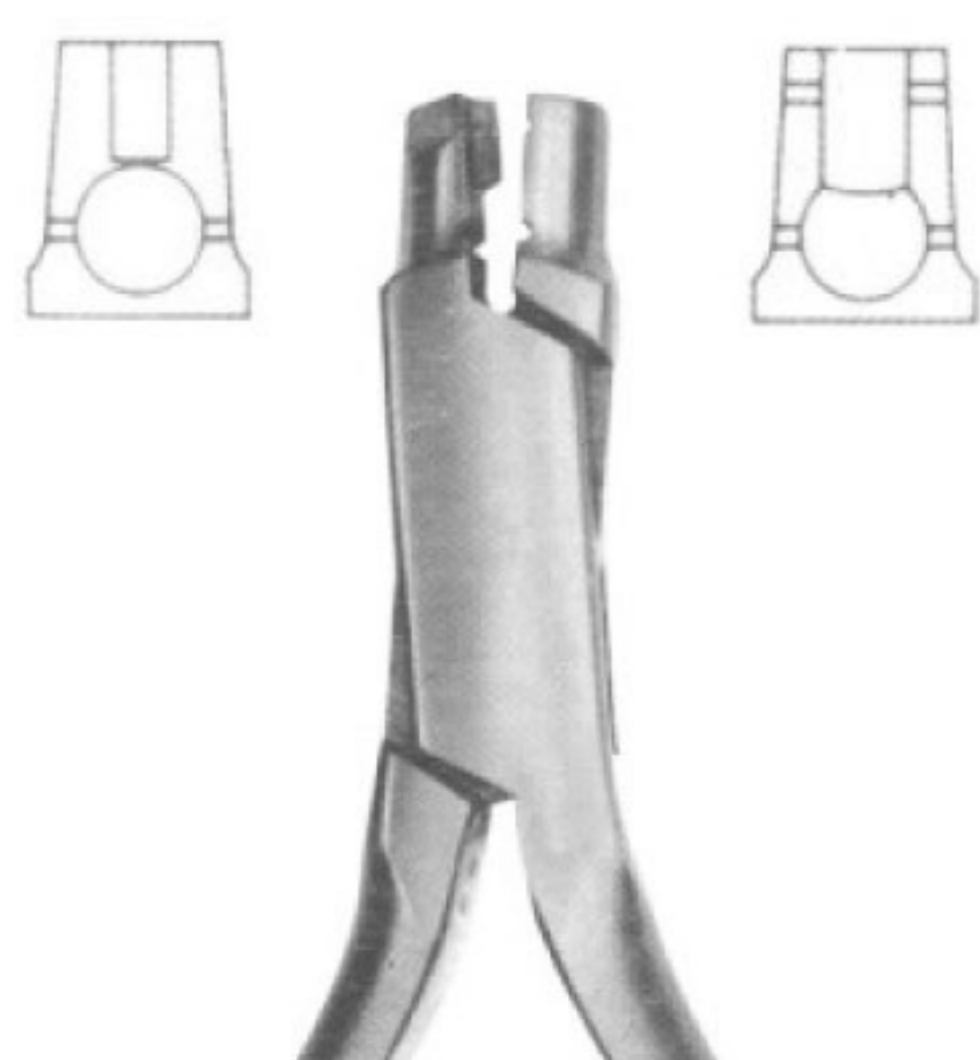

SCHWARZ (Fig. 29) 12.5 cm, 5"
MWD-2474
 SCHWARZ (Fig. 29) 12.5 cm, 5"

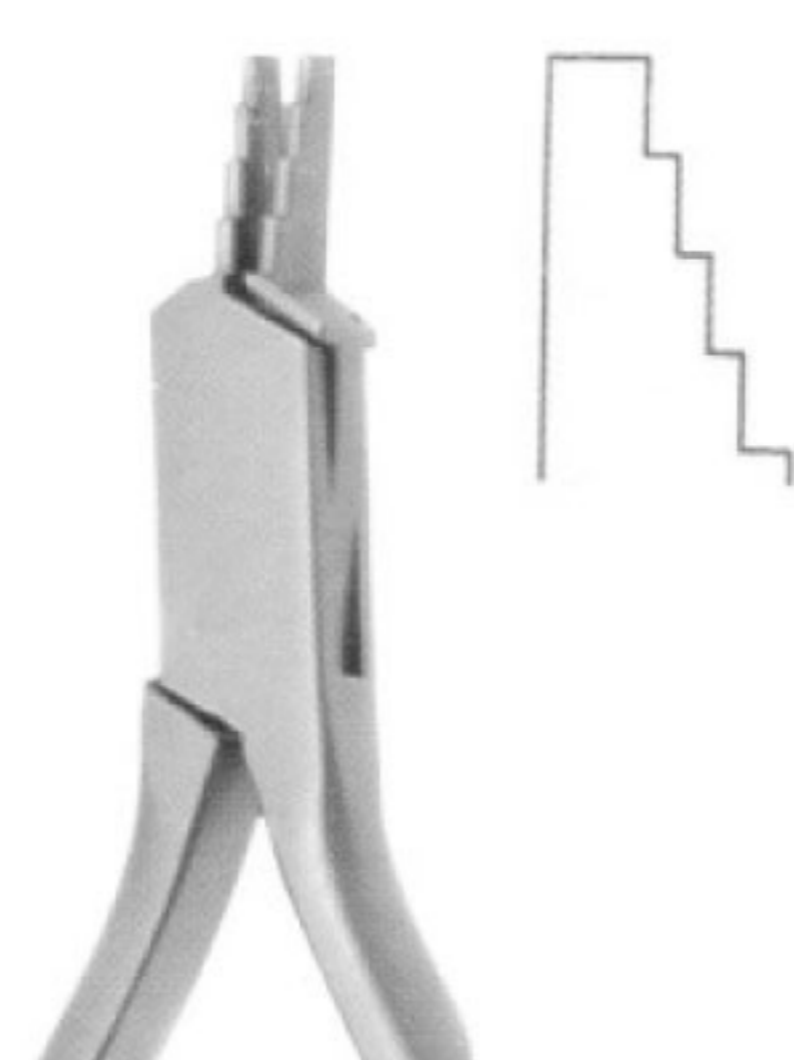

NANCE (Fig. 80) 13 cm, 5 1/8"
MWD-2475
 NANCE (Fig. 80) 13 cm, 5 1/8"

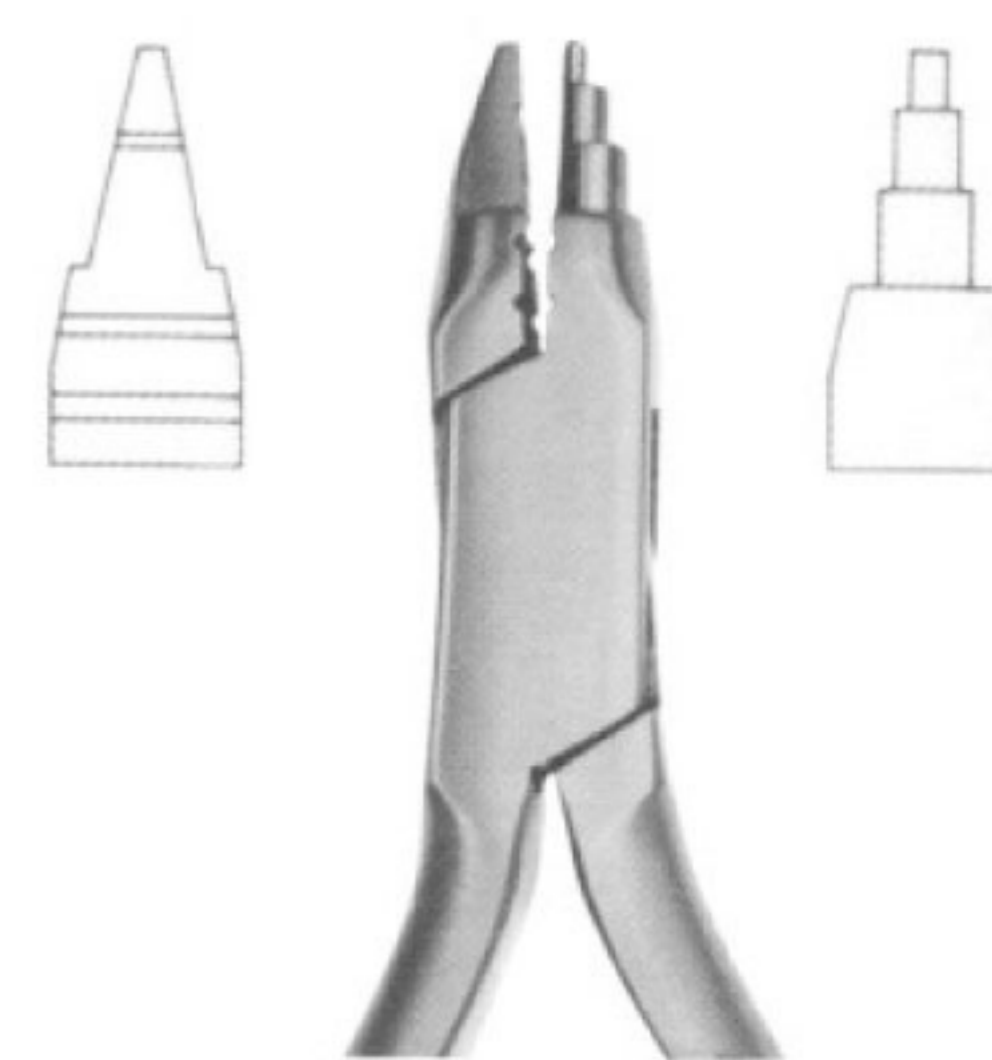

YOUNG (Fig. 55) 13 cm, 5 1/8"
MWD-2476
 YOUNG (Fig. 55) 13 cm, 5 1/8"

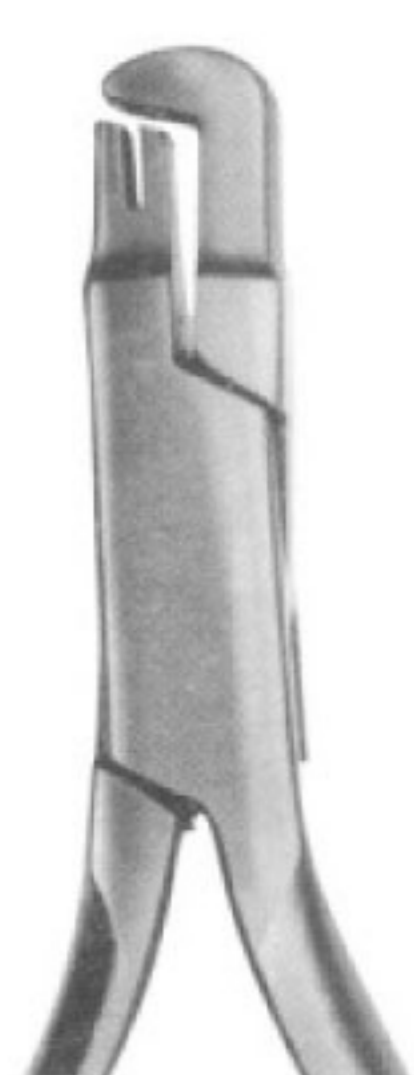

SCHWARZ (Fig. 30) 13 cm, 5 1/8"
MWD-2477
 SCHWARZ (Fig. 30) 13 cm, 5 1/8"

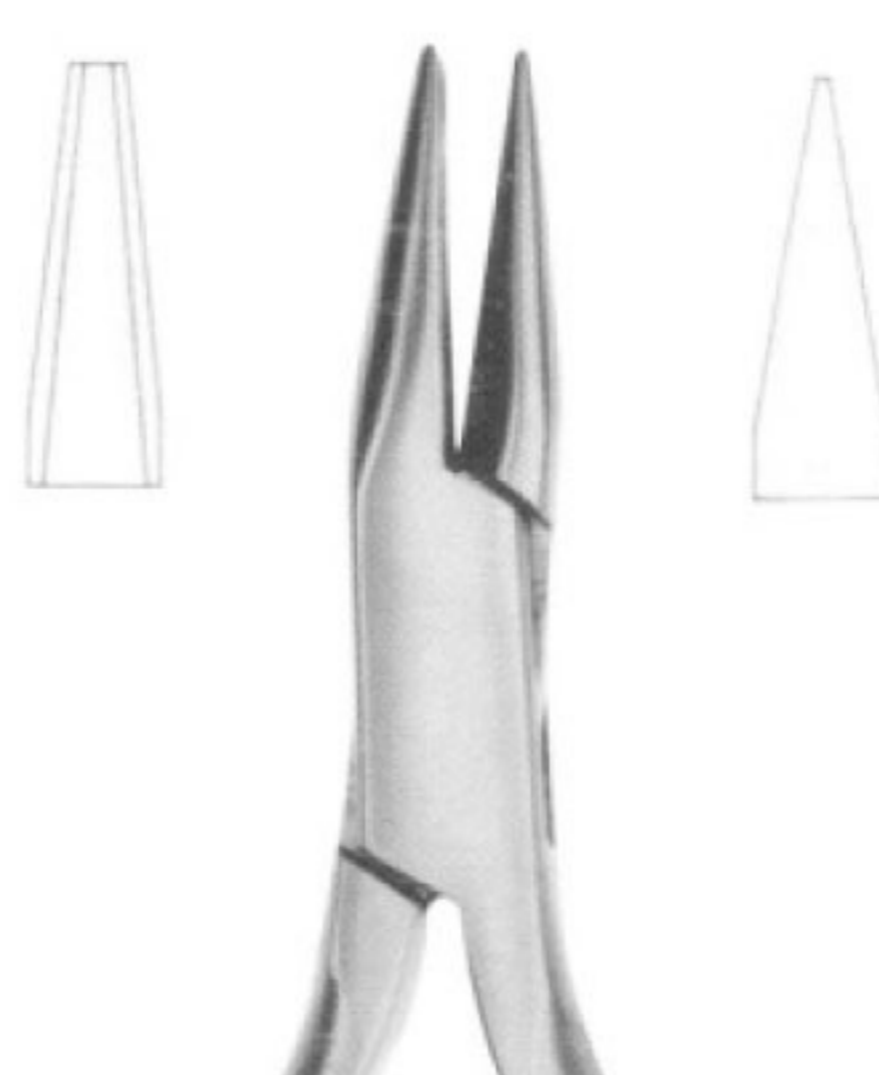

Optical Plier (Fig. 53) 14 cm, 5 1/2"
MWD-2478
 Optical Plier (Fig. 53) 14 cm, 5 1/2"

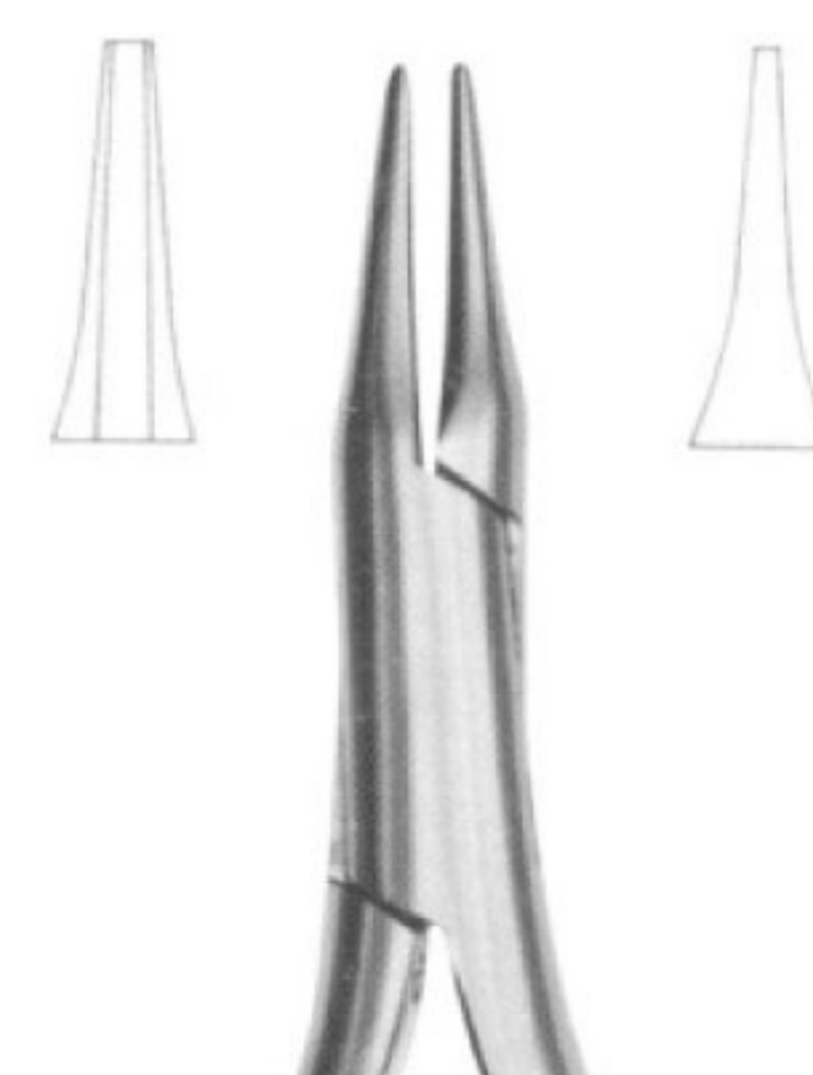

Schwarz (Fig. 79) 13.5 cm, 5 1/4"
MWD-2479
 Schwarz (Fig. 79) 13.5 cm, 5 1/4"



Fig. 60 13 cm, 5 1/8" Wire & Clasp Bending Pliers
MWD-2490

Fig. 60 13 cm, 5 1/8" Wire & Clasp Bending Pliers

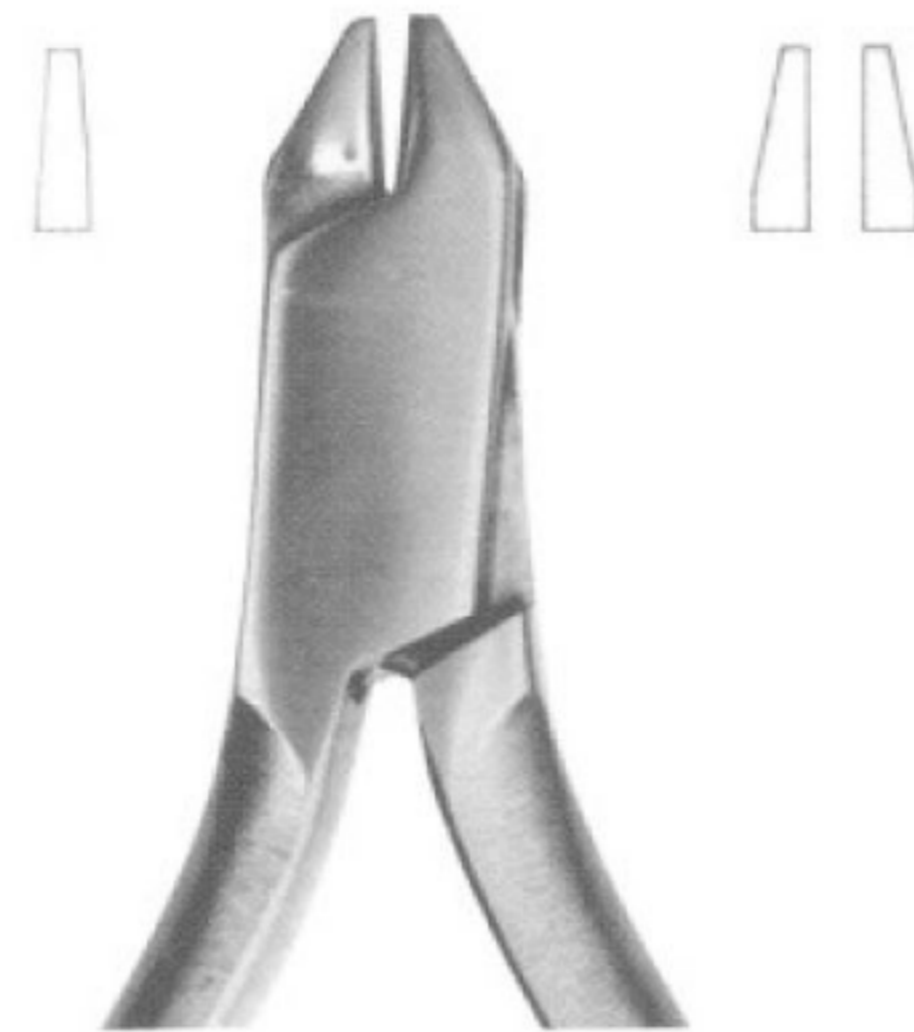
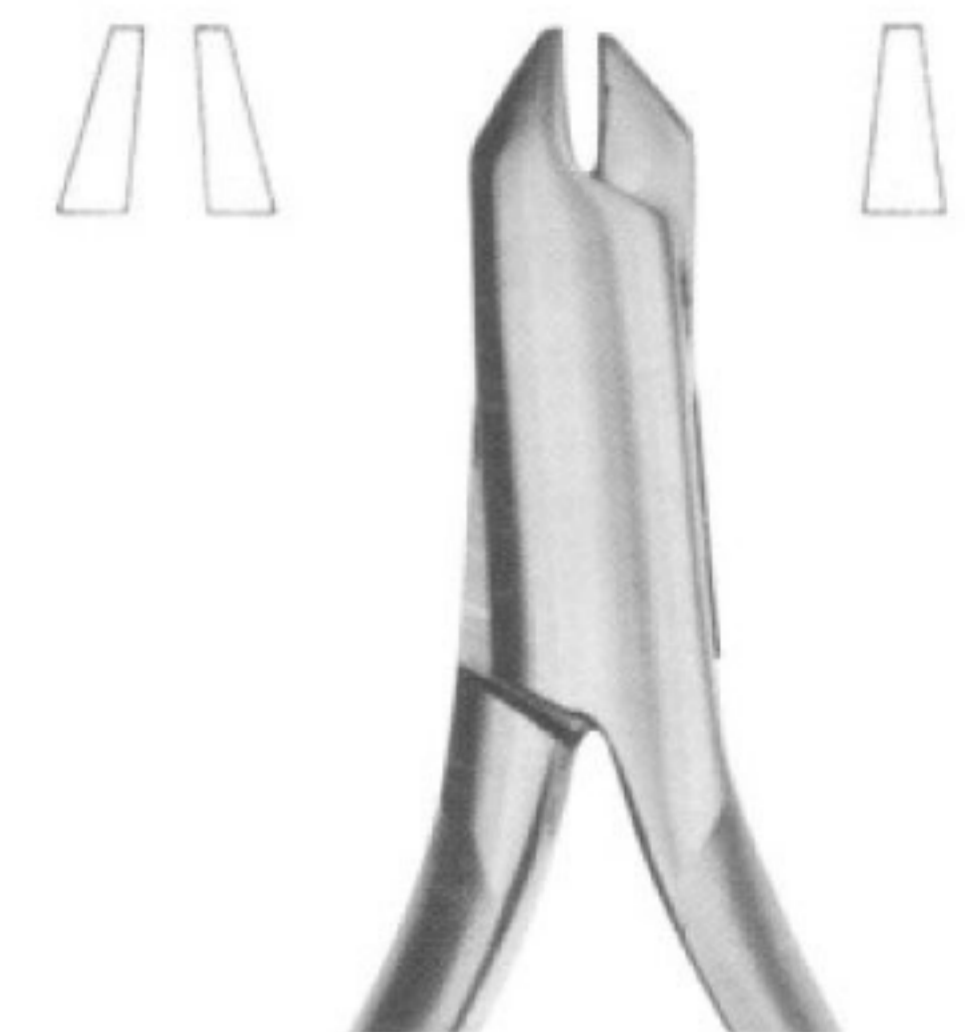

Fig. 60 13 cm, 5 1/8" Wire & Clasp Bending Pliers
MWD-2491

Fig. 60 13 cm, 5 1/8" Wire & Clasp Bending Pliers



Aderer (Fig. 57) 12 cm, 4 3/4" Wire & Clasp Bending Pliers
MWD-2492

Aderer (Fig. 57) 12 cm, 4 3/4" Wire & Clasp Bending Pliers



49 e 49 TC 14 cm, 5 1/2" Band Removing Plier, short pad
MWD-2493

49 e 49 TC 14 cm, 5 1/2" Band Removing Plier, short pad

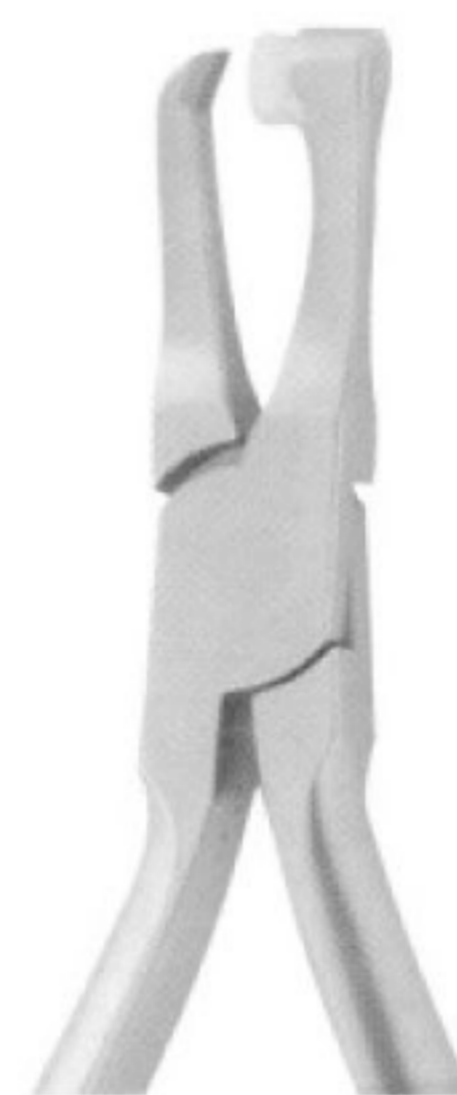

50 e 50 TC 14 cm, 5 1/2" Band Removing Plier, long pad
MWD-2494

50 e 50 TC 14 cm, 5 1/2" Band Removing Plier, long pad



Fig. 84 14.5 cm, 5 3/4" Band pinshing & ligature locking plier, serrated
MWD-2495

Fig. 84 14.5 cm, 5 3/4" Band pinshing & ligature locking plier, serrated

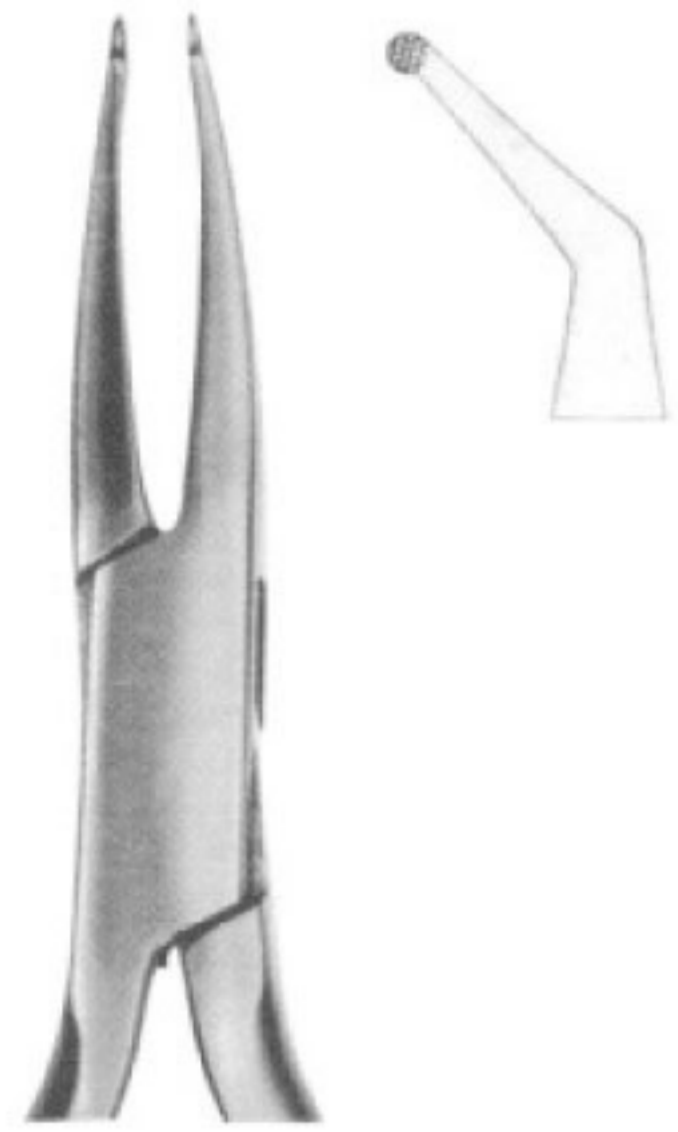

**Fig. 72 14 cm, 5 1/2" Band pinshing & ligature locking plier, serrated
MWD-2496**

Fig. 72 14 cm, 5 1/2" Band pinshing & ligature locking plier, serrated



**BRACKET (Fig. 82) 13.5 cm, 5 1/4" Direct Bonding Bracket Remover
MWD-2497**

BRACKET (Fig. 82) 13.5 cm, 5 1/4" Direct Bonding Bracket



**BRACKET (Fig. 83) 13.5 cm, 5 1/4" Direct Bonding Bracket Remover
MWD-2498**

BRACKET (Fig. 83) 13.5 cm, 5 1/4" Direct Bonding Bracket Remover



**38c, 38TC 13.5 cm, 5 1/4" Contouring closing loop pliers, wire bending, cutter.
MWD-2499**

38c, 38TC 13.5 cm, 5 1/4" Contouring closing loop pliers, wire bending, cutter.

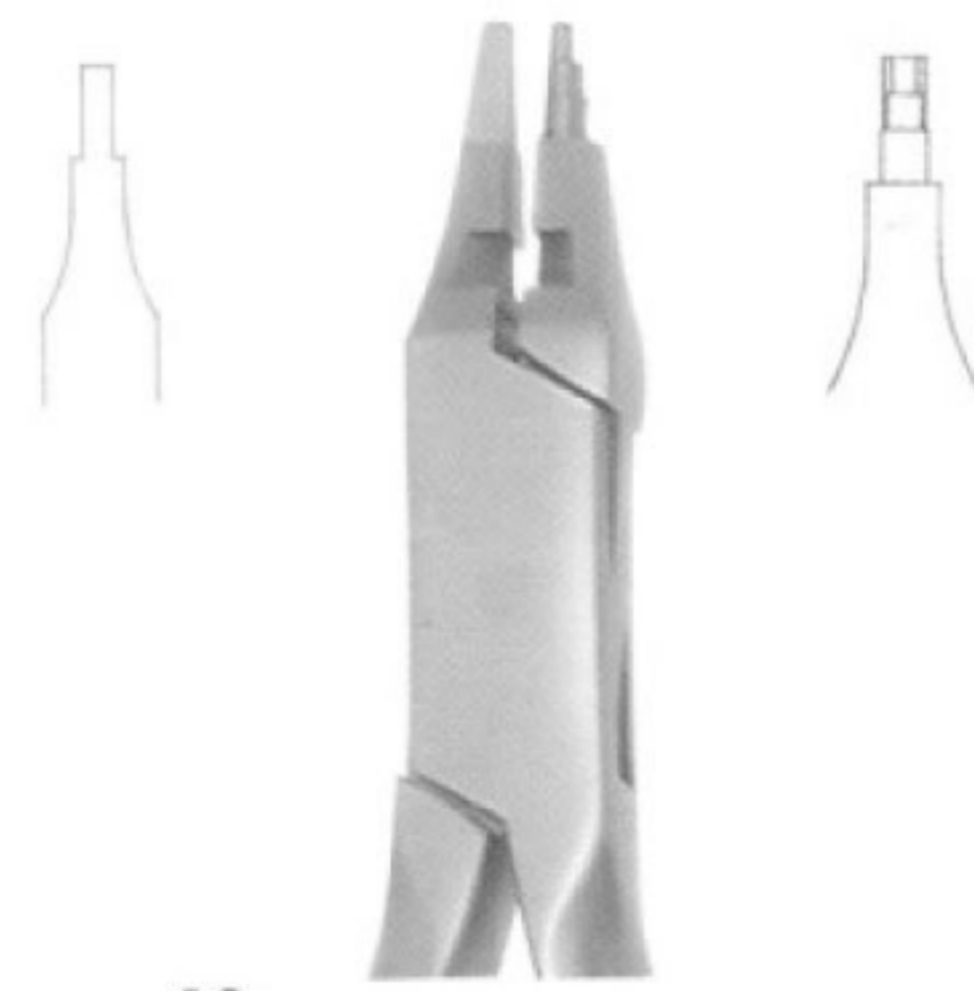

**40c, 40TC 13.5 cm, 5 1/4" Contouring pliers light wire pliers grooved with cutter.
MWD-2500**

40c, 40TC 13.5 cm, 5 1/4" Contouring pliers light wire

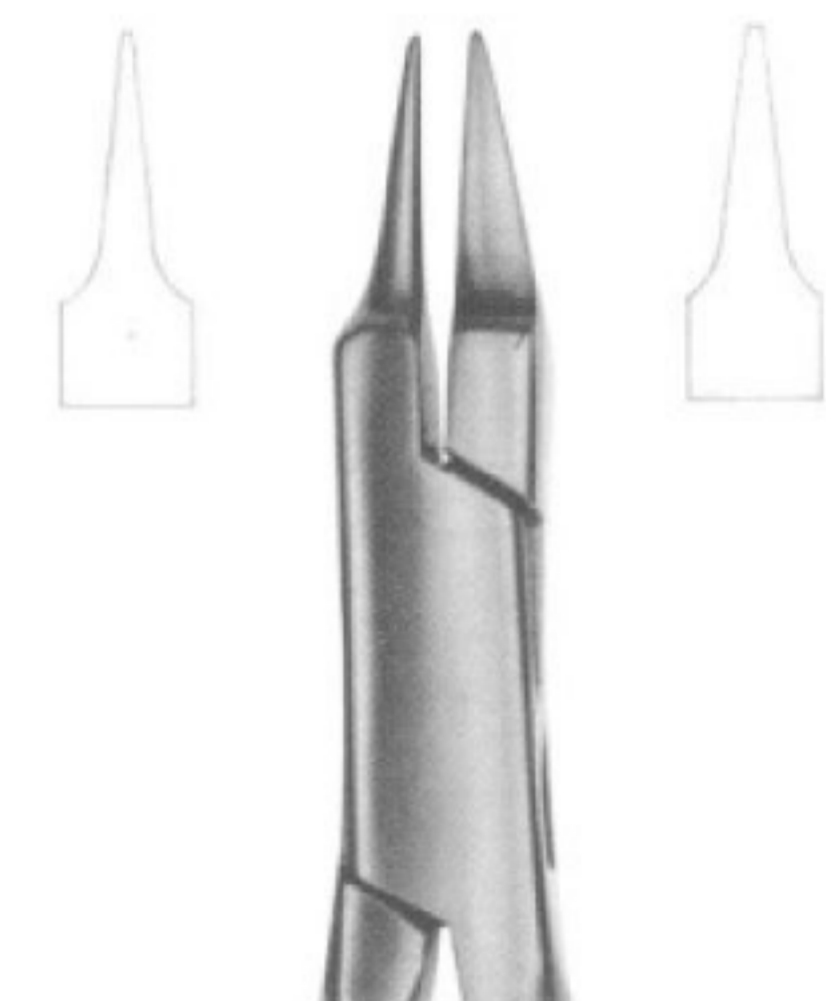

**Fig. 81 12.5 cm, 5" Sling clasp & wire bending plier
MWD-2501**

Fig. 81 12.5 cm, 5" Sling clasp & wire bending plier

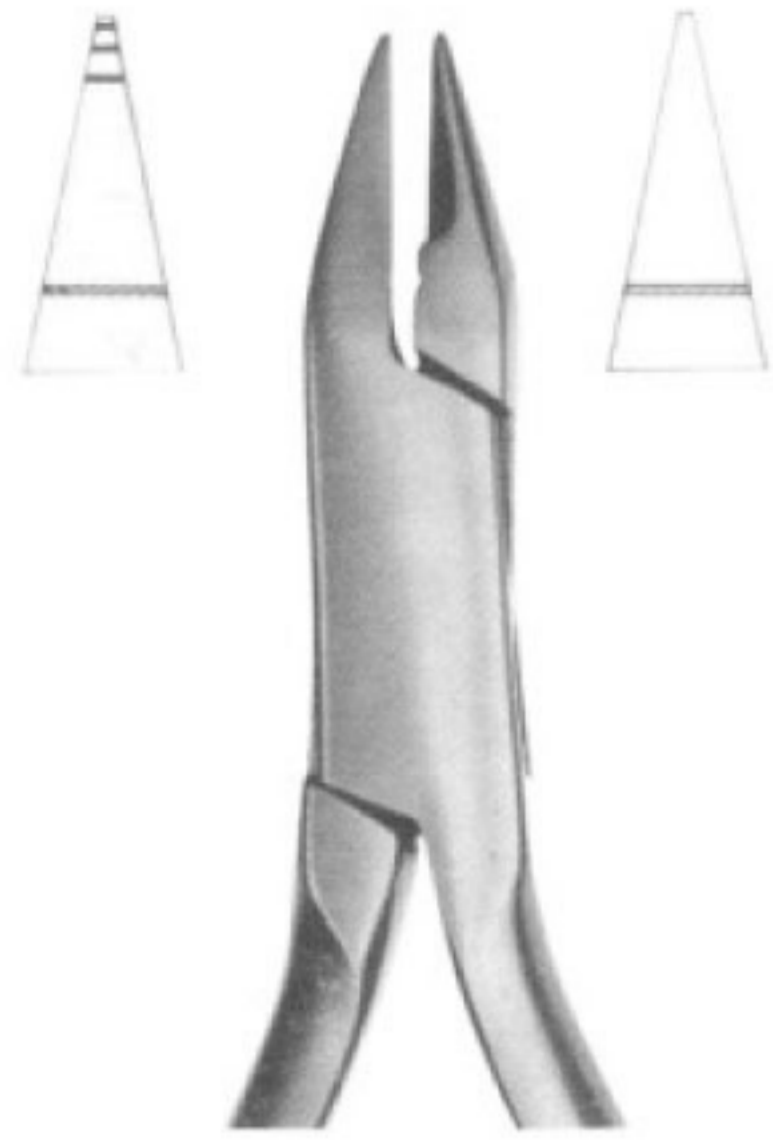

**Fig. 21 13 cm, 5 1/8" Light wires pliers, grooved
MWD-2503**

Fig. 21 13 cm, 5 1/8" Light wires pliers, grooved



**46c - 46 TC ADAMS - N. 139c 12.5 cm, 5" Bird beak with cutter.
MWD-2504**

46c - 46 TC ADAMS - N. 139c 12.5 cm, 5" Bird beak with

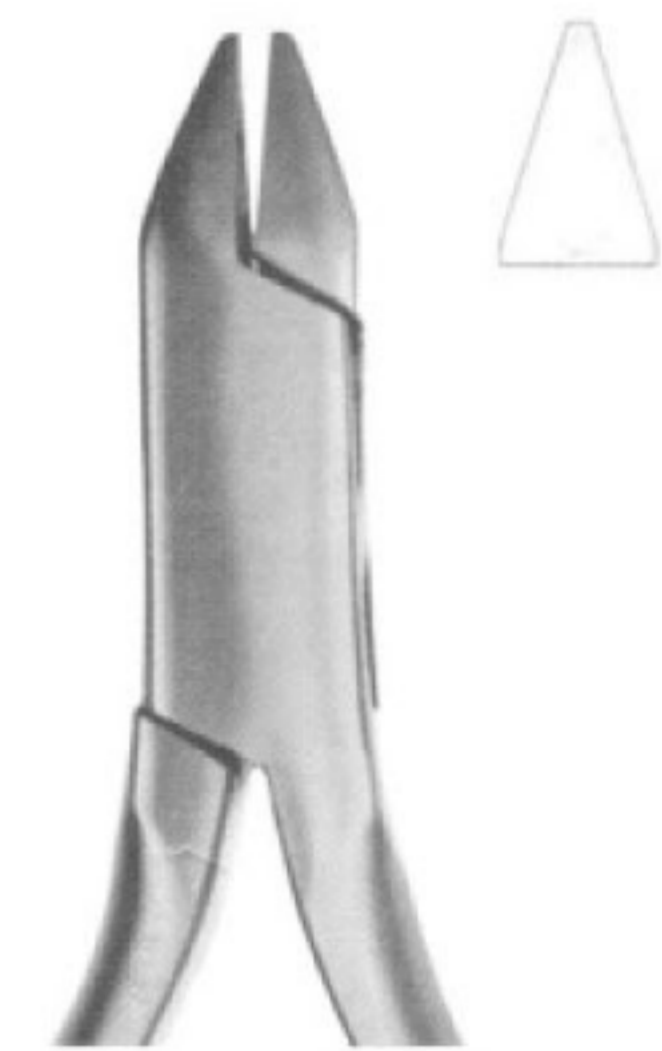

**ADAMS, 23, 23TC 12.5 cm, 5" Sling clasp & wire bending plier.
MWD-2505**

ADAMS, 23, 23TC 12.5 cm, 5" Sling clasp & wire bending plier.

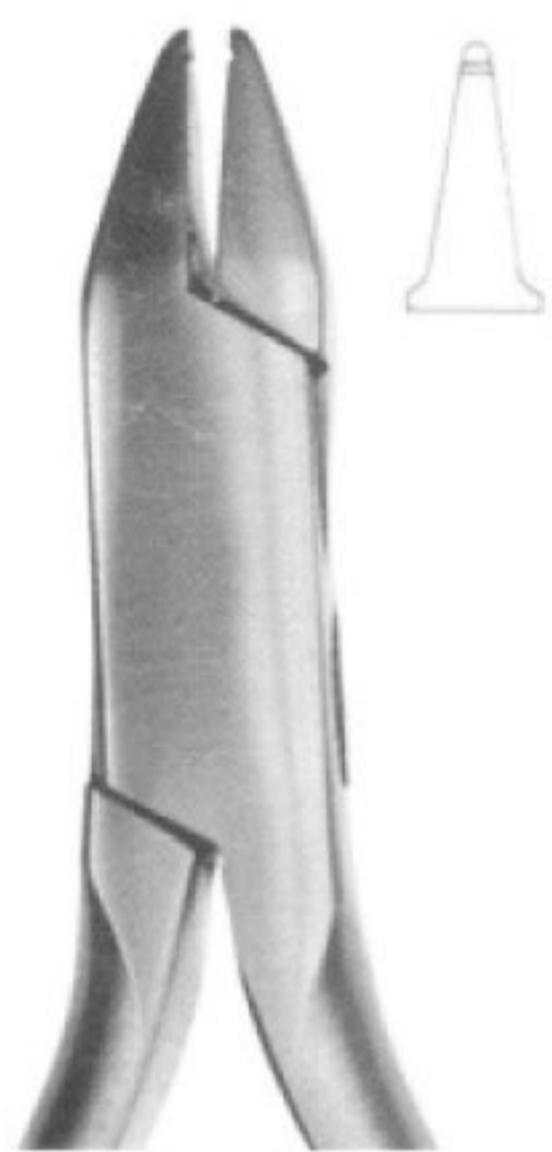

**ADAMS (Fig. 33) 12.5 cm, 5" For retaining elements.
MWD-2506**

ADAMS (Fig. 33) 12.5 cm, 5" For retaining elements.

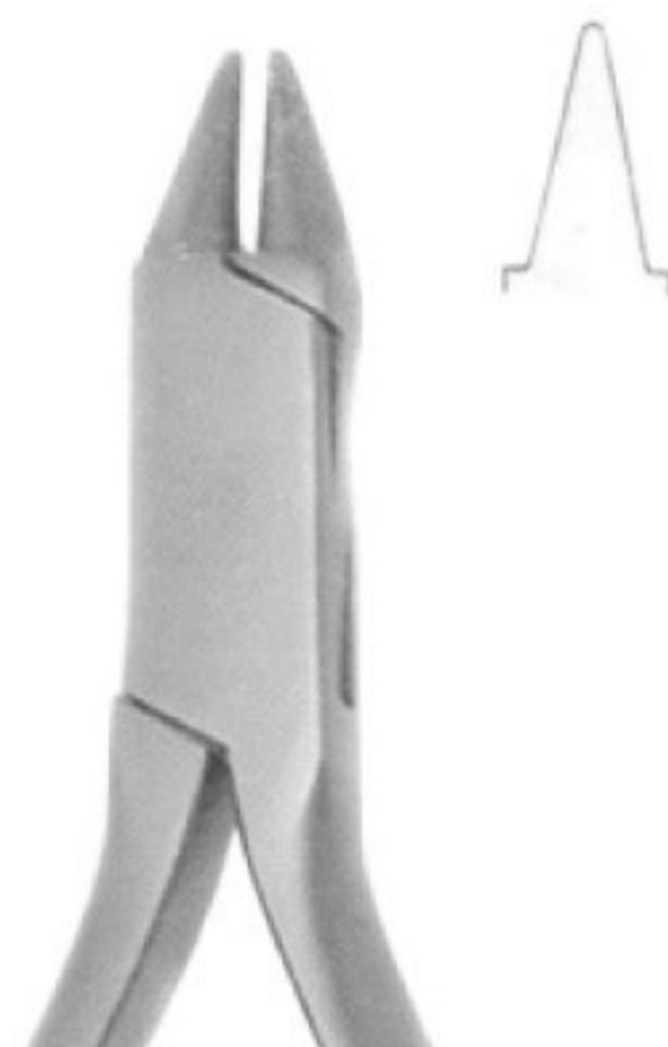

**ADAMS (Fig. 44) 12.5 cm, 5" Sling clasp & wire bending plier.
MWD-2507**

ADAMS (Fig. 44) 12.5 cm, 5" Sling clasp & wire bending plier.



**86c, 86 TC Angle Bird Beak - N.138 12.5 cm, 5" Sling clasp & wire bending plier.
MWD-2509**

86c, 86 TC Angle Bird Beak - N.138 12.5 cm, 5" Sling clasp & wire bending plier.



Fig. 18 TC 15 cm, 6"
MWD-2510
Fig. 18 TC 15 cm, 6"

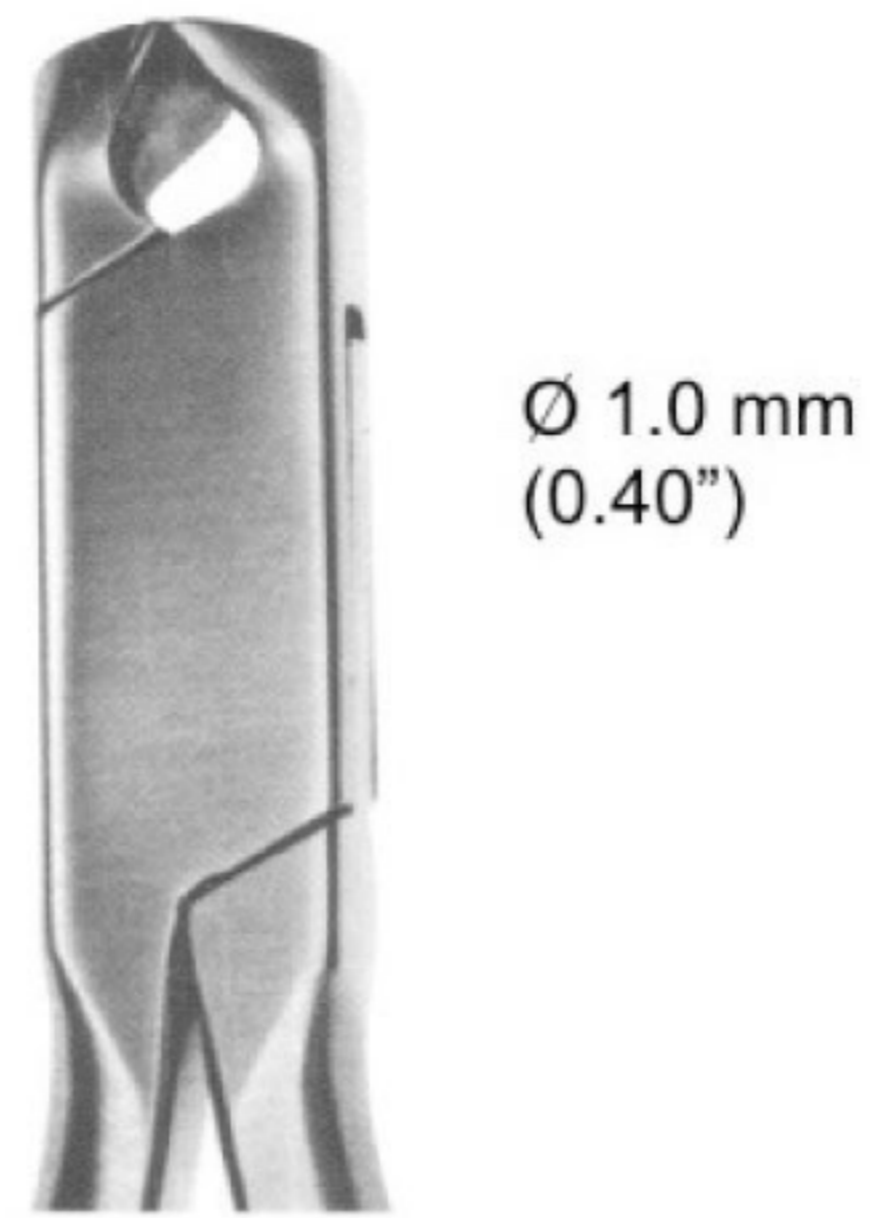

Fig. 92 TC 14 cm, 5 1/2"
MWD-2511
Fig. 92 TC 14 cm, 5 1/2"

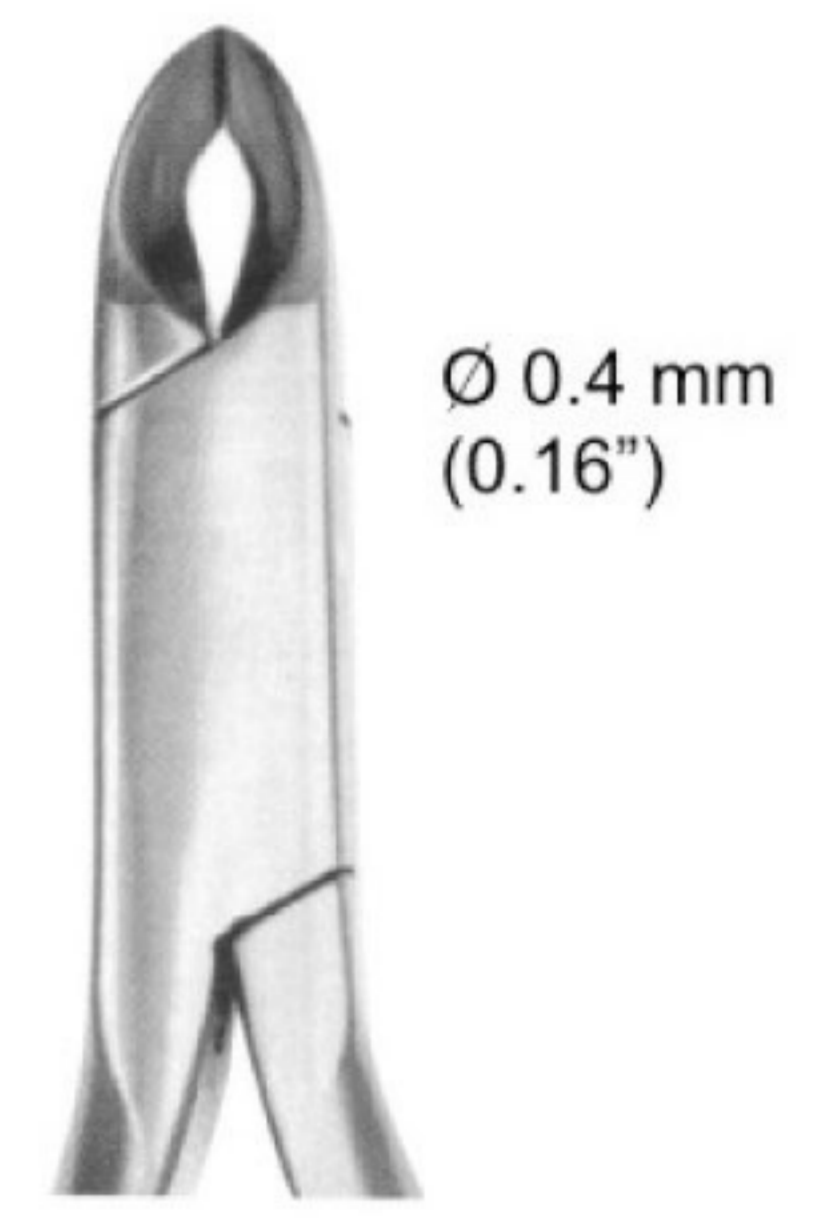

Fig. 91 TC 13 cm, 5 1/8"
MWD-2512
Fig. 91 TC 13 cm, 5 1/8"

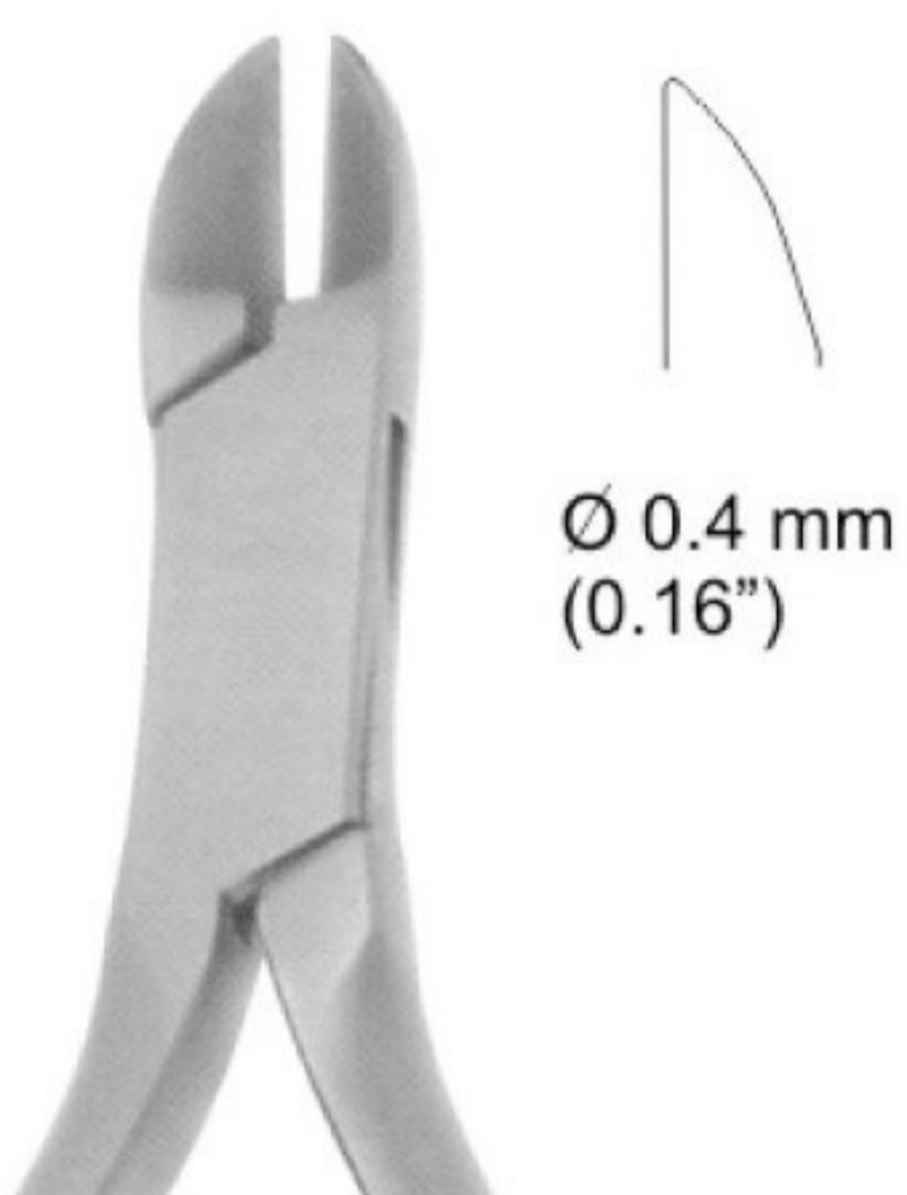

Fig. 99 TC 13 cm, 5 1/8"
MWD-2513
Fig. 99 TC 13 cm, 5 1/8"

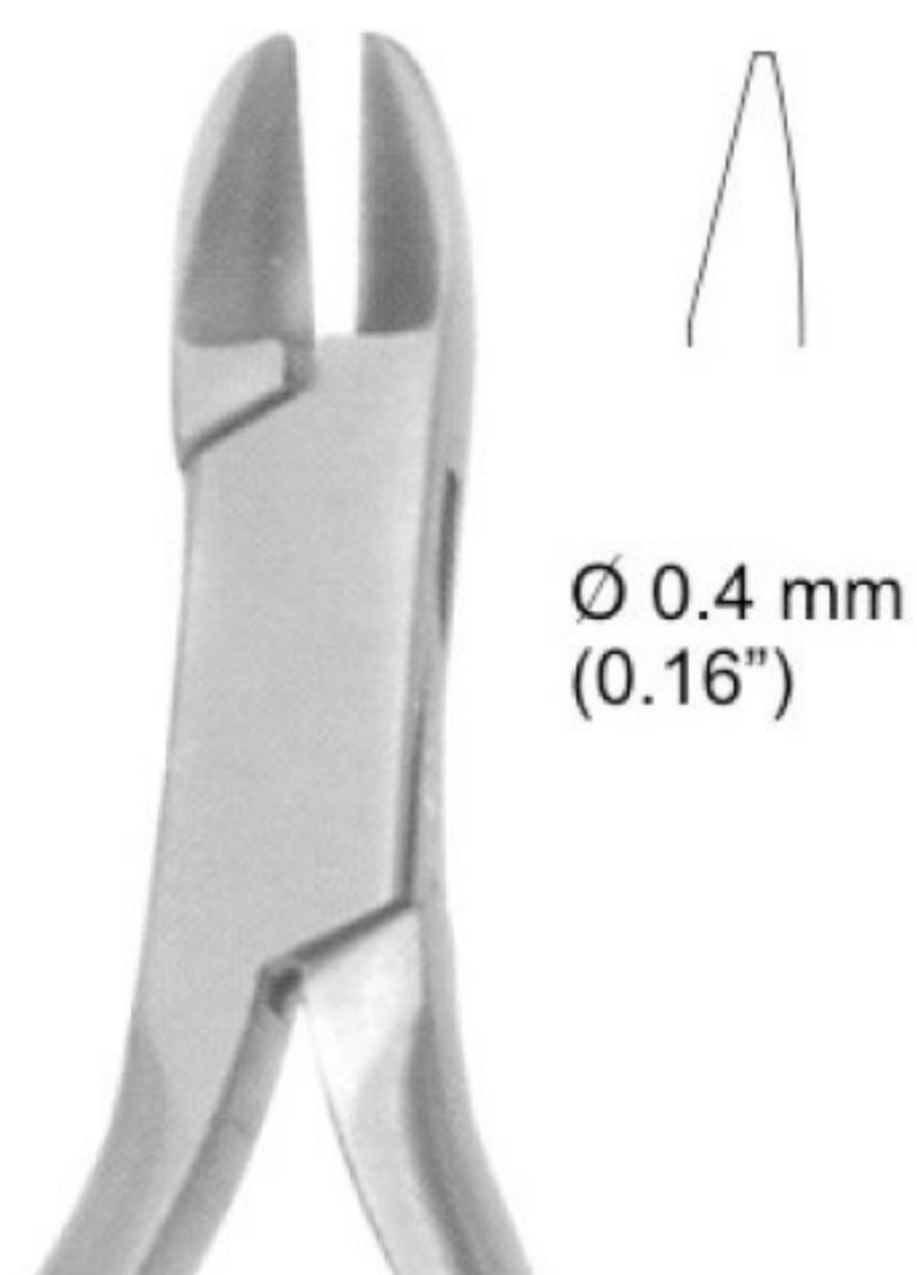

Fig. 94 TC 13 cm, 5 1/8" Angled at 15 with or without spring on \ the handles.
MWD-2514
Fig. 94 TC 13 cm, 5 1/8" Angled at 15 with or without spring on \ the handles.

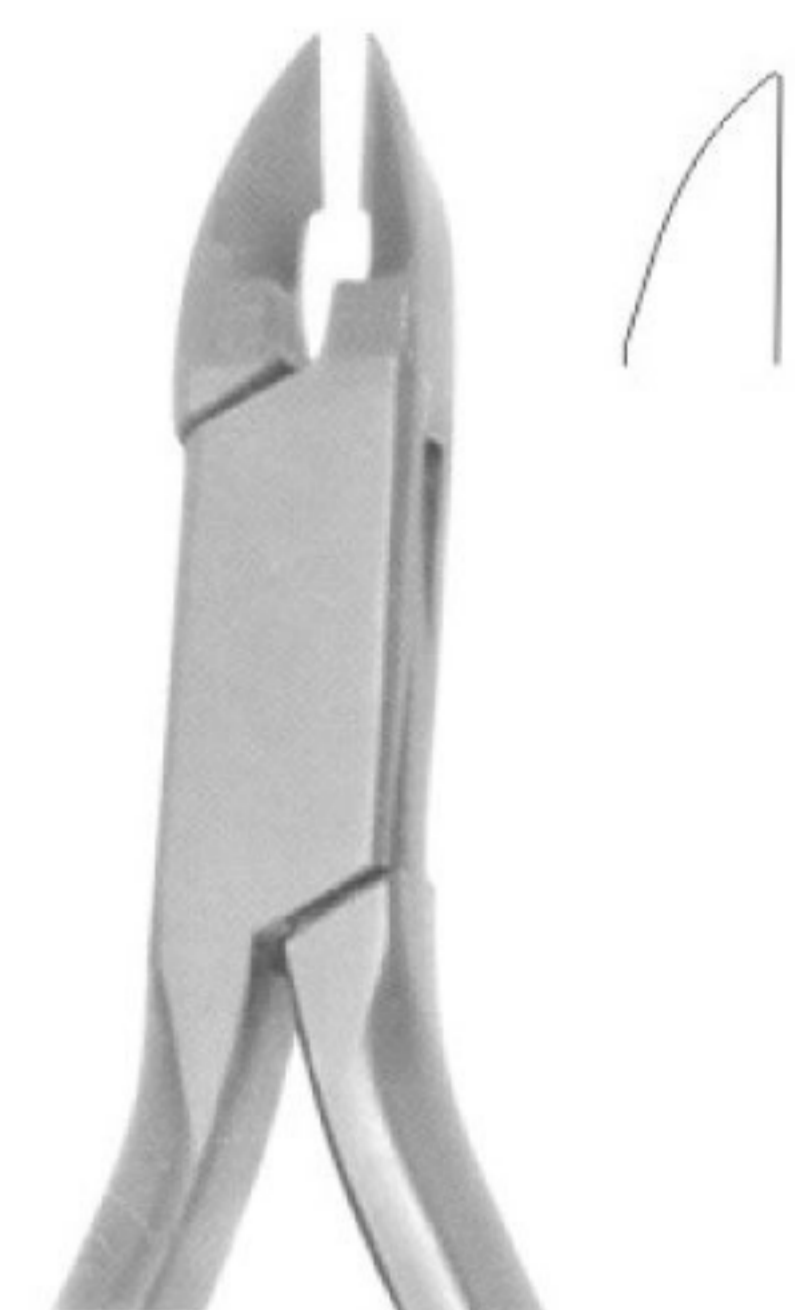

Fig. 85 TC 13 cm, 5 1/8"
MWD-2515
Fig. 85 TC 13 cm, 5 1/8"



Fig. 87 TC 13 cm, 5 1/8"
MWD-2516
 Fig. 87 TC 13 cm, 5 1/8"

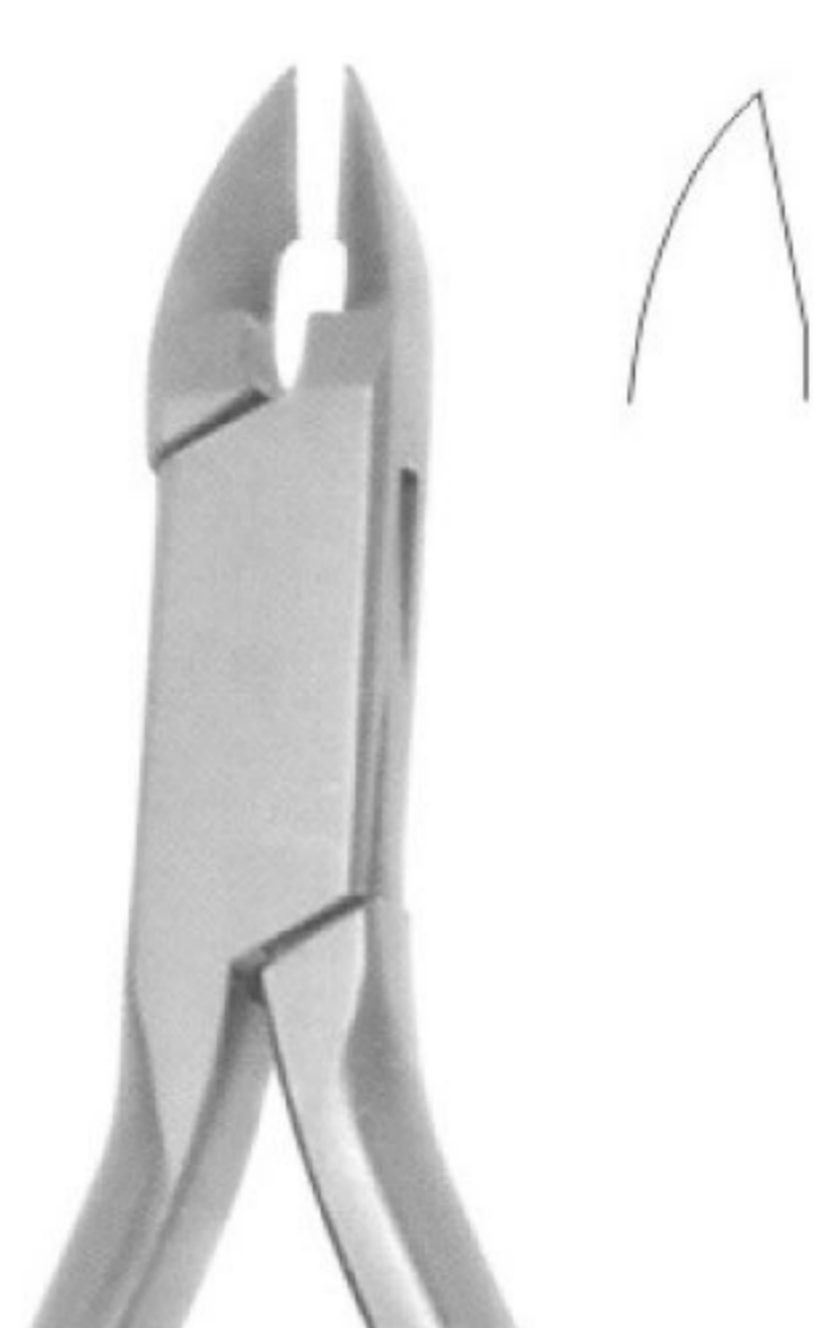
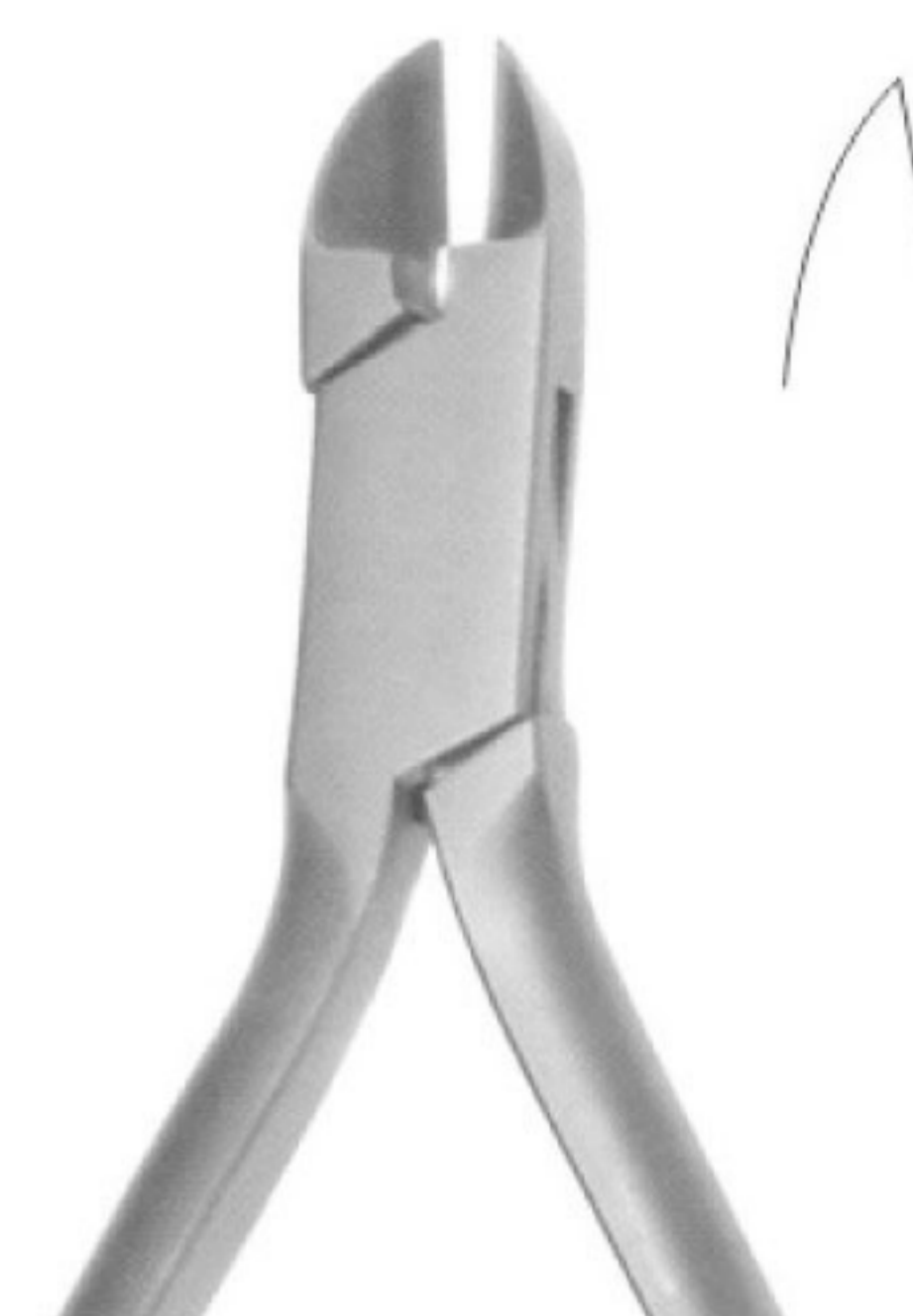

Fig. 85 TC Angled at 15 13 cm, 5 1/8"
MWD-2517
 Fig. 85 TC Angled at 15 13 cm, 5 1/8"



ADAMS 87 TC Angled at 15 13 cm, 5 1/8"
MWD-2518
 ADAMS 87 TC Angled at 15 13 cm, 5 1/8"



Fig. 89 TC
MWD-2519
 Fig. 89 TC



Fig. 64 TC 13 cm, 5 1/8"
MWD-2520
 Fig. 64 TC 13 cm, 5 1/8"



Fig. 67 TC 13 cm, 5 1/8"
MWD-2521
 Fig. 67 TC 13 cm, 5 1/8"



Fig. 88 TC 13 cm, 5 1/8"
MWD-2522
 Fig. 88 TC 13 cm, 5 1/8"



Fig. 77 TC 13 cm, 5 1/8"
MWD-2523
 Fig. 77 TC 13 cm, 5 1/8"



UNIVERSAL 150 mm
MWD-2524
 UNIVERSAL 150 mm

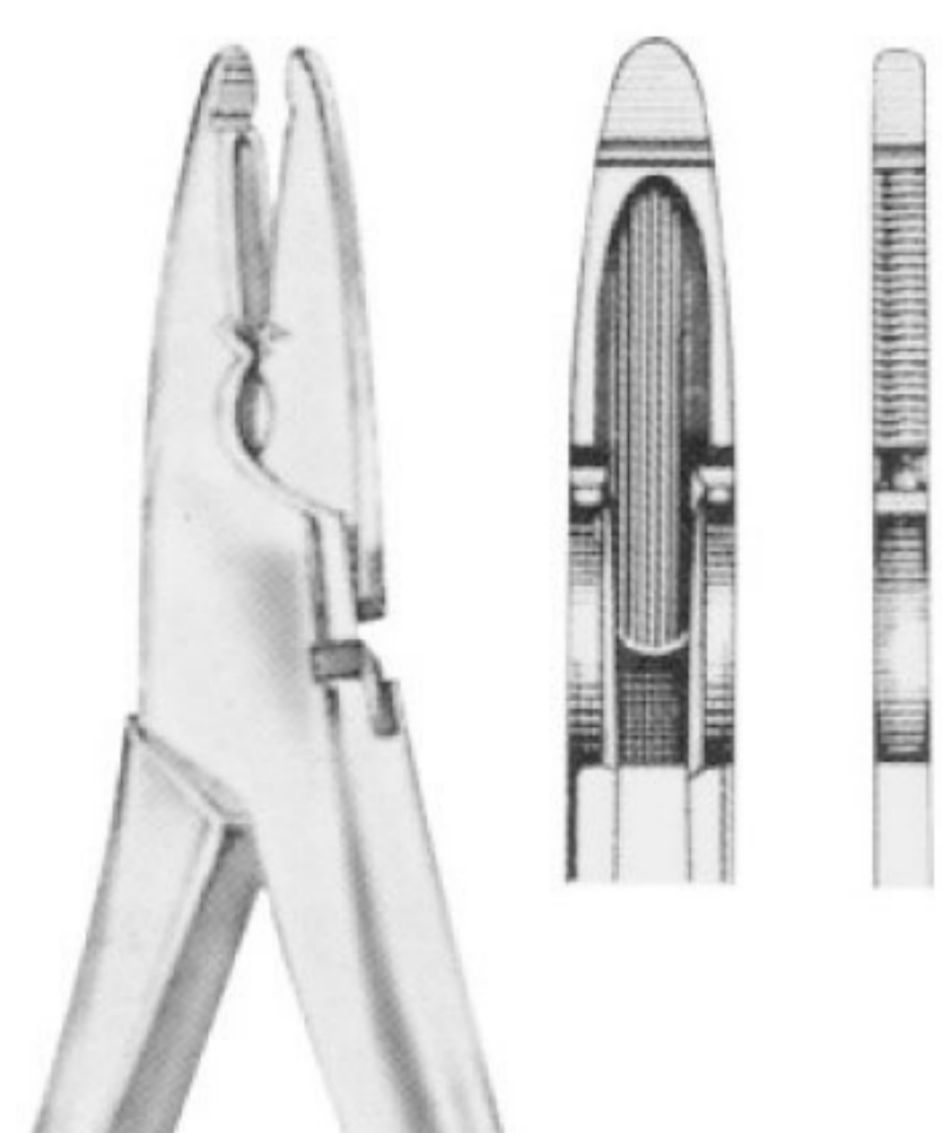

2525 WALDSACHS 155 mm
MWD-2525
 2525 WALDSACHS 155 mm



ADERER 125 mm
MWD-2526
 ADERER 125 mm



NANCE 125 mm
MWD-2527
 NANCE 125 mm

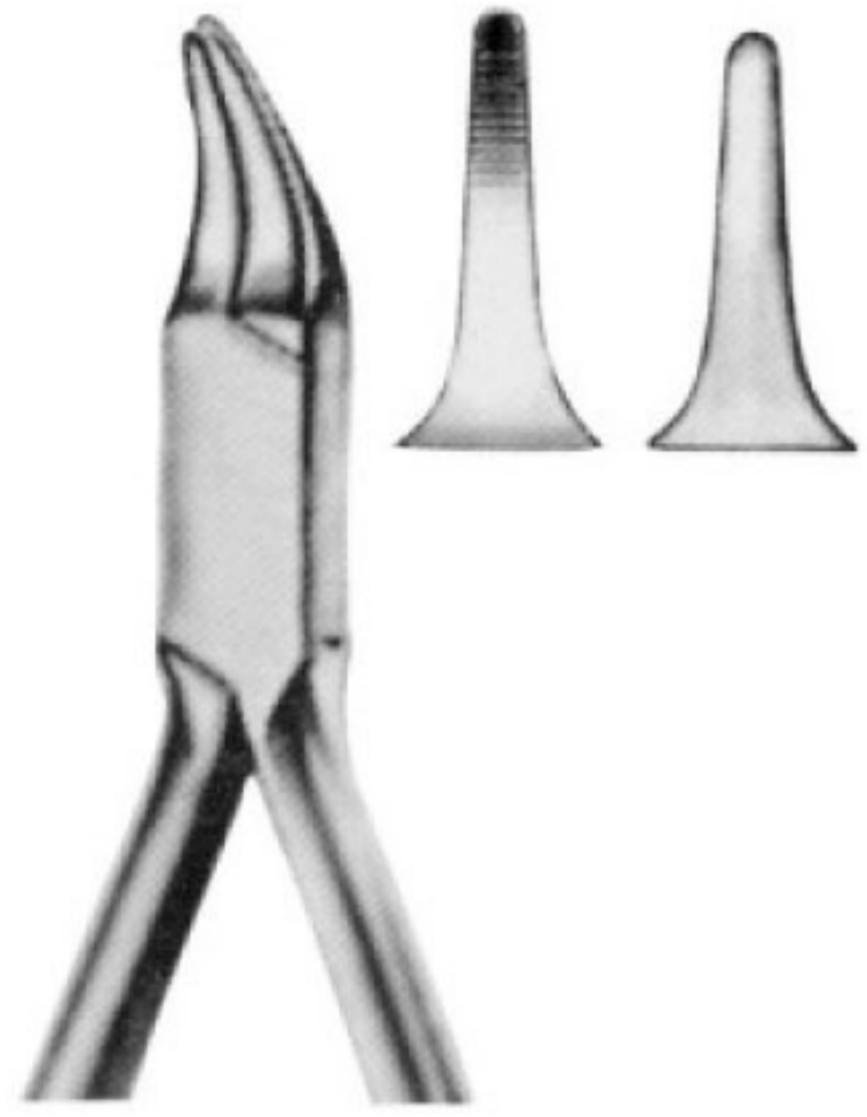

REYNOLDS 125 mm
MWD-2528
 REYNOLDS 125 mm

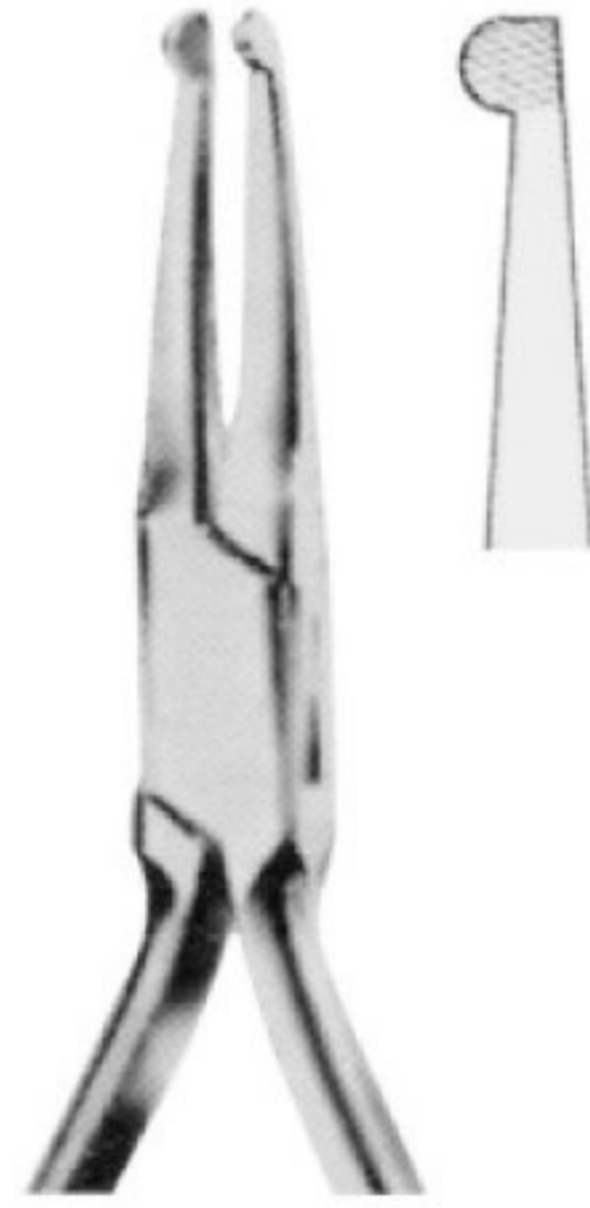

HOW 145 mm
MWD-2529
 HOW 145 mm



HOW 140 mm
MWD-2530
 HOW 140 mm

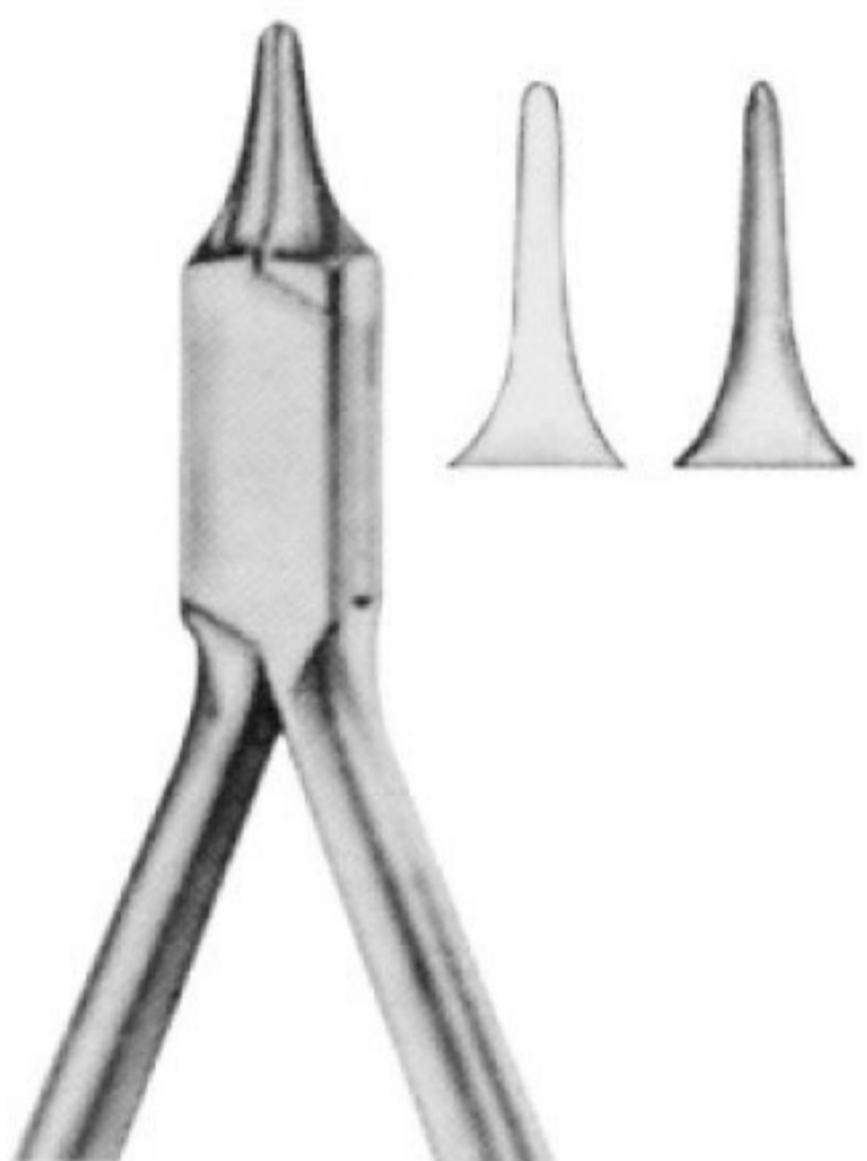

WALDRON 125 mm
MWD-2531
 WALDRON 125 mm

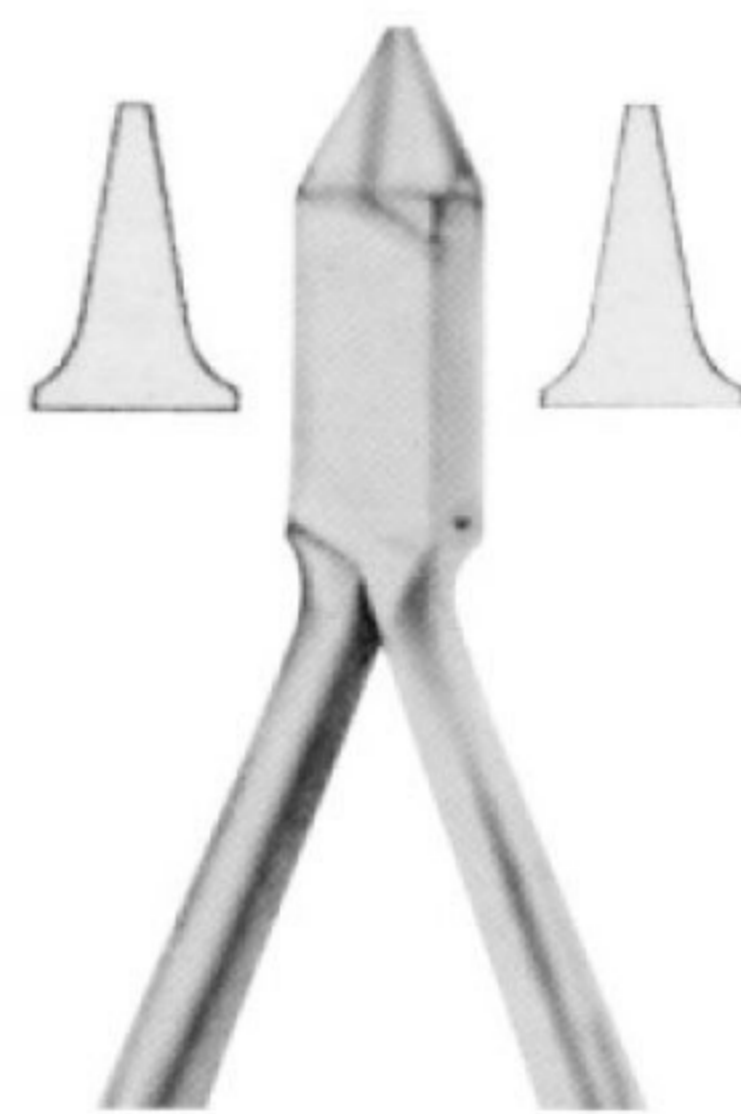

ADAMS 125 mm
MWD-2532
 ADAMS 125 mm

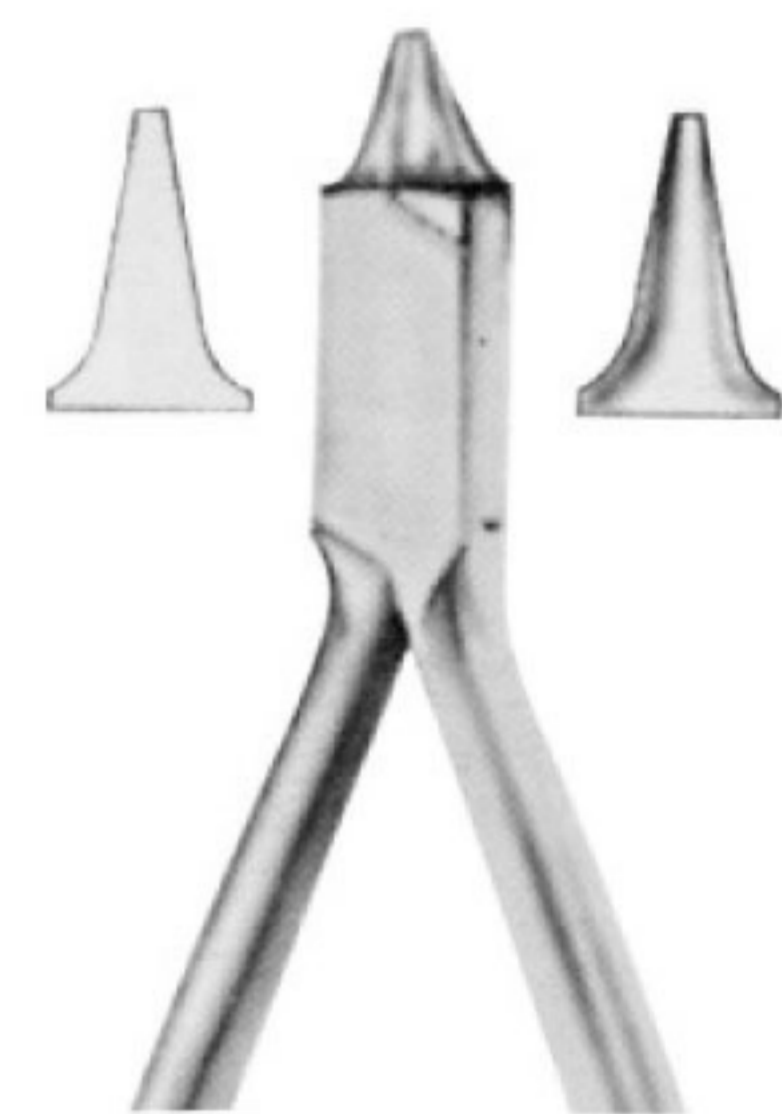

ANGLE 125 mm
MWD-2533
 ANGLE 125 mm



FURRER 150 mm
MWD-2534
 FURRER 150 mm

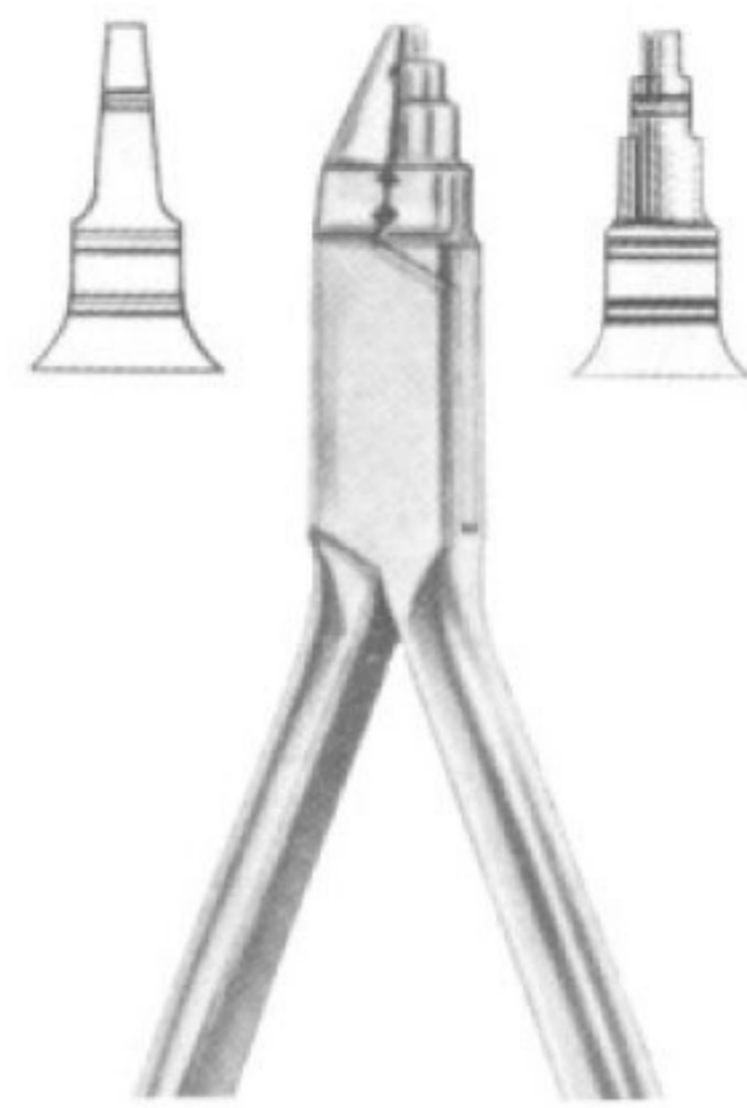

YOUNG 130 mm
MWD-2535
 YOUNG 130 mm

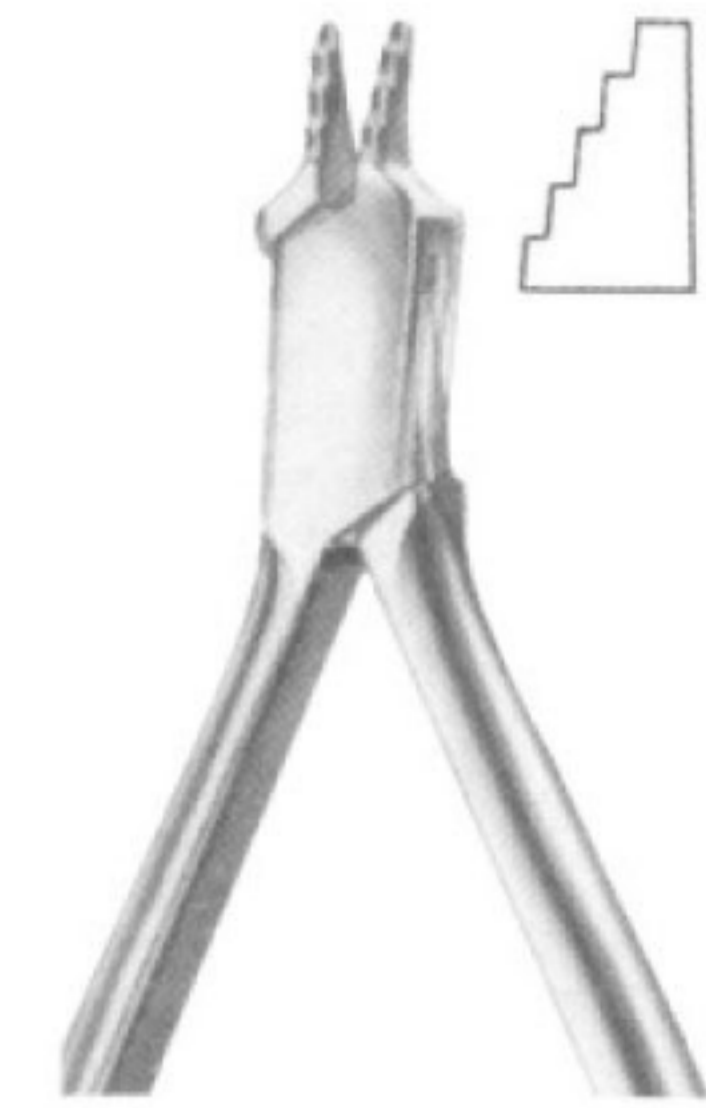

NANCE 130 mm
MWD-2536
 NANCE 130 mm

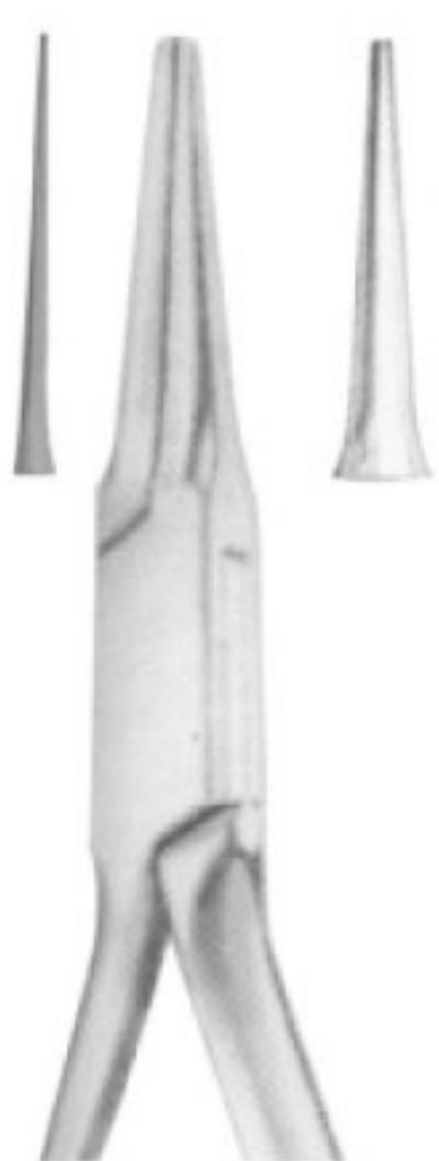

LANGEBECK 125 mm
MWD-2537
 LANGEBECK 125 mm

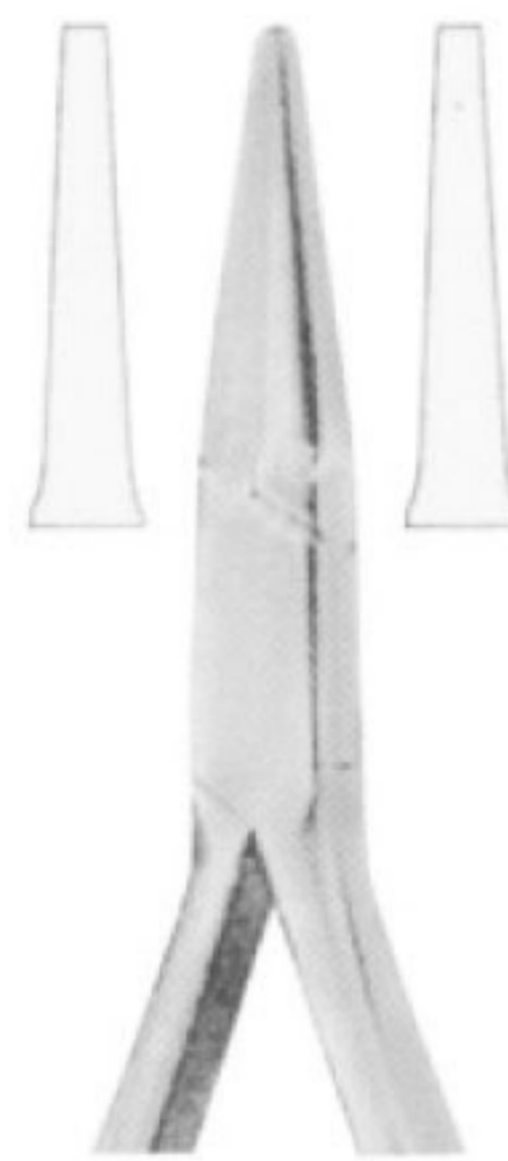

LANGEBECK 140 mm
MWD-2538
 LANGEBECK 140 mm

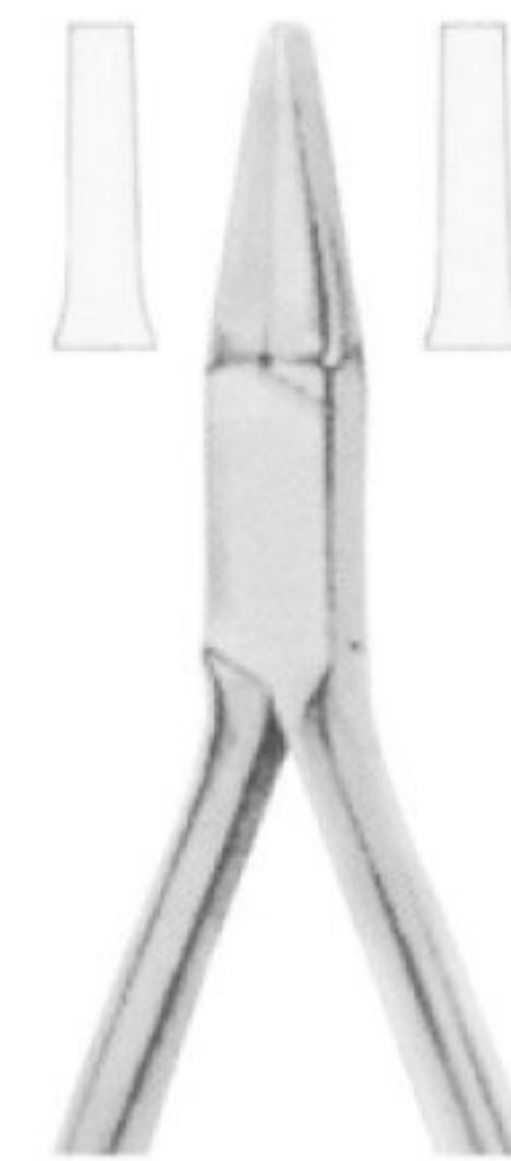

LANGEBECK 130 mm
MWD-2539
 LANGEBECK 130 mm

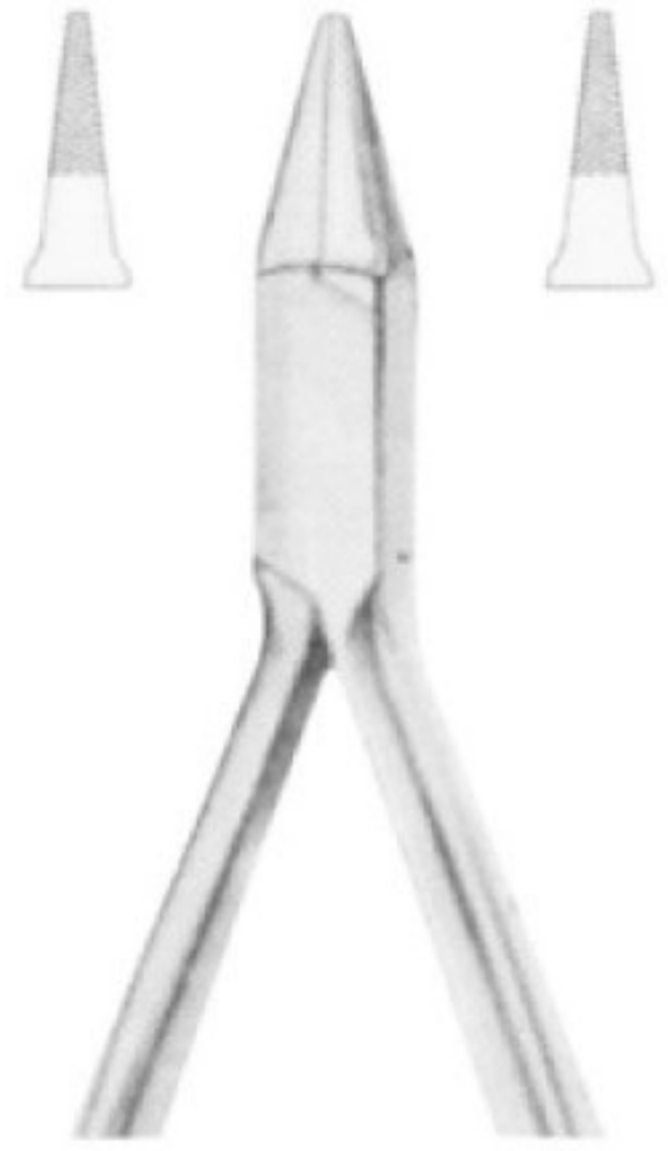

PEESO 125 mm
MWD-2540
 PEESO 125 mm

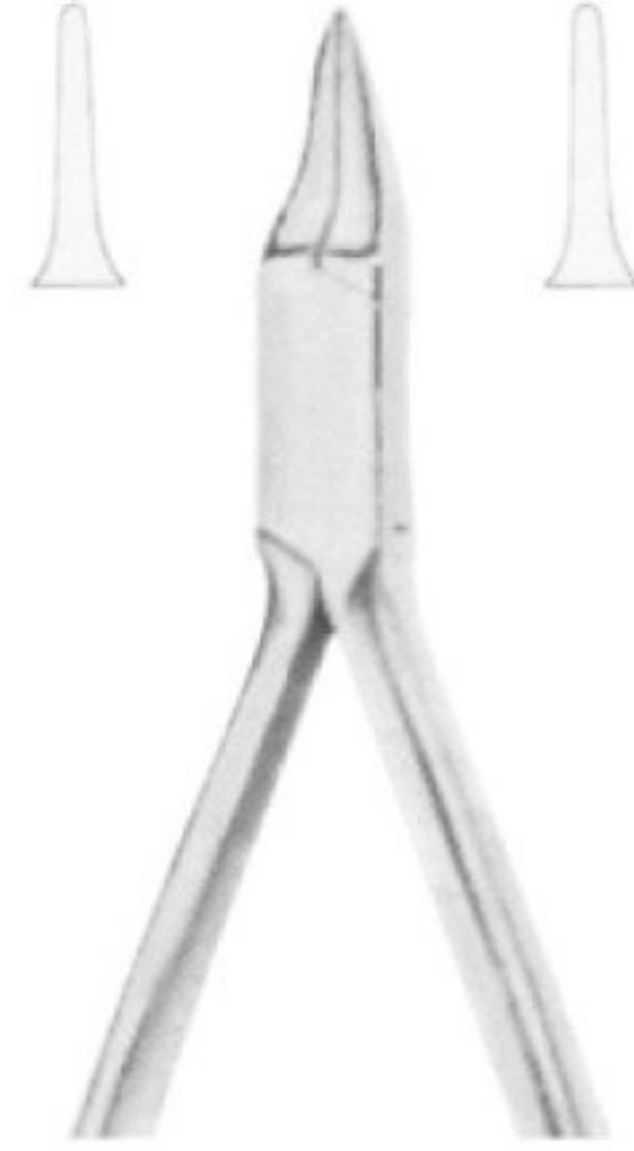

GOSLEE 125 mm
MWD-2541
 GOSLEE 125 mm

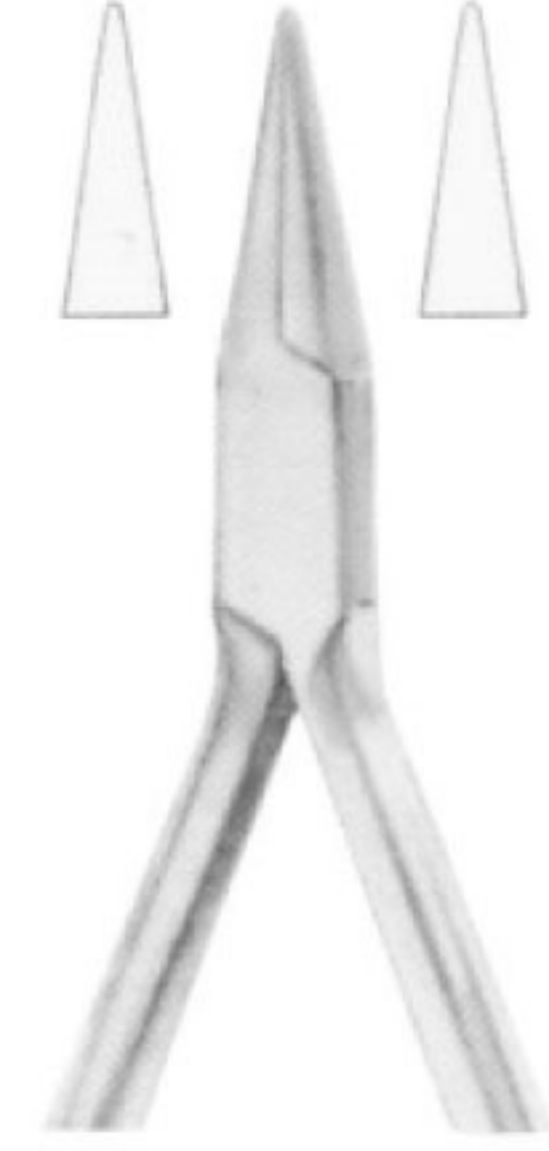

FISCHER 140 mm
MWD-2542
 FISCHER 140 mm



FISCHER 140 mm
MWD-2543
 FISCHER 140 mm



JOHNSON 130 mm
MWD-2544
 JOHNSON 130 mm

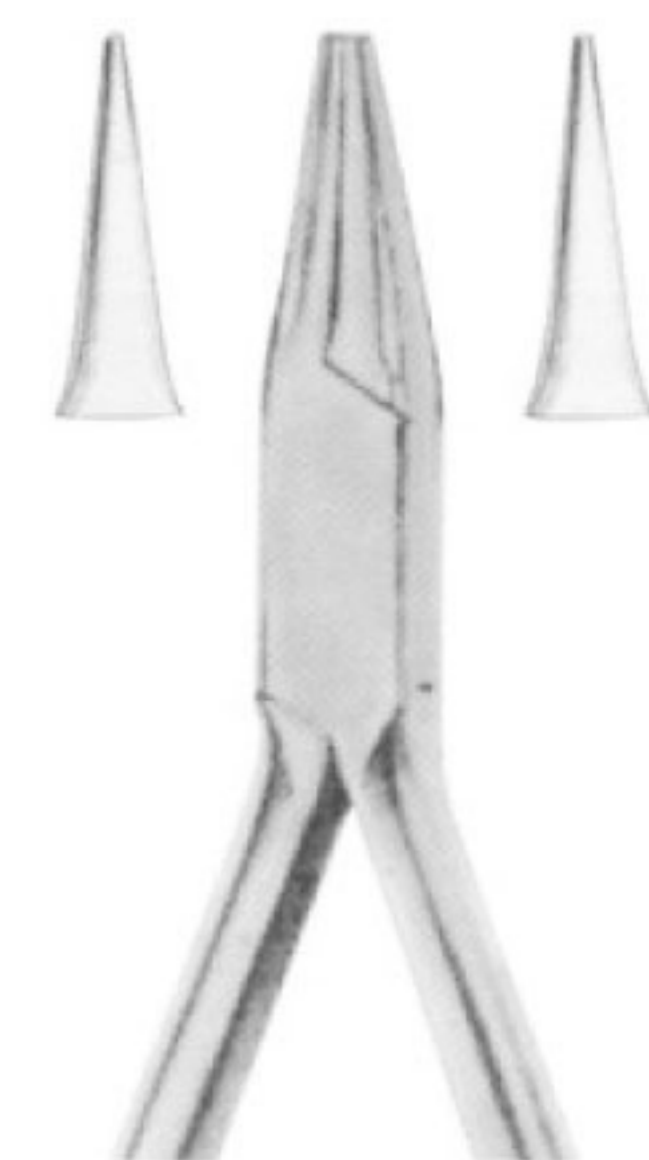

MSY 130 mm
MWD-2545
 MSY 130 mm

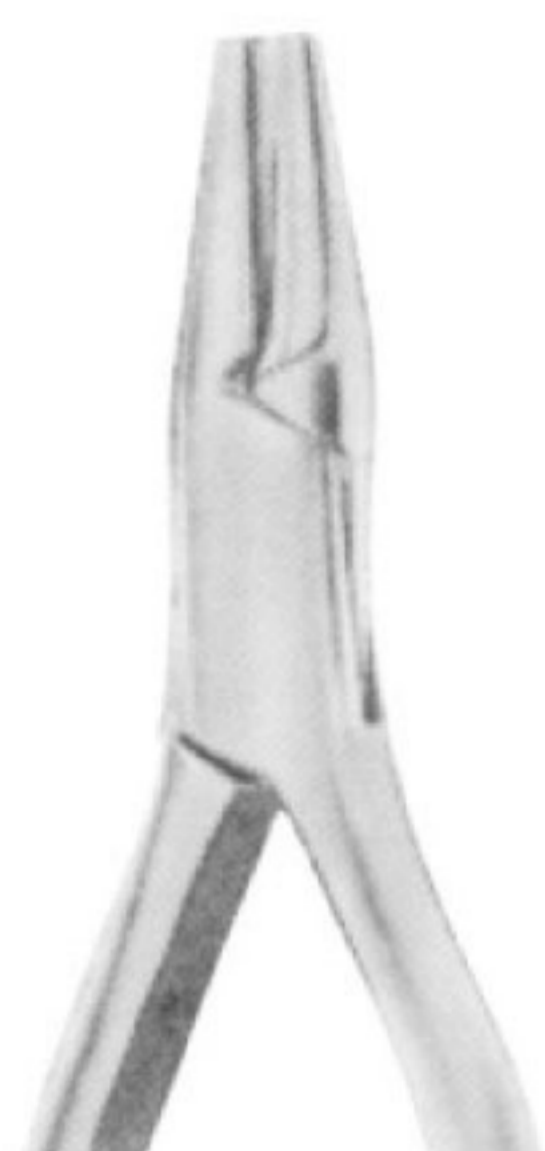

MC KELLOPS 155 mm
MWD-2546
 MC KELLOPS 155 mm

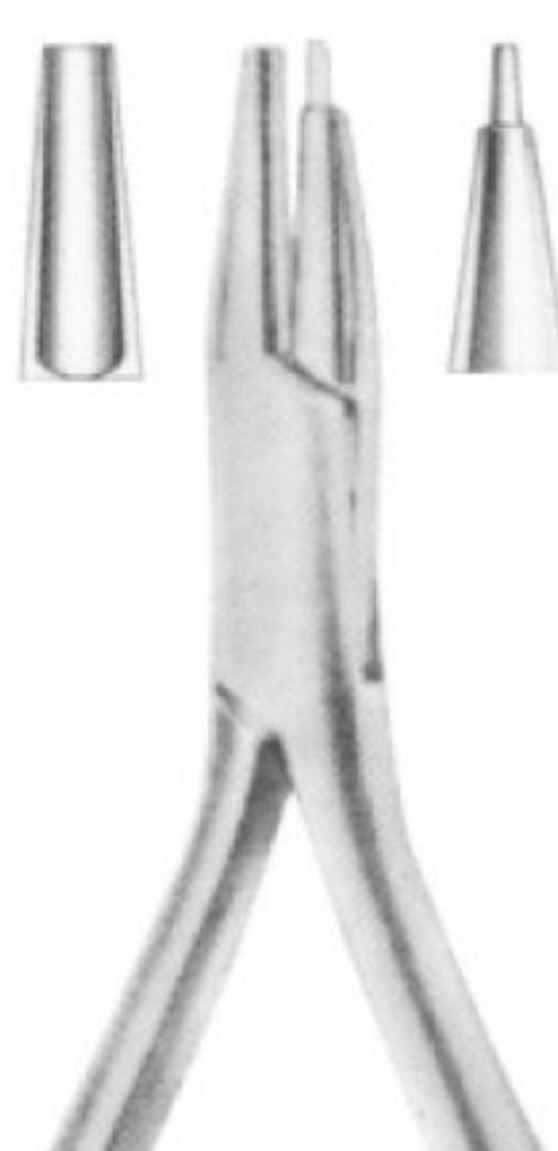

ANDRESEN 130 mm
MWD-2547
 ANDRESEN 130 mm

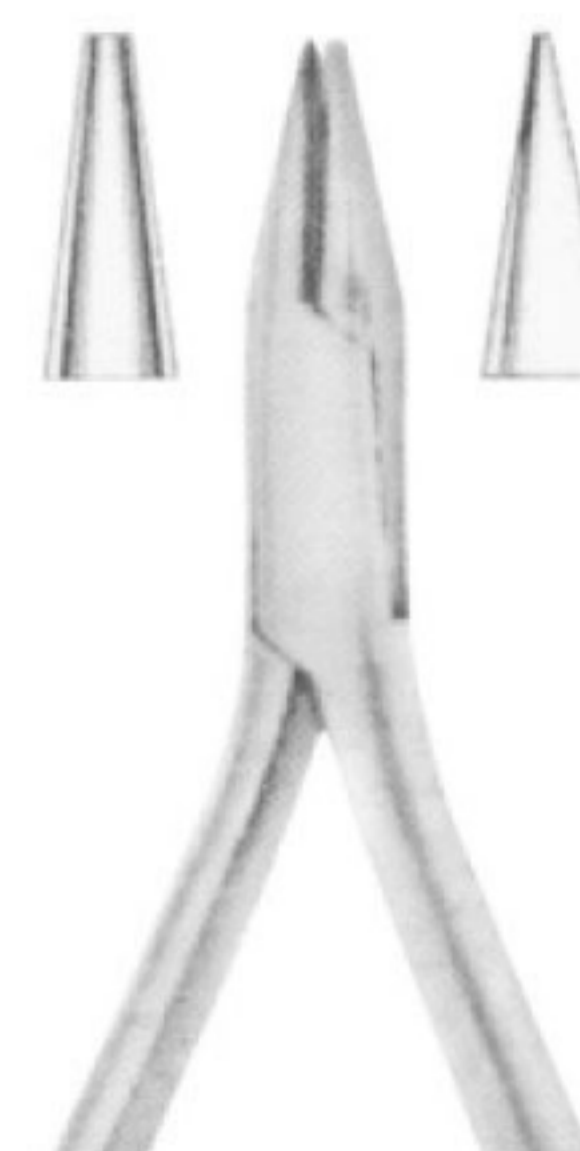

SCHWARZ 130 mm
MWD-2548
 SCHWARZ 130 mm



BLUMENTHAL 6", 30 , Standard o
MWD-2549
 BLUMENTHAL 6", 30 , Standard o

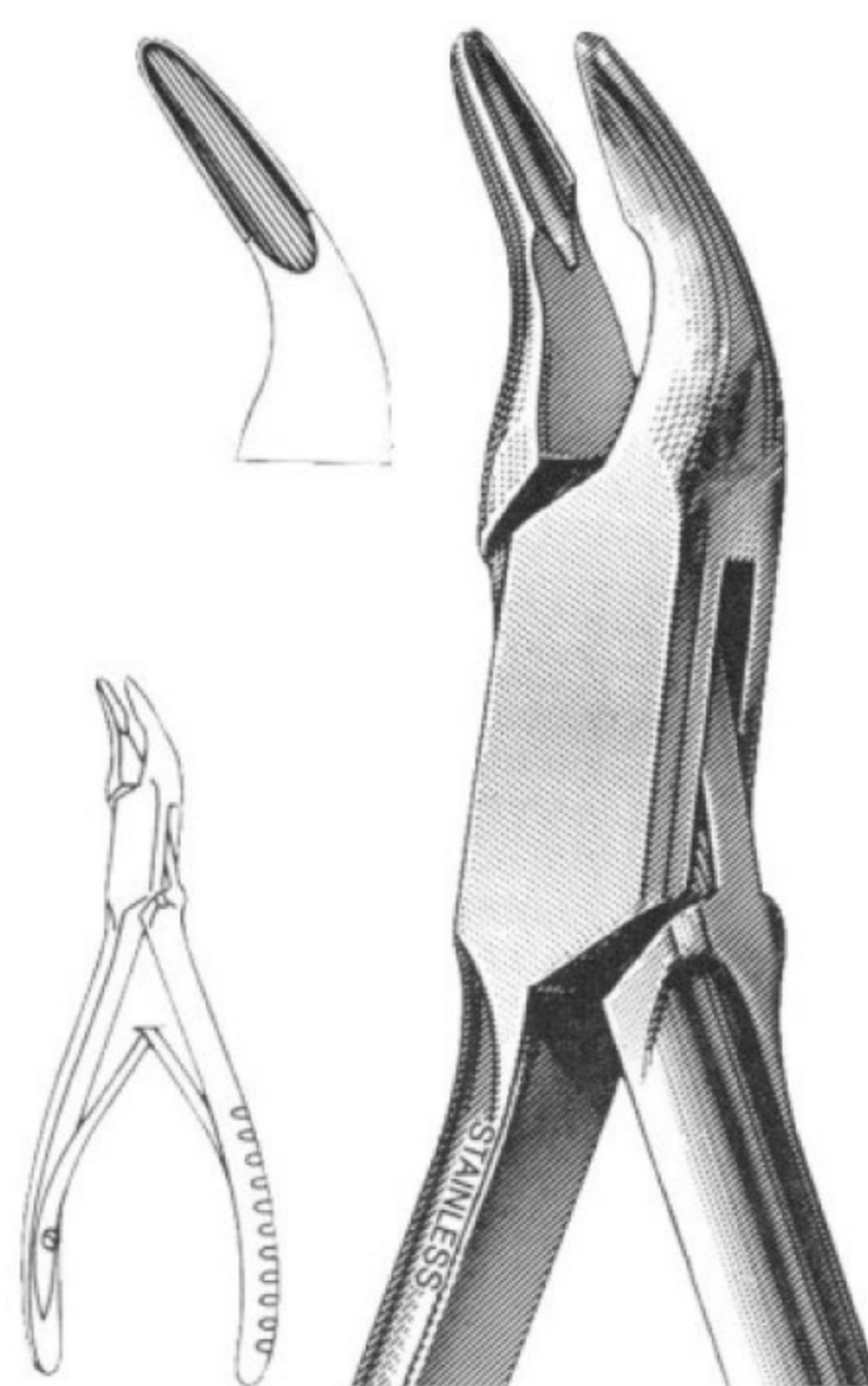

MINI-BLUMENTHAL 6", 45
MWD-2550
 MINI-BLUMENTHAL 6", 45

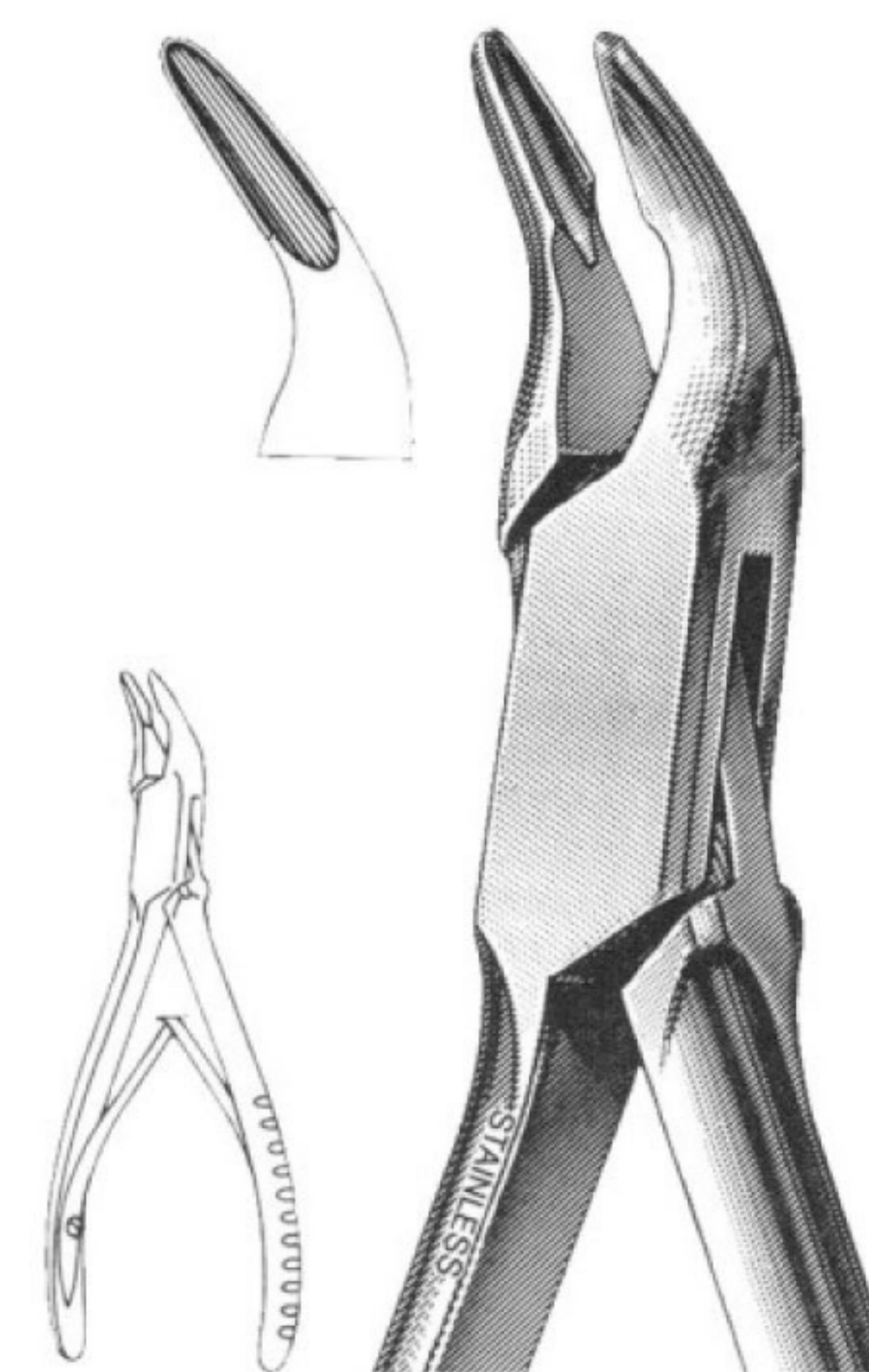

MINI-BLUMENTHAL 6", 90
MWD-2551
 MINI-BLUMENTHAL 6", 90

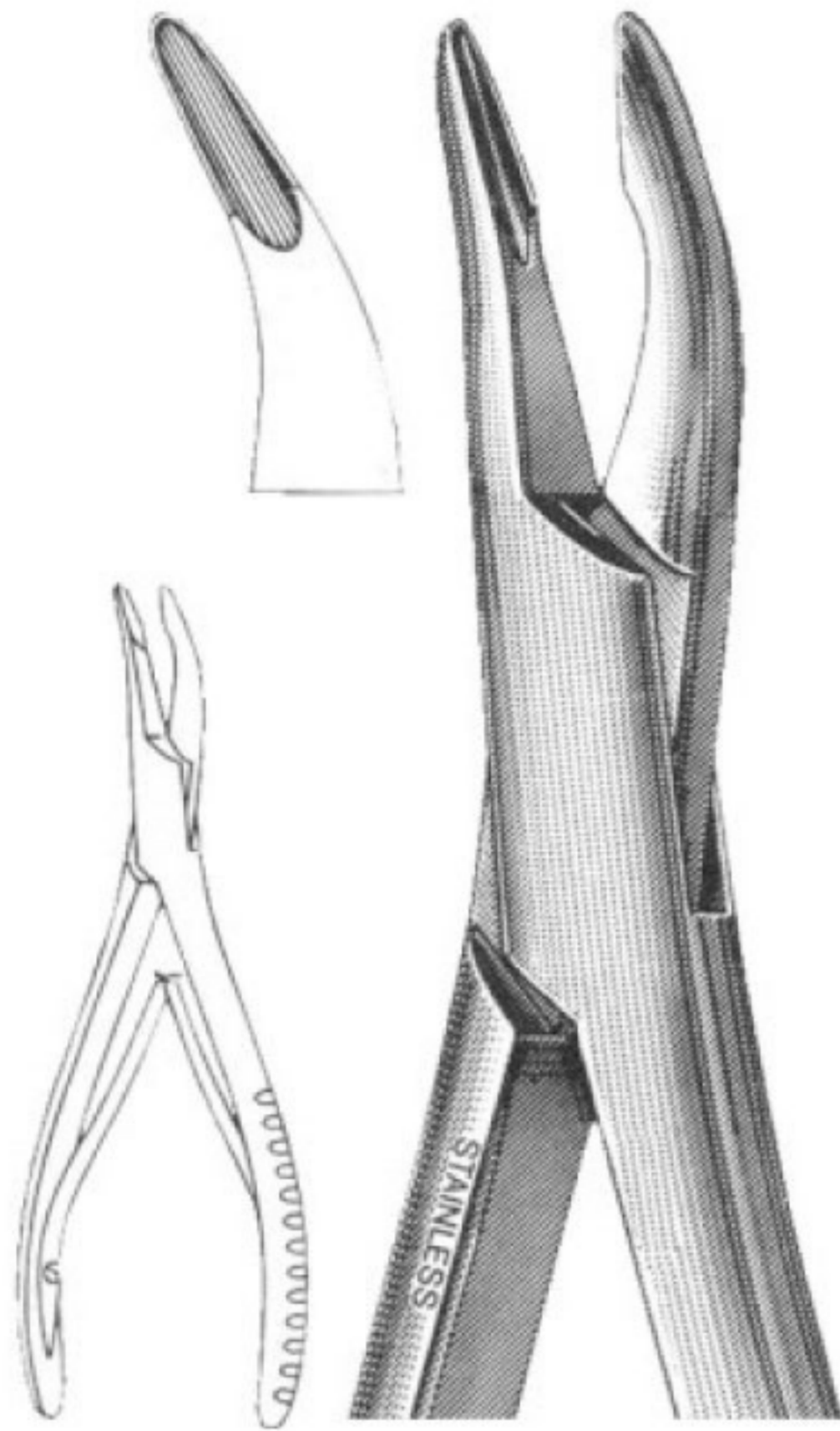

BLUMENTHAL 7", 30
MWD-2552
 BLUMENTHAL 7", 30

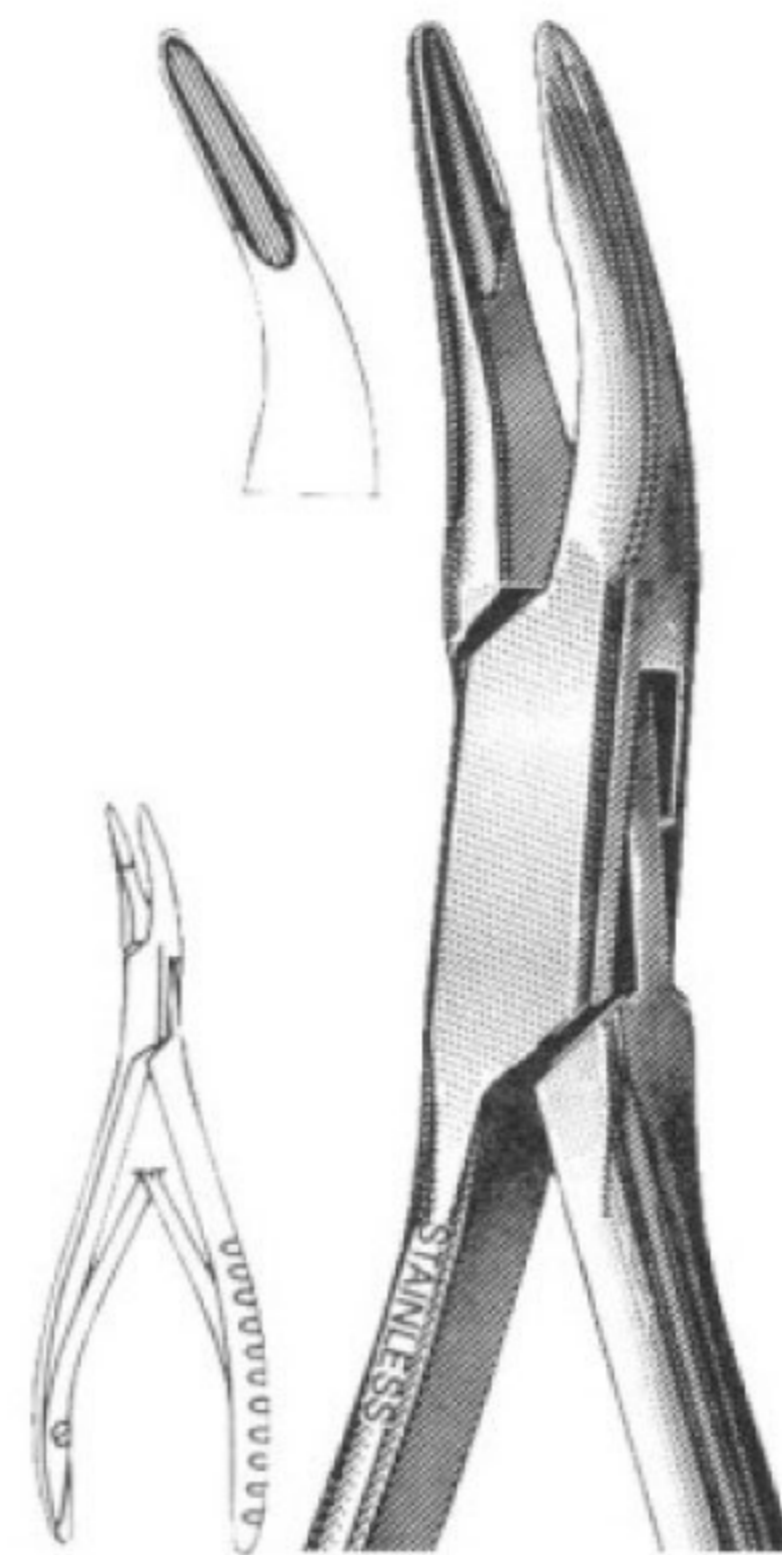

MINI-BLUMENTHAL 4 1/2", 30
MWD-2553
 MINI-BLUMENTHAL 4 1/2", 30

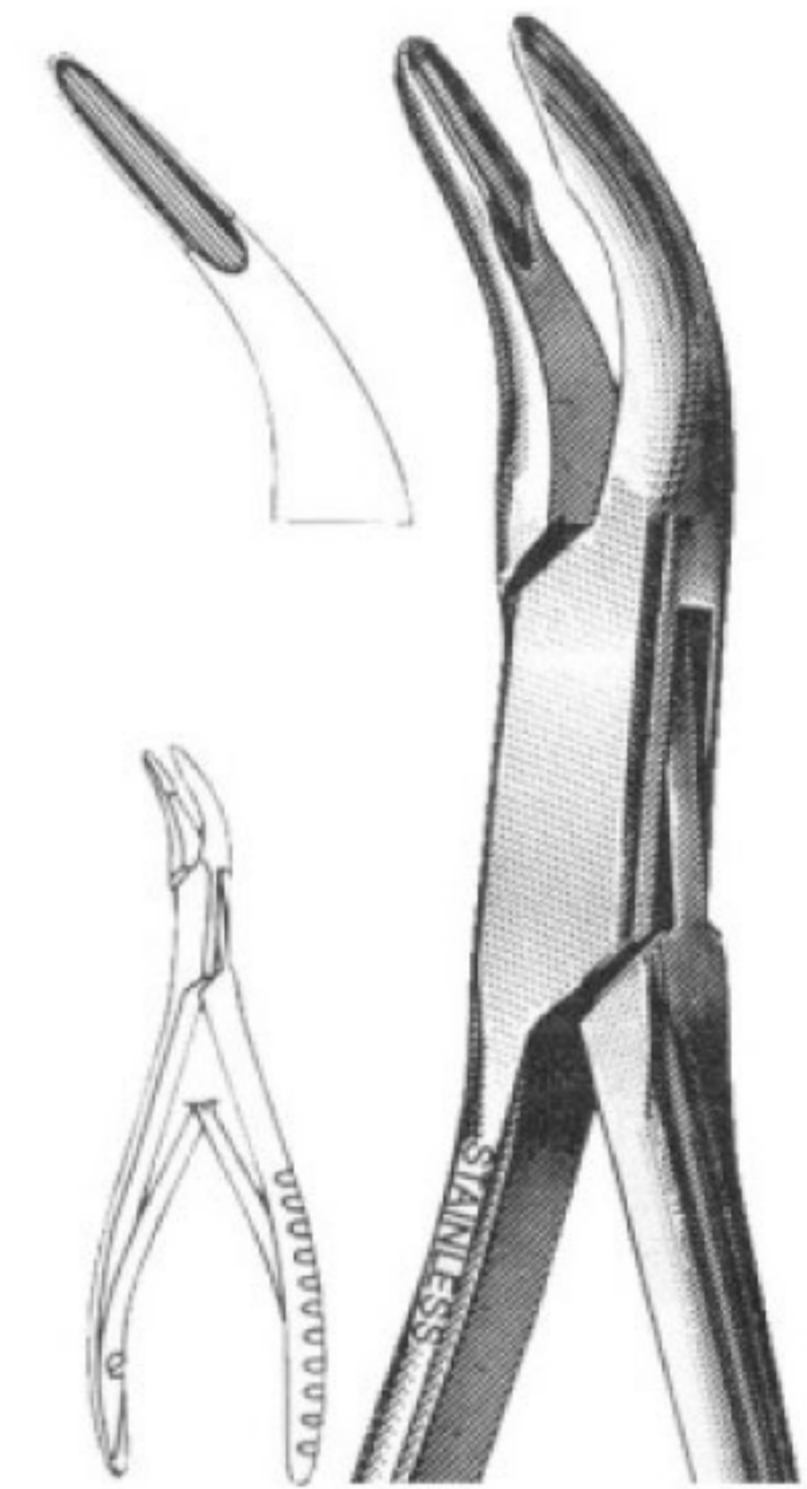

MINI-BLUMENTHAL 4 1/2", 45
MWD-2554
 MINI-BLUMENTHAL 4 1/2", 45



CLEVELAND No. 5-Side Cutting, 6 3/4"
MWD-2555
 CLEVELAND No. 5-Side Cutting, 6 3/4"

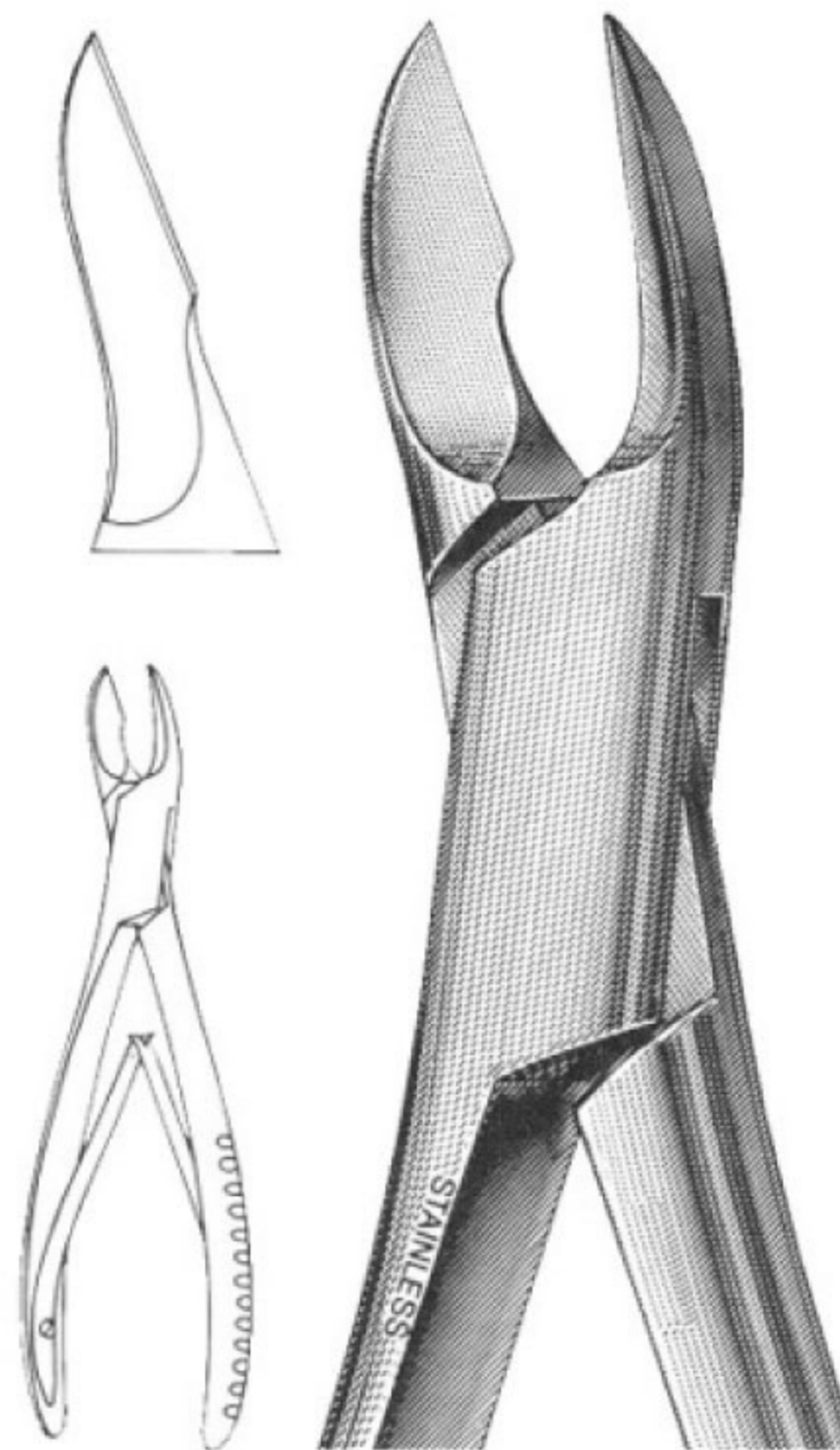

CLEVELAND No. 5A-Side Cutting, 6 1/2"
MWD-2556
 CLEVELAND No. 5A-Side Cutting, 6 1/2"

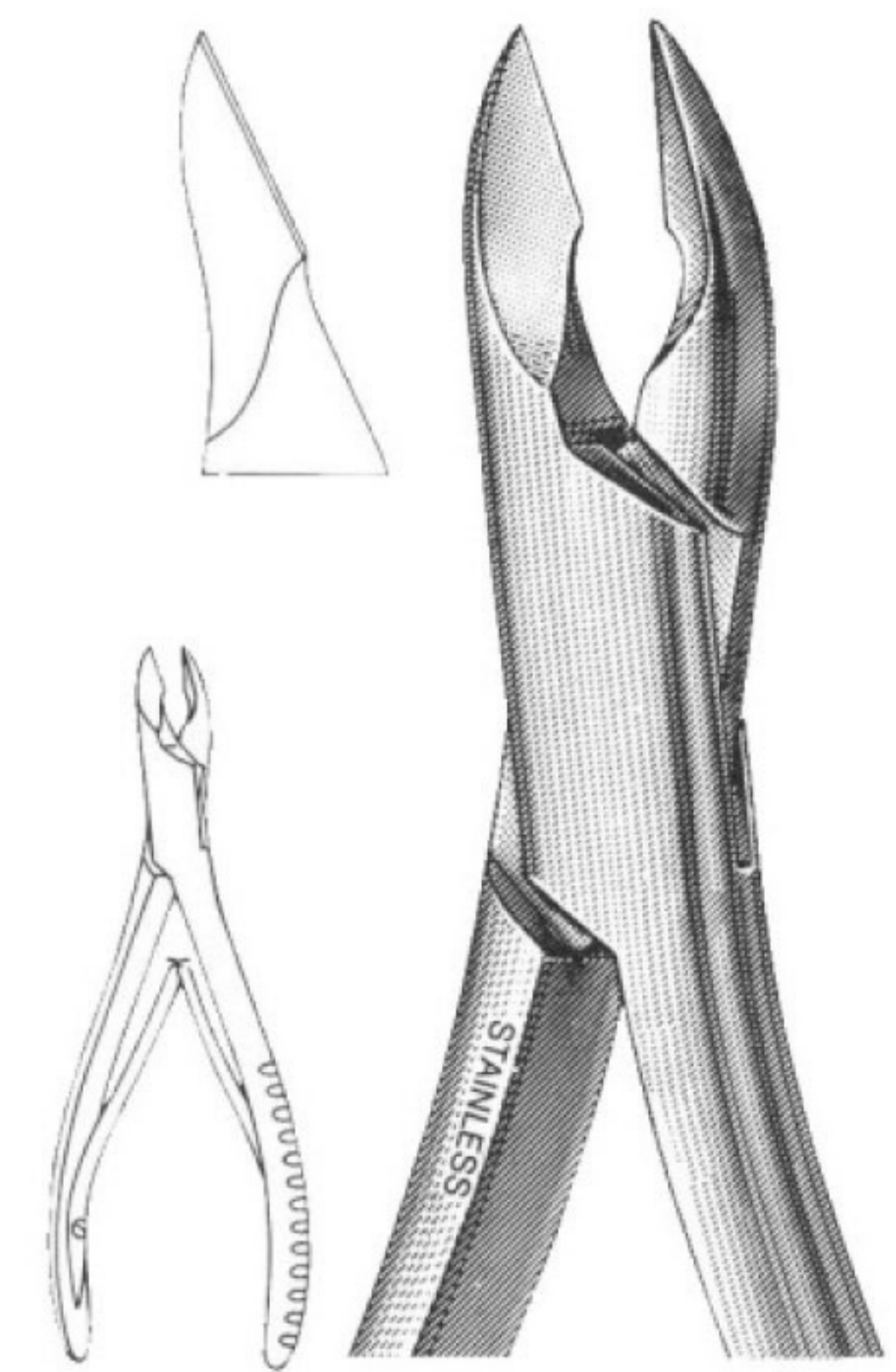

CLEVELAND No. 5S-Side Cutting, 6"
MWD-2557
 CLEVELAND No. 5S-Side Cutting, 6"

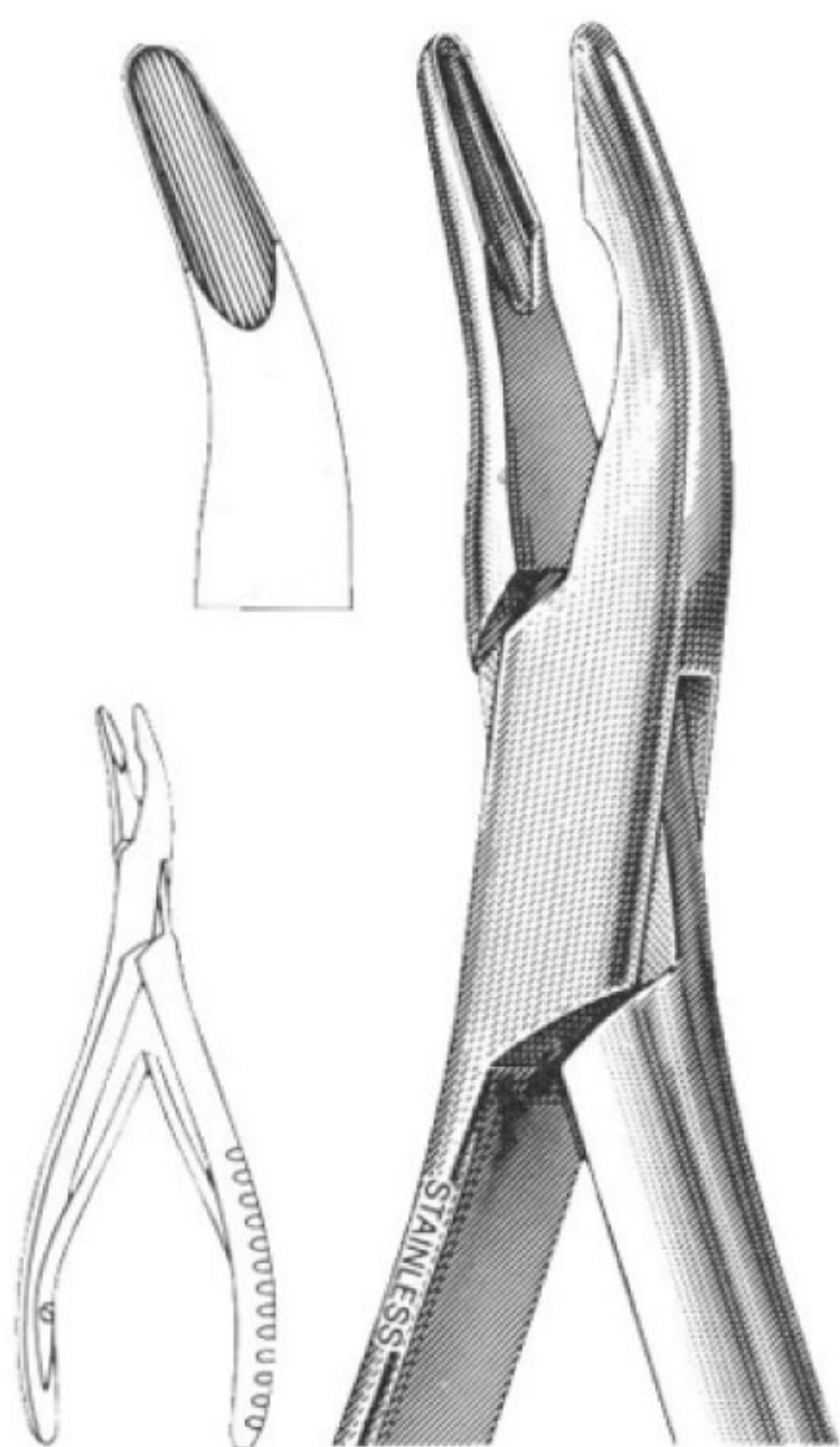

No. 1A-MEAD 6 1/2"
MWD-2558
 No. 1A-MEAD 6 1/2"

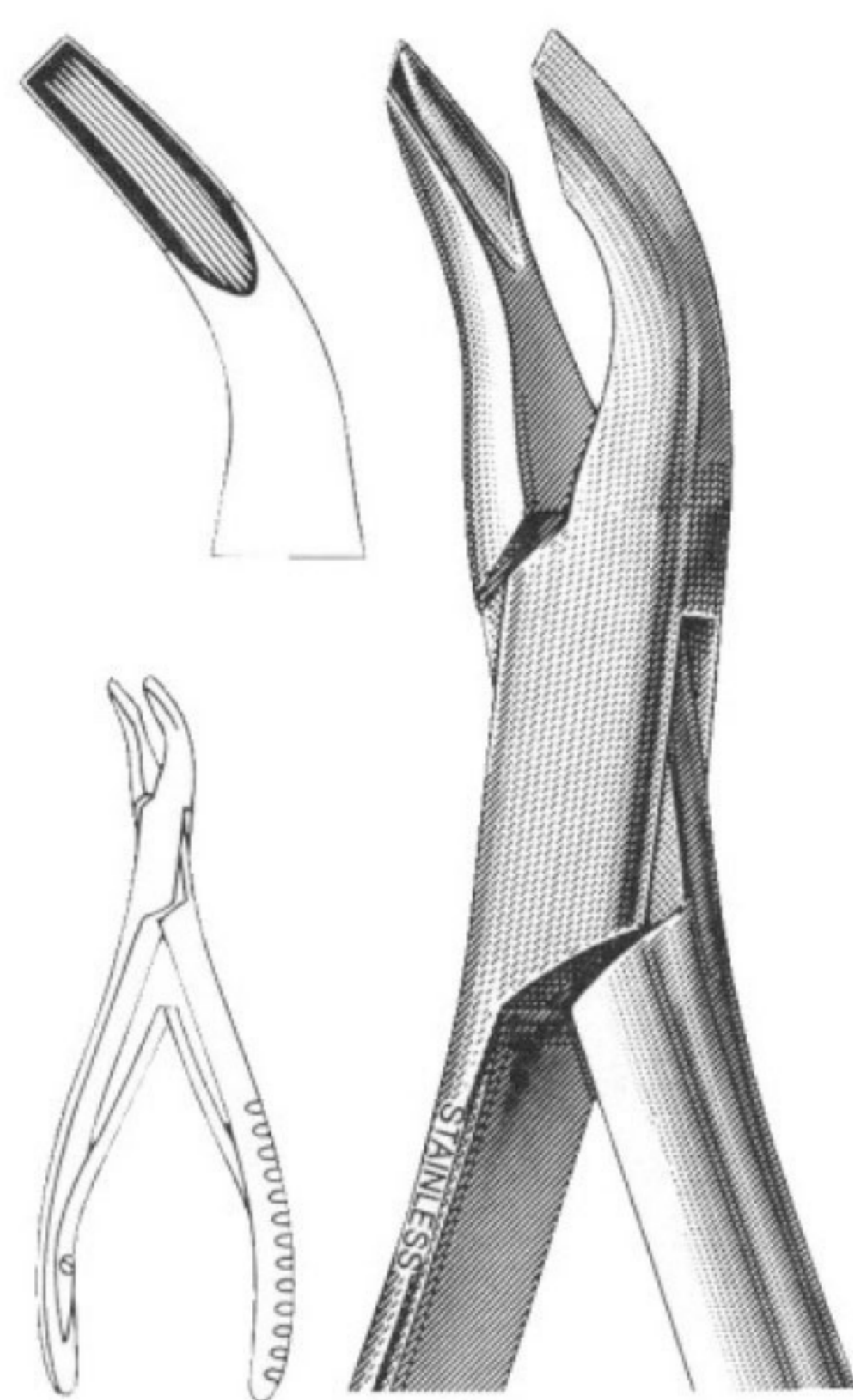

MEAD, Square No. 2A Tips, 6 1/2"
MWD-2559
 MEAD, Square No. 2A Tips, 6 1/2"



FRIEDMAN 5 1/2"
MWD-2560
 FRIEDMAN 5 1/2"

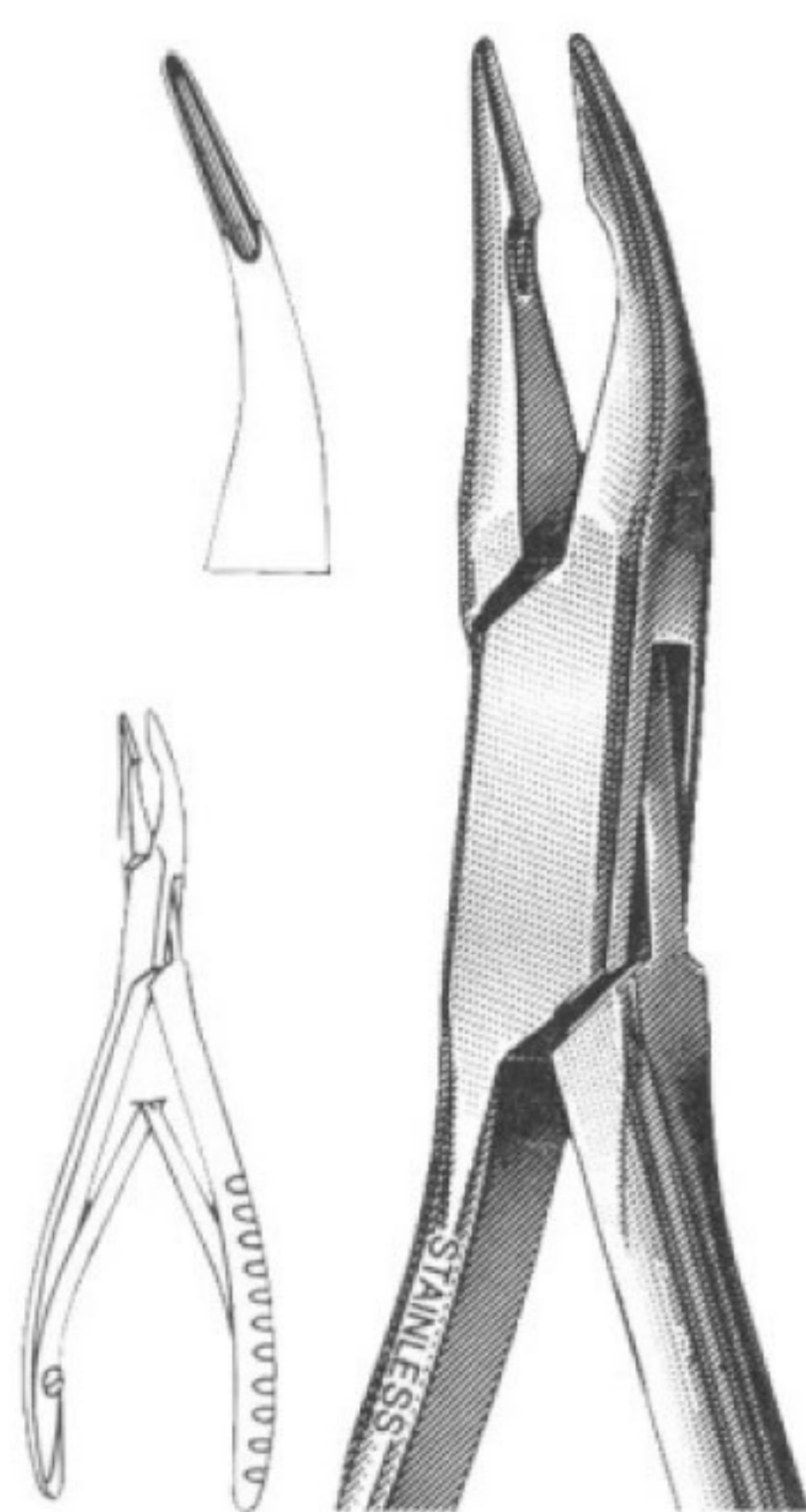

MICRO-FRIEDMAN 5 1/2", 15 Curved Jaws
MWD-2561
 MICRO-FRIEDMAN 5 1/2", 15

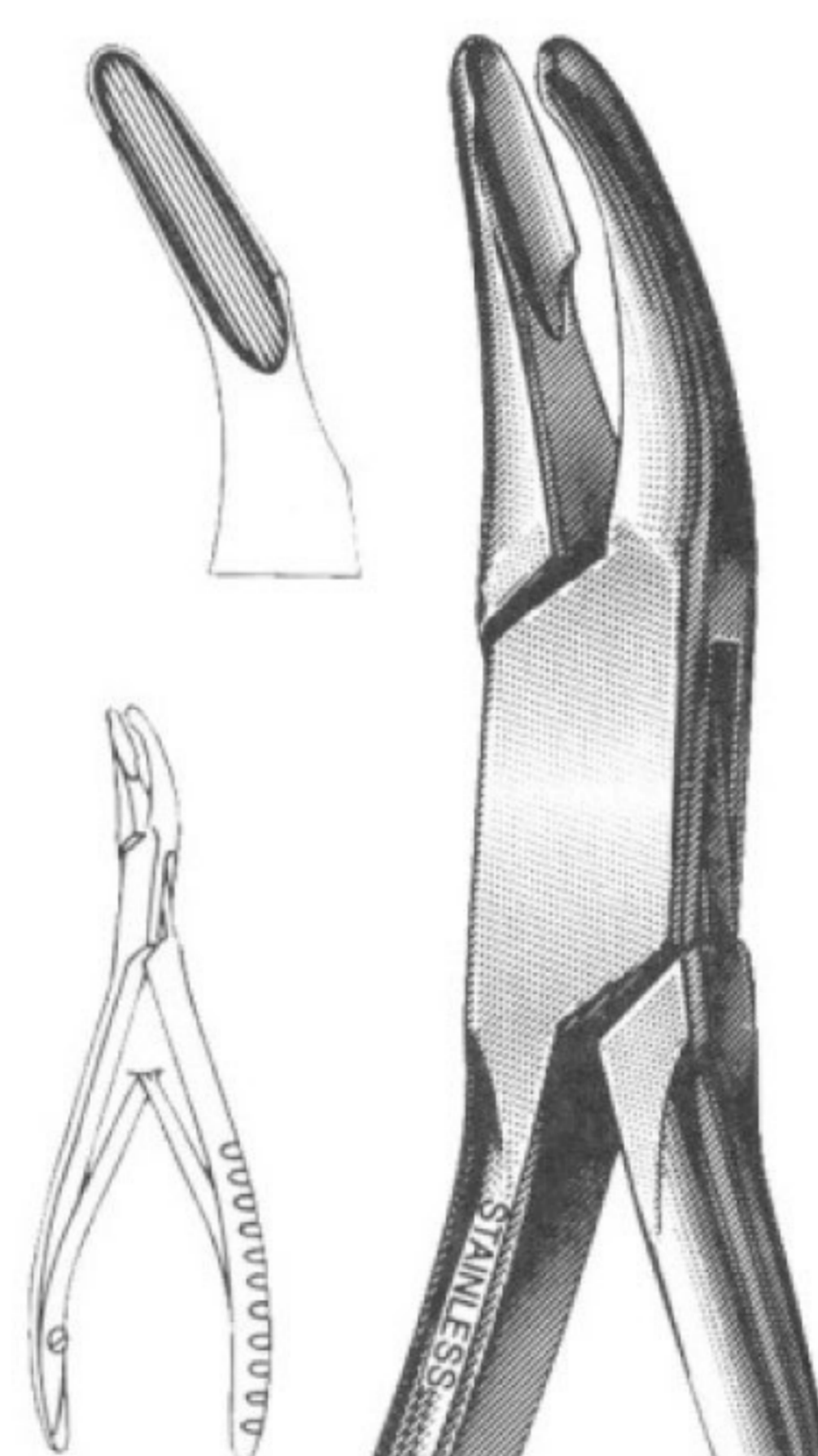

CLEVELAND No. 4 - 5 1/2"
MWD-2563
 CLEVELAND No. 4 - 5 1/2"

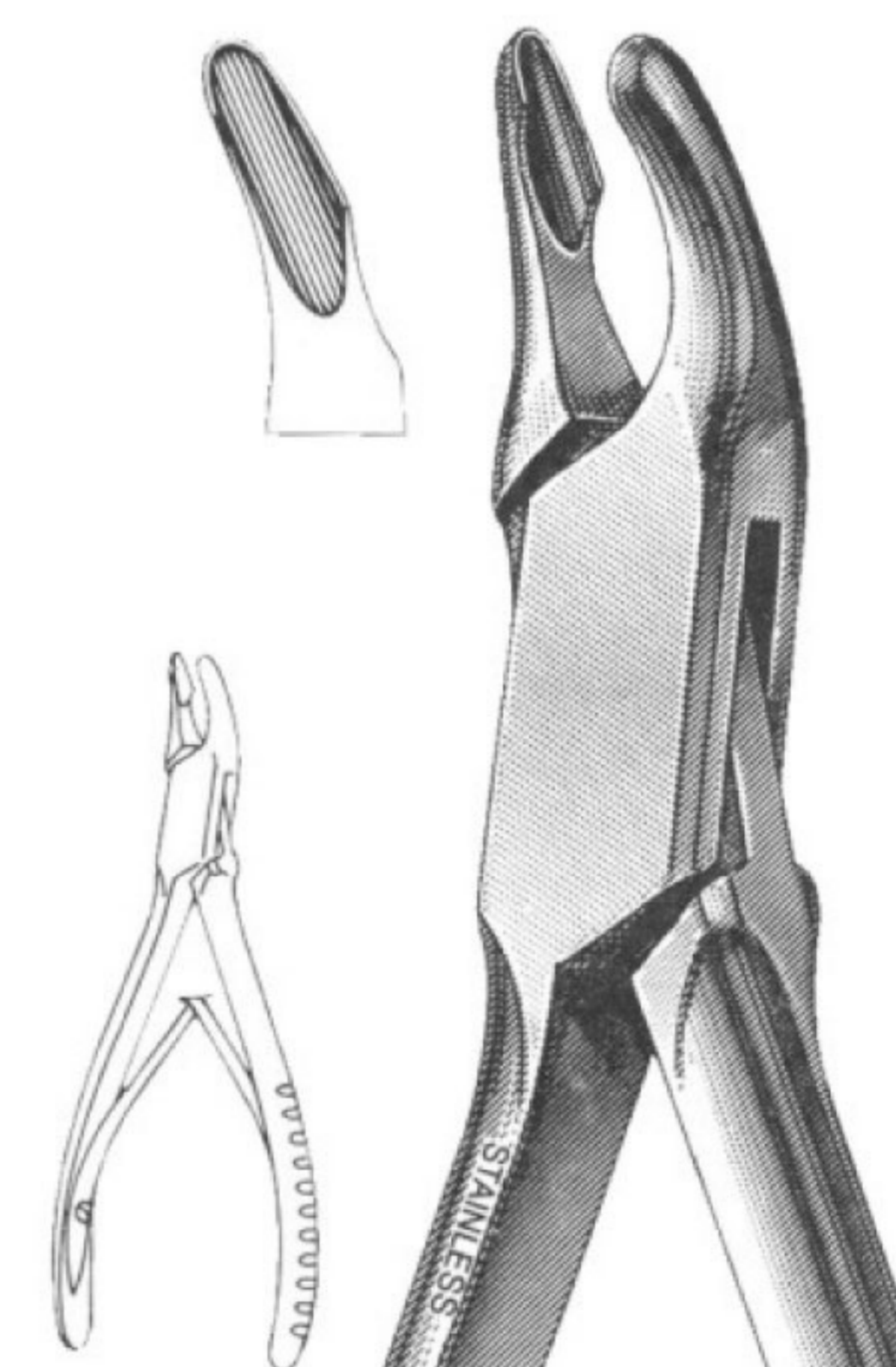

CLEVELAND No. 4A - 6 1/2"
MWD-2564
 CLEVELAND No. 4A - 6 1/2"

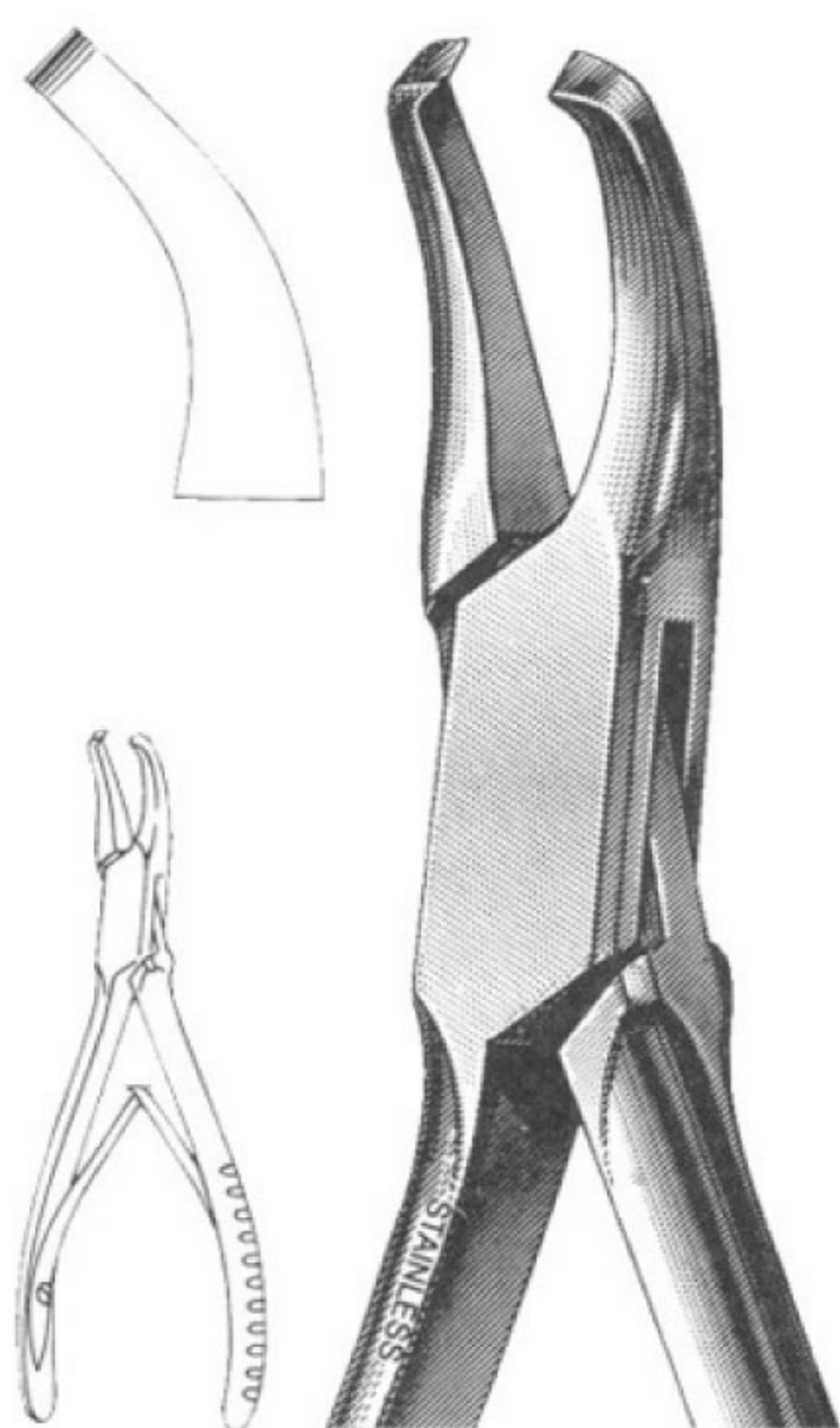

GARDNER No. 6A, End Cutting 6 1/2"
MWD-2565
 GARDNER No. 6A, End Cutting 6 1/2"

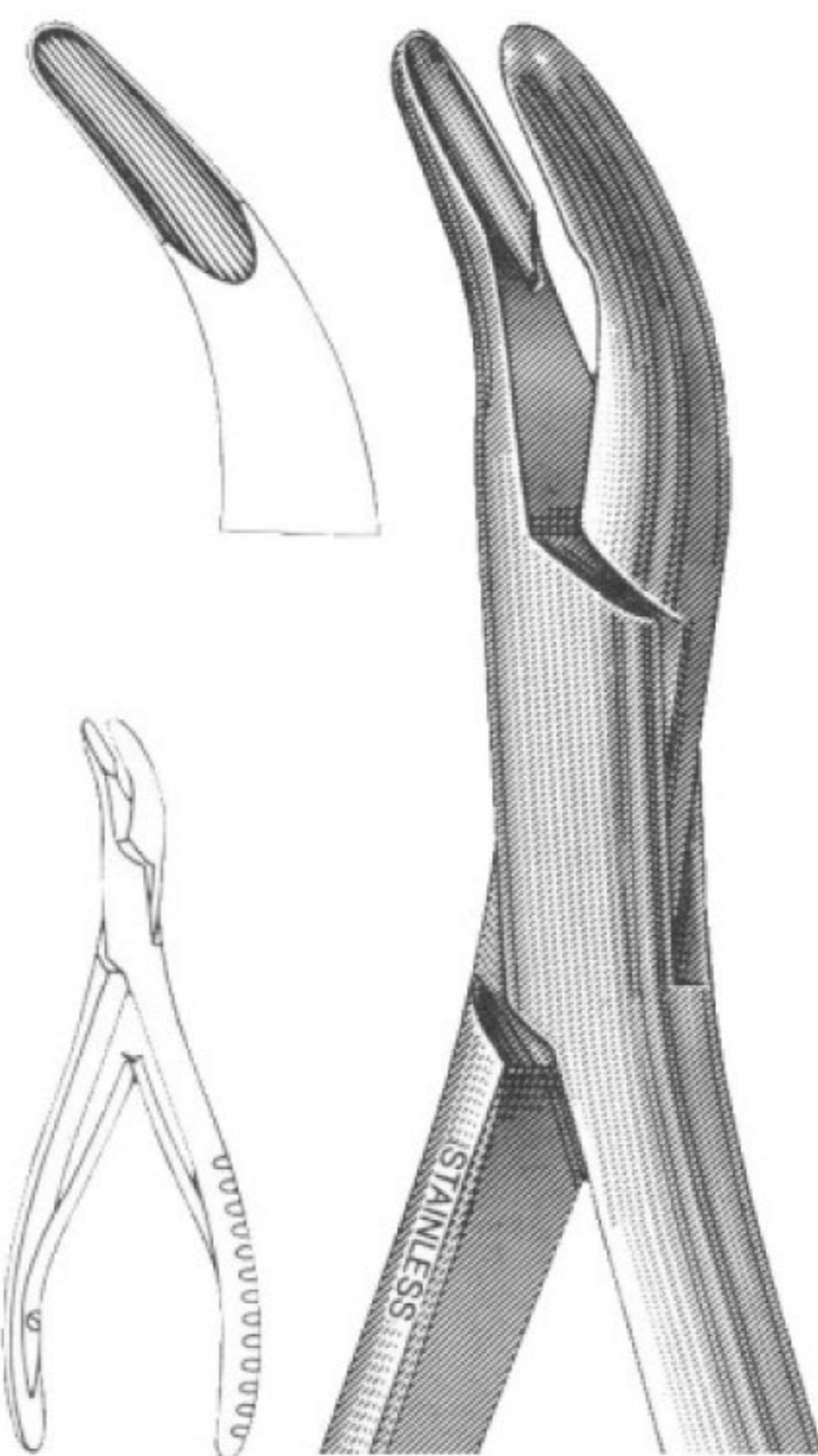

BEYER Double Action, 16,18 cm
MWD-2566
 BEYER Double Action, 16,18 cm



No. 1 6 1/2"
MWD-2567
 No. 1 6 1/2"

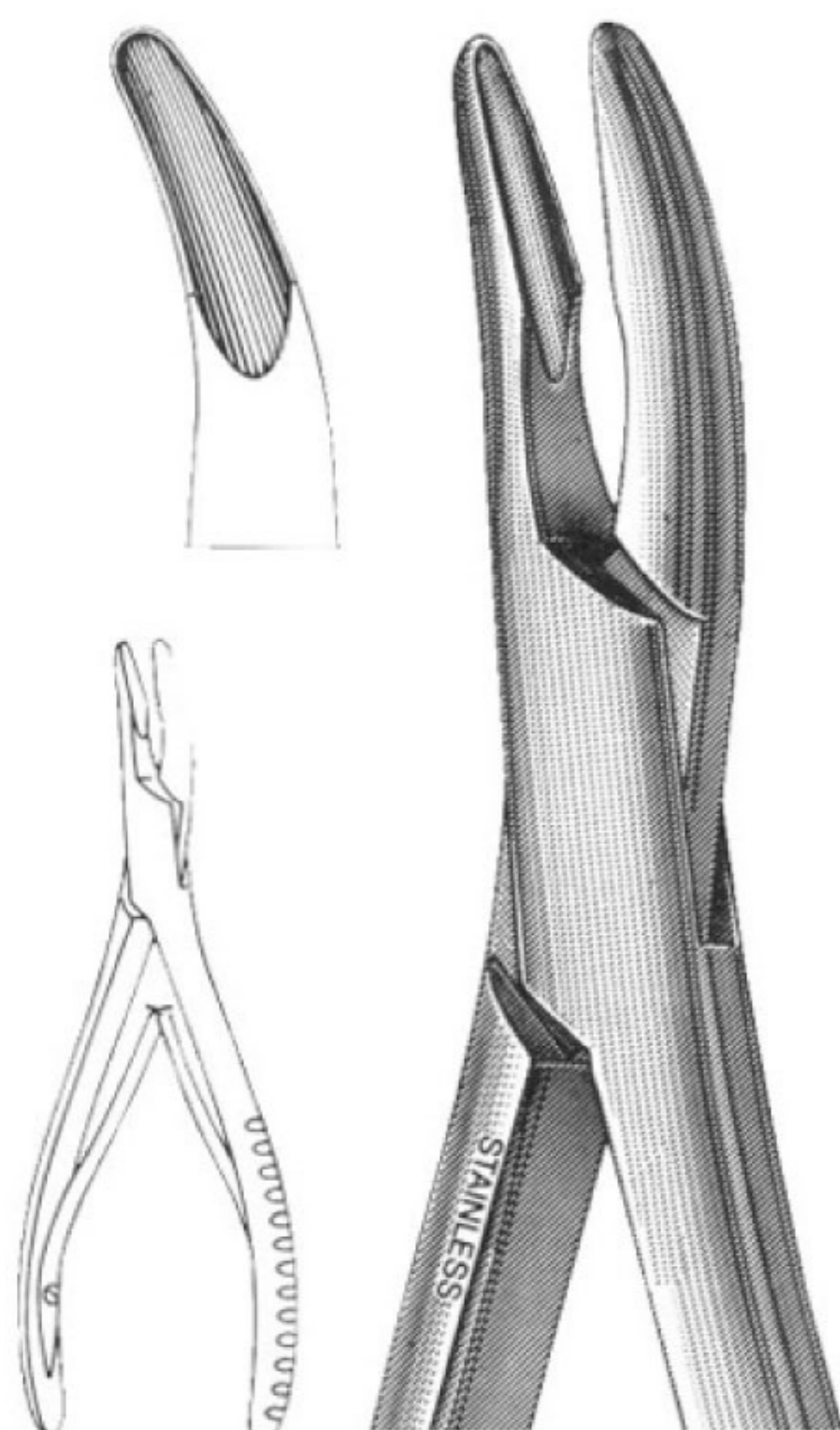

HARTMAN 5 3/4" Strong Curve
MWD-2568
 HARTMAN 5 3/4" Strong Curve



BANE Slight Curve 7"
MWD-2569
 BANE Slight Curve 7"



COLLIER 5", Fenestrated Jaws
MWD-2570
 COLLIER 5", Fenestrated Jaws



DERF 4 3/4"
MWD-2571
 DERF 4 3/4"

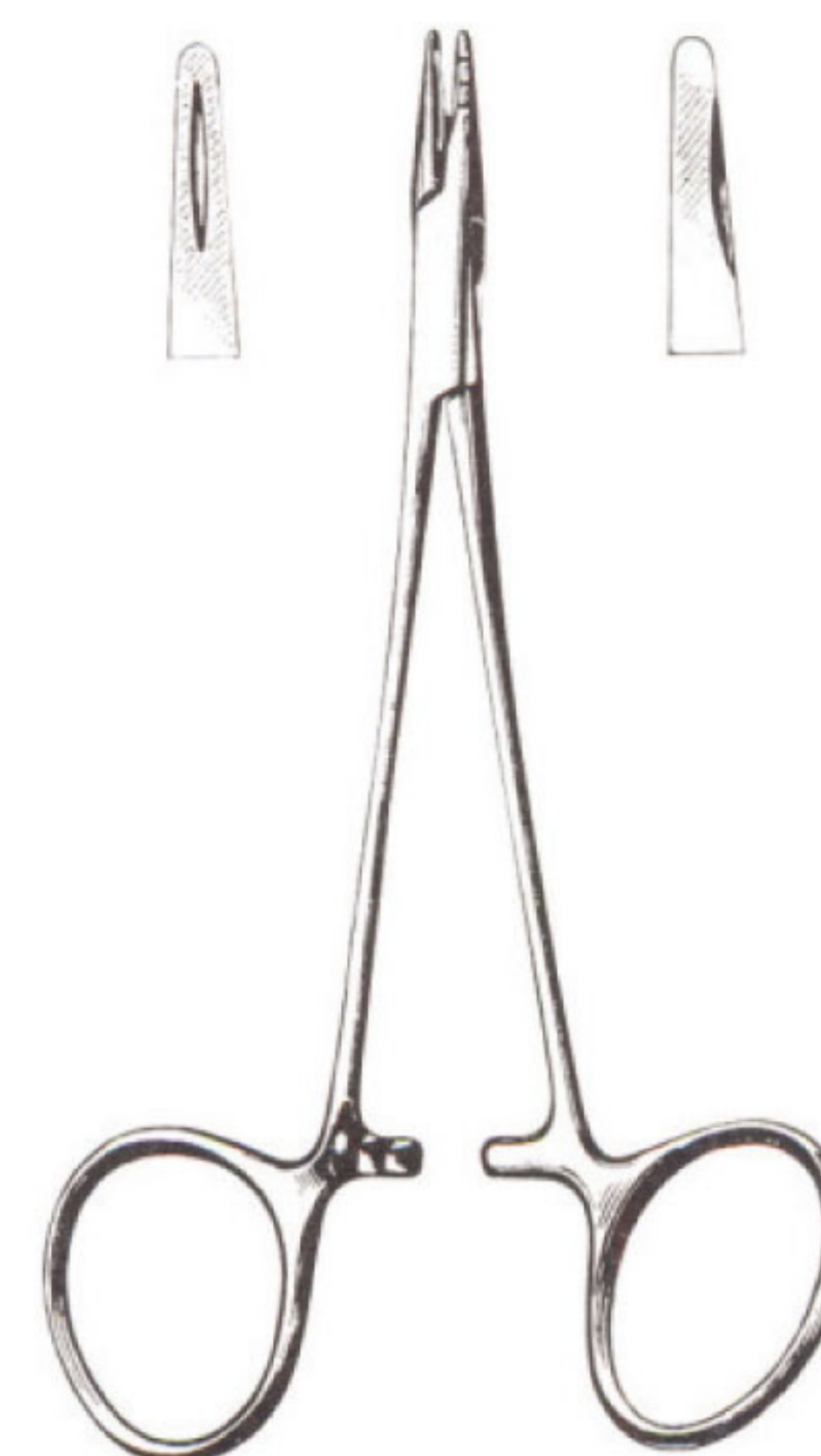

WEBSTER Delicate Smooth Jaws 5"
MWD-2572
 WEBSTER Delicate Smooth Jaws 5"



NEIVERT One Offset Ring 5"
MWD-2573
 NEIVERT One Offset Ring 5"



OLSEN-HEGAR 5 1/2"
MWD-2574
 OLSEN-HEGAR 5 1/2"



BAUMGARTNER 5 1/2"
MWD-2575
 BAUMGARTNER 5 1/2"



CRILE-WOOD 6"
MWD-2576
 CRILE-WOOD 6"



GARDNER 5"
MWD-2577
 GARDNER 5"



MAYO-HEGAR 5"
MWD-2578
 MAYO-HEGAR 5"



CRILE 6"
MWD-2579
 CRILE 6"



CASTROVIEJO Smooth Jaws 5 1/2"
MWD-2580
 CASTROVIEJO Smooth Jaws 5 1/2"



BOYNTON 5"
MWD-2581
 BOYNTON 5"



MATHIEU 5 1/2"
MWD-2582
 MATHIEU 5 1/2"



STEVENS 6 1/2"
MWD-2583
 STEVENS 6 1/2"



Micro Scissor Straight, 155 mm
MWD-2584
 Micro Scissor Straight, 155 mm



Micro Scissor Straight, 150 mm
MWD-2585
 Micro Scissor Straight, 150 mm



Micro Scissor Curved, 150 mm
MWD-2586
 Micro Scissor Curved, 150 mm



Micro Scissor Curved, 155 mm
MWD-2587
 Micro Scissor Curved, 155 mm



CASTROVIEJO T.C. Straight, 180 mm
MWD-2588
 CASTROVIEJO T.C. Straight, 180 mm

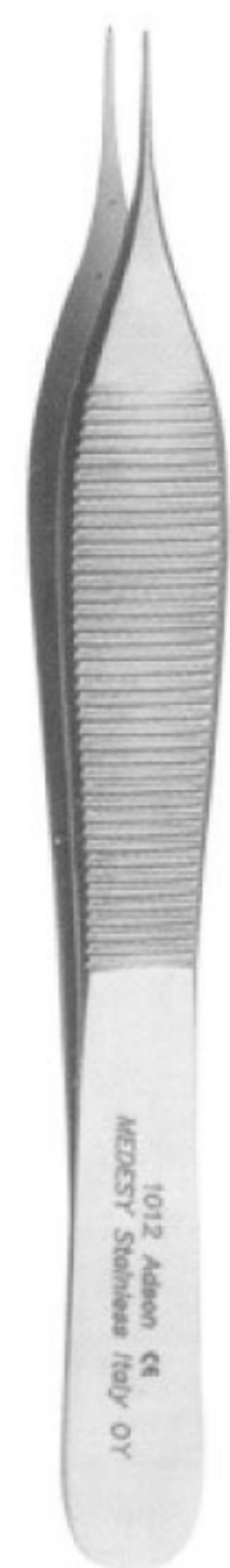

Retractor Fig.3 165 mm
MWD-2589
 Retractor Fig.3 165 mm



Micro Adson 120 mm
MWD-2590
 Micro Adson 120 mm



GERALD Curved, 180 mm
MWD-2591
 GERALD Curved, 180 mm



GERALD Straight, 175 mm
MWD-2592
 GERALD Straight, 175 mm



Micro Adson 160 mm
MWD-2593
 Micro Adson 160 mm

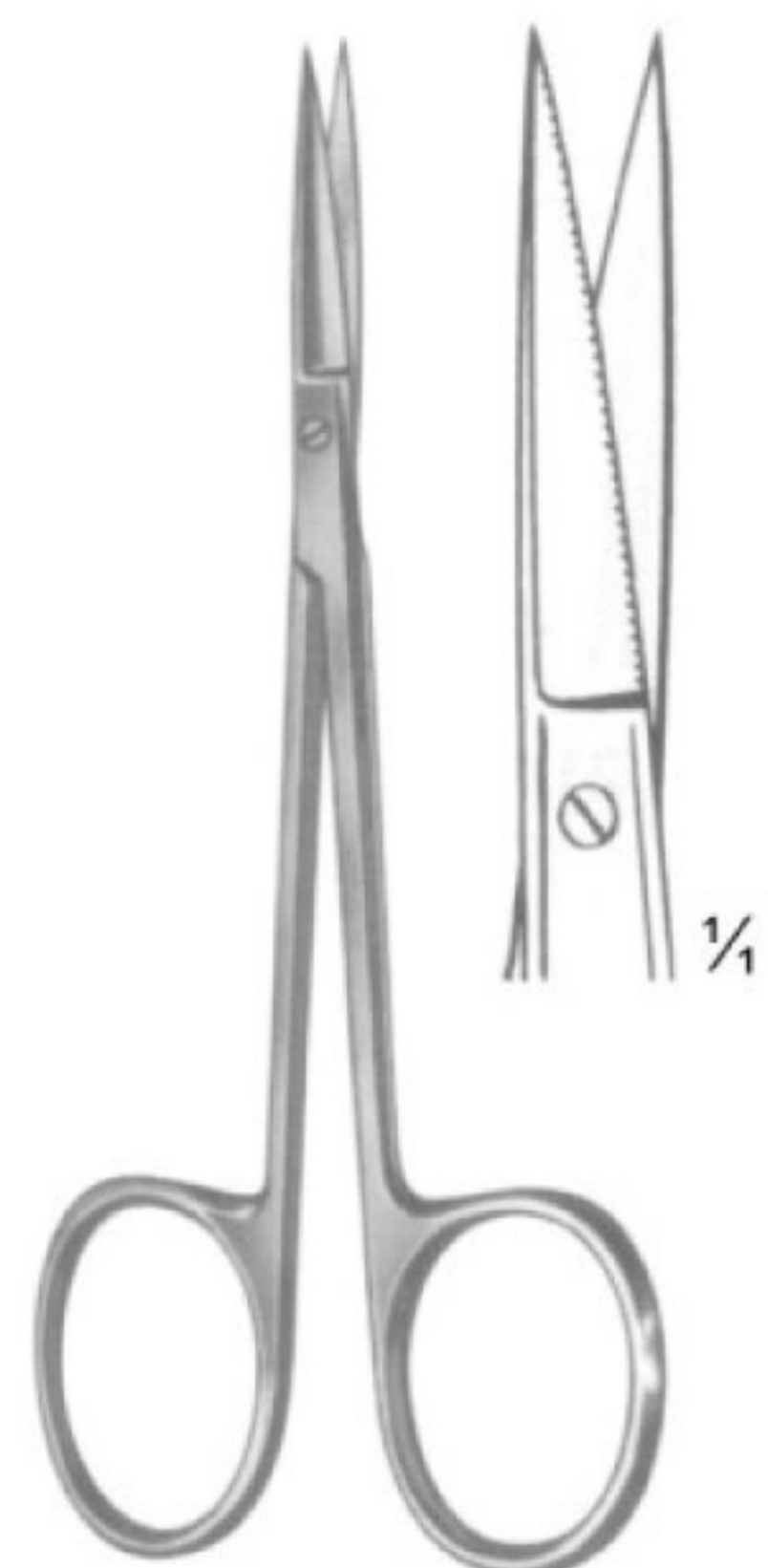

Micro Surgery Set 10 Pieces.
MWD-2594
 Micro Surgery Set 10 Pieces.

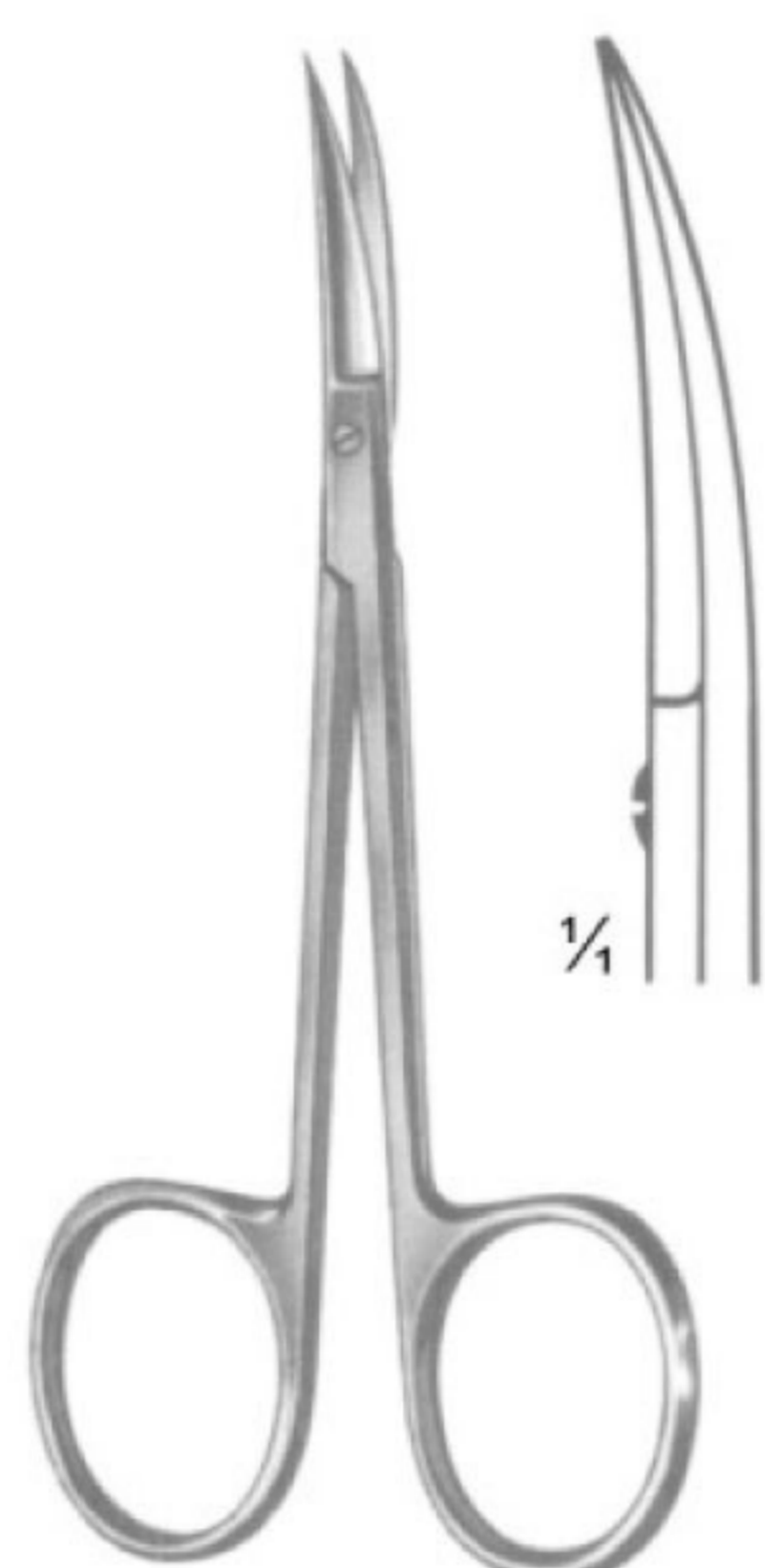

IRIS (Standard) Straight 11.5 cm, 4 1/2"
MWD-2595
 IRIS (Standard) Straight 11.5 cm, 4 1/2"



IRIS (Standard) Curved 11.5 cm, 4 1/2"
MWD-2596
 IRIS (Standard) Curved 11.5 cm, 4 1/2"

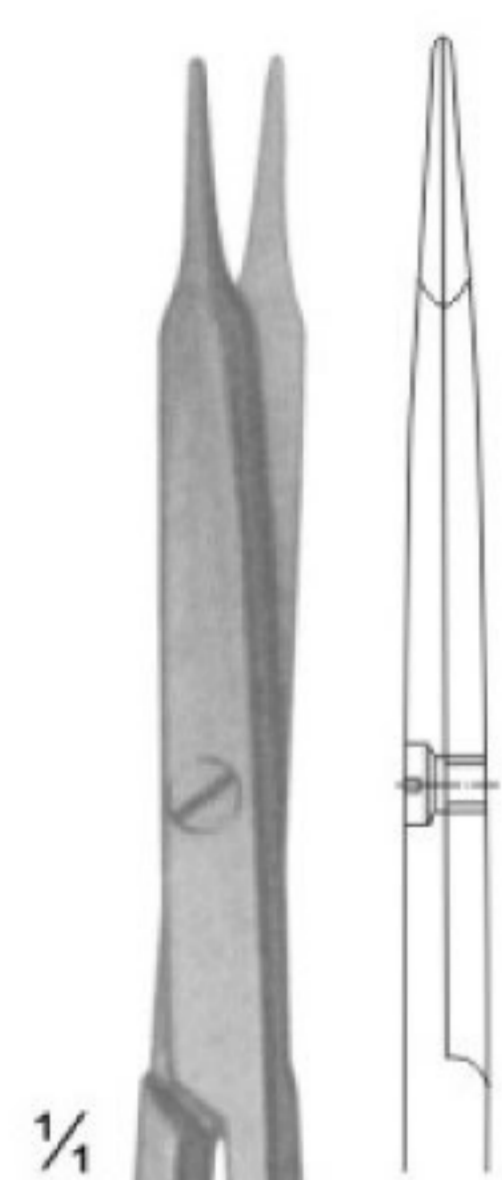

STEVENS Dissecting Scissors Size: 115 mm
MWD-2597
 STEVENS Dissecting Scissors Size: 115 mm

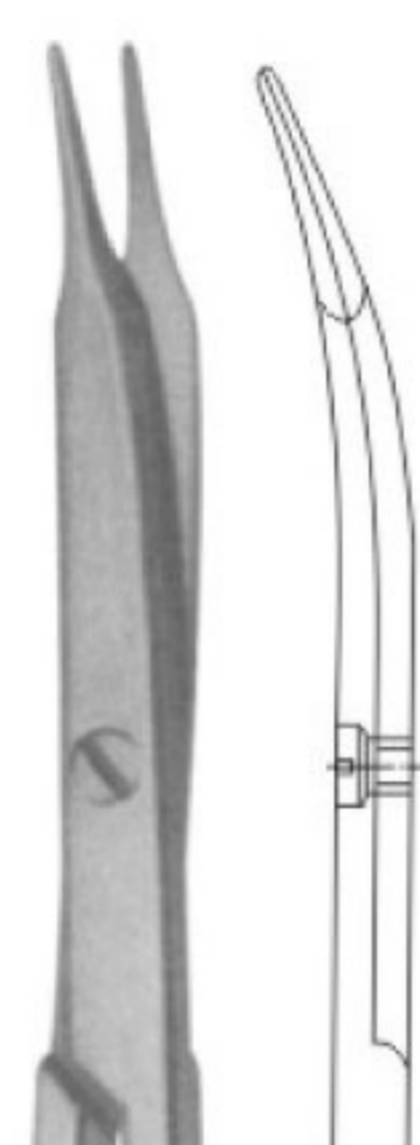

Sharp
MWD-2598
 Sharp

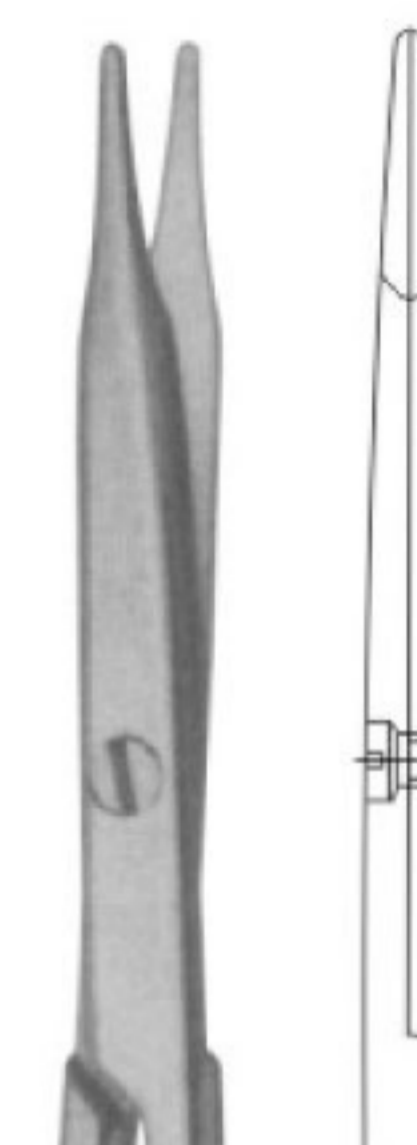

Sharp
MWD-2599
 Sharp

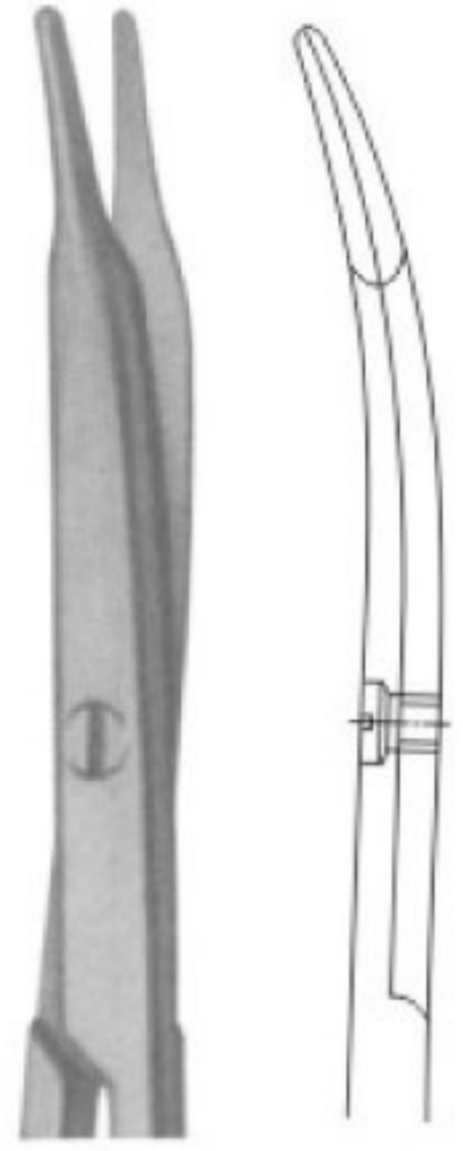

Blunt
MWD-2600
Blunt

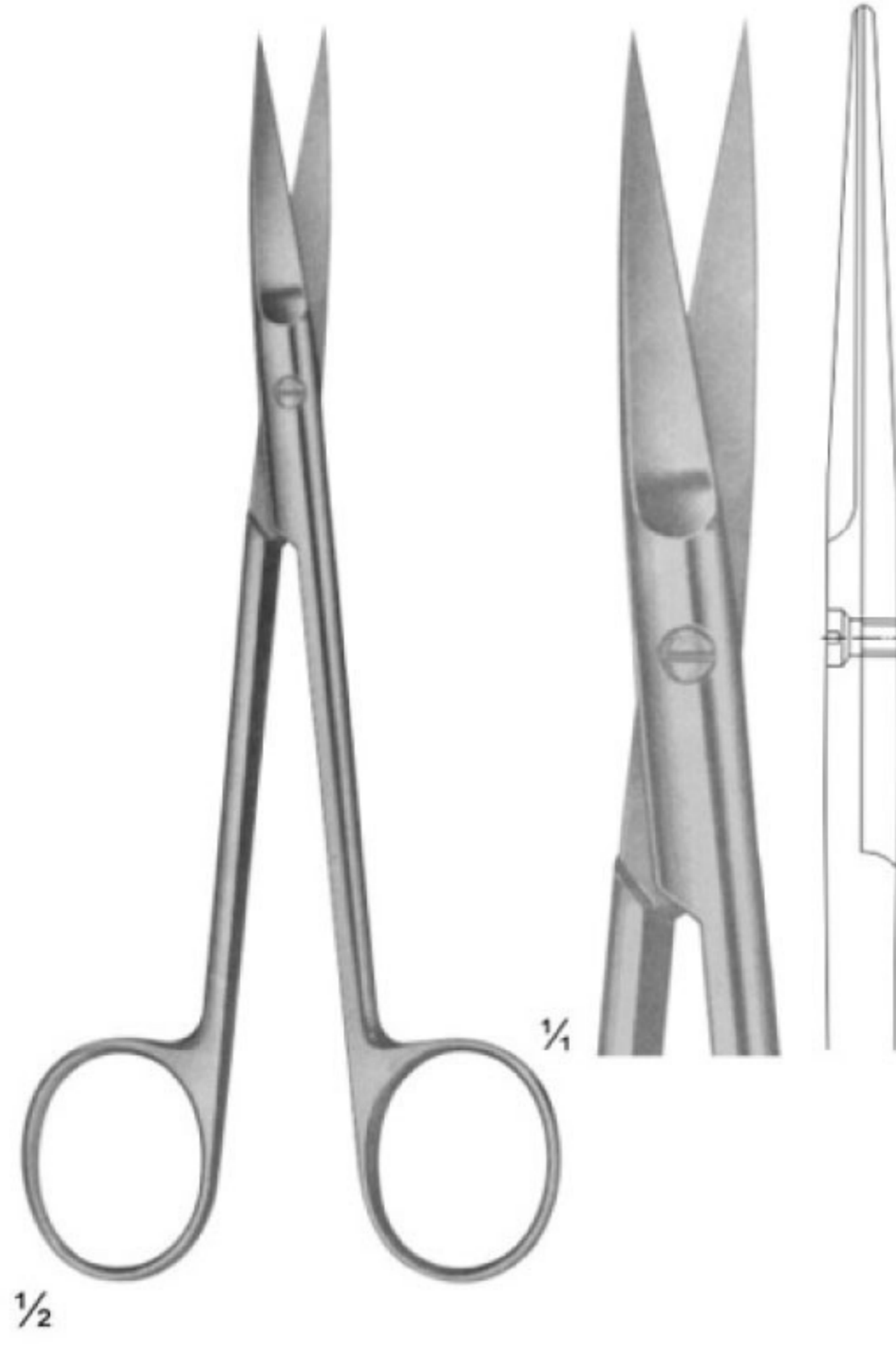

Blunt
MWD-2601
Blunt

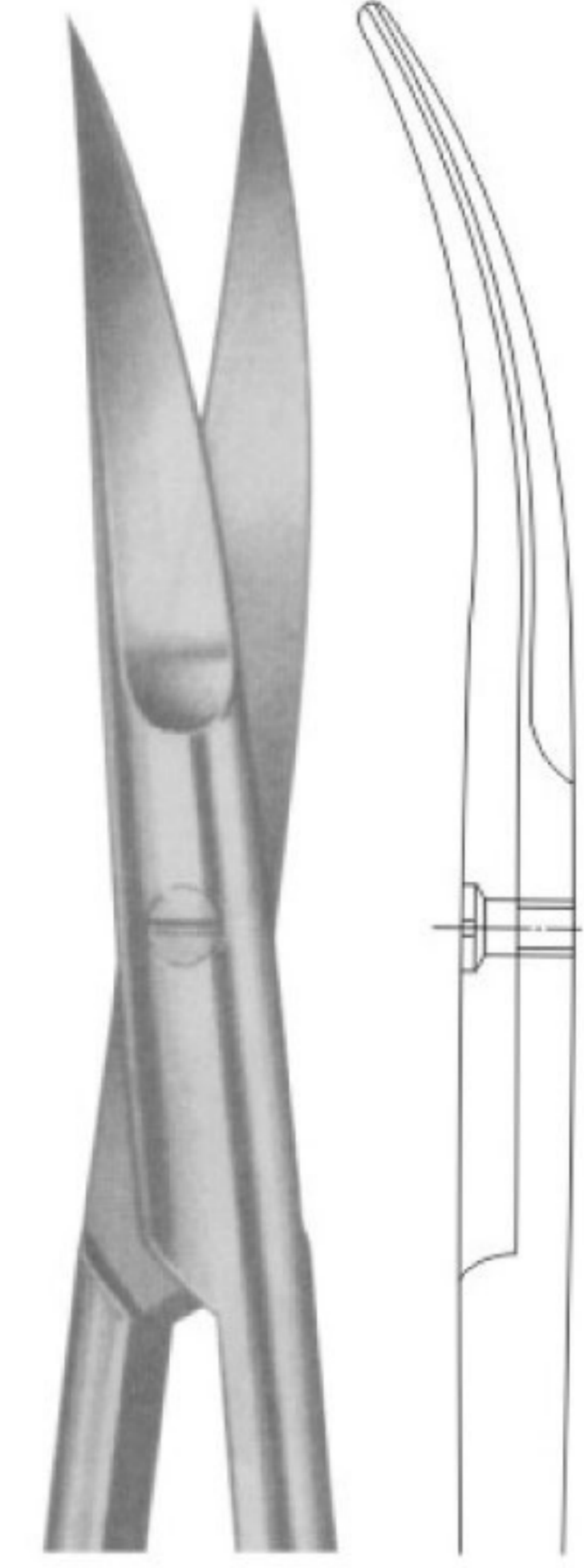

MWD-2602

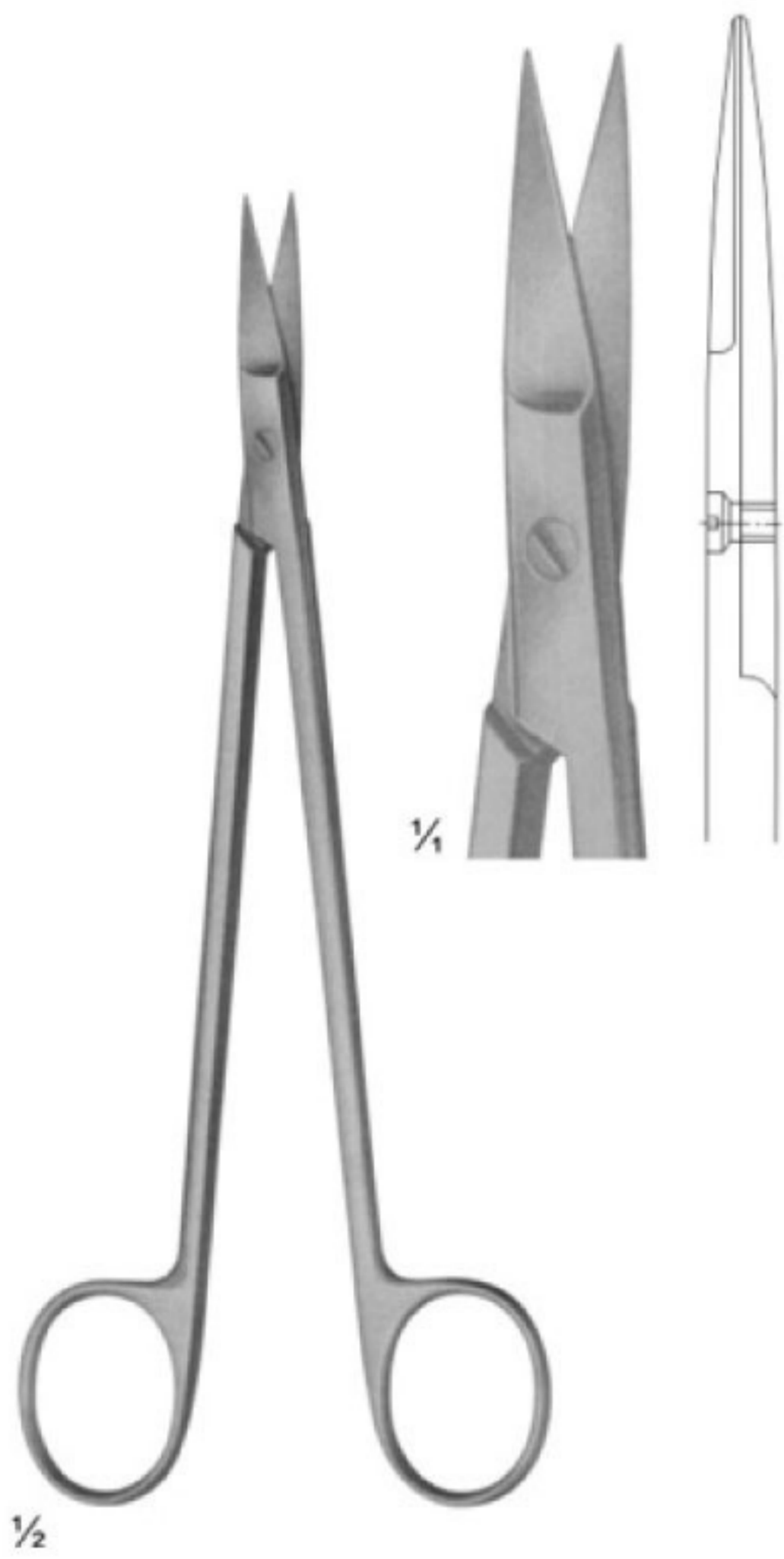

MWD-2603

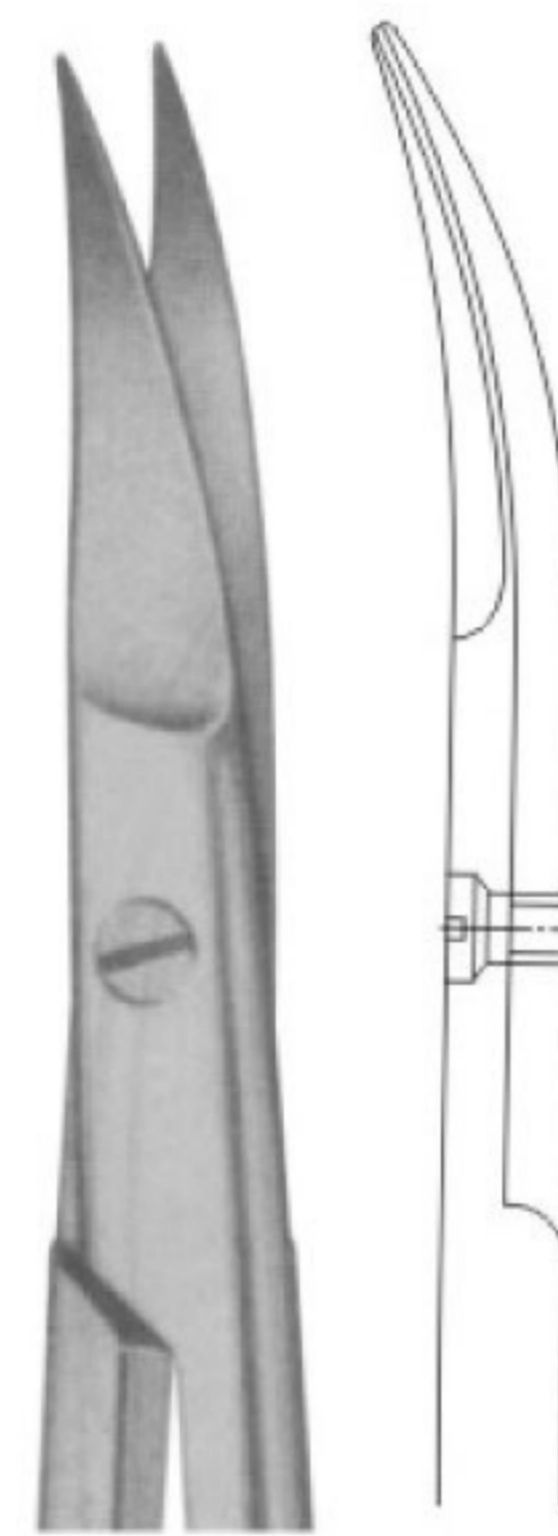

KELLY Size: 175 mm
MWD-2604
KELLY Size: 175 mm

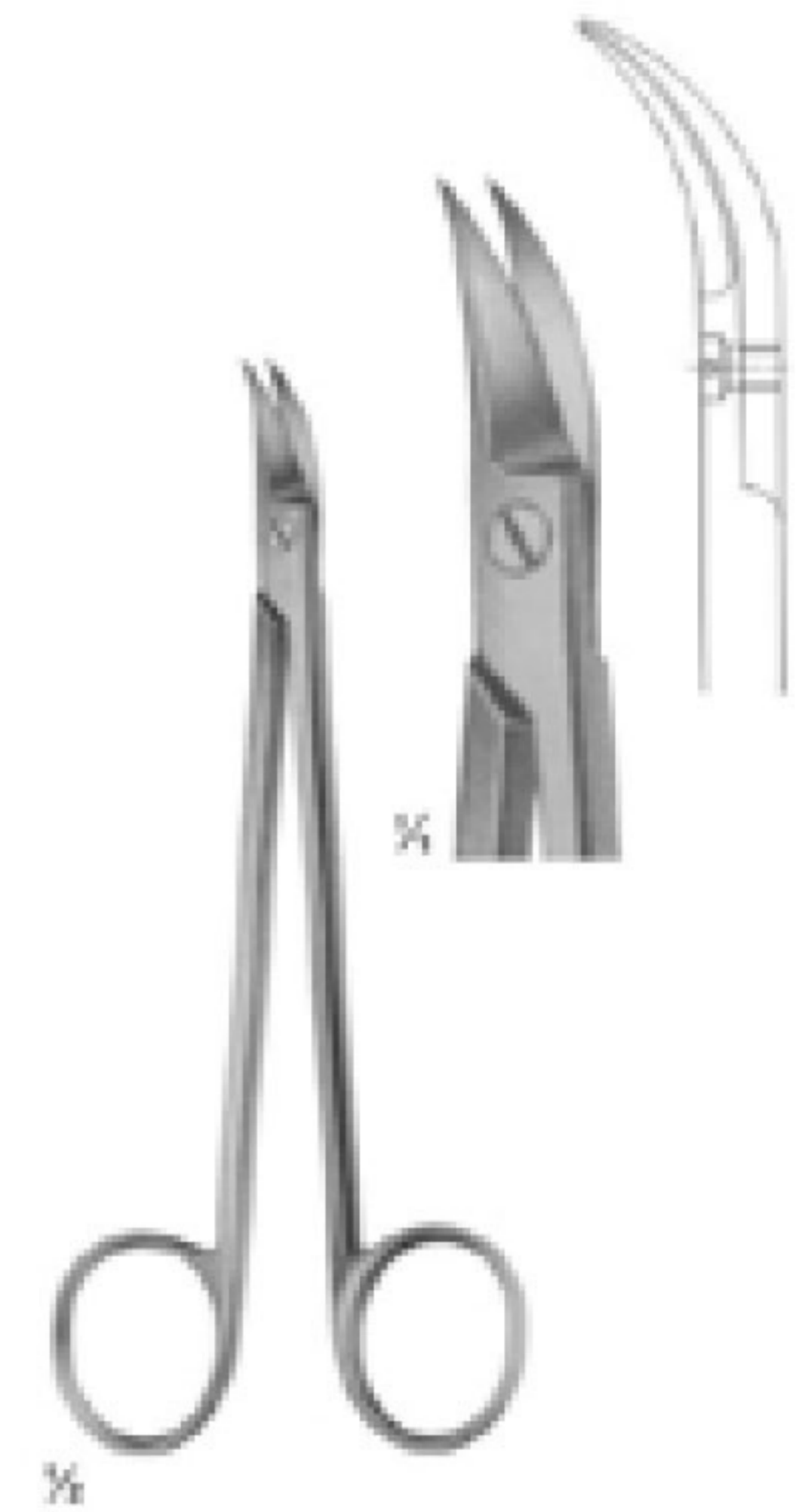

MWD-2605



1/2

MWD-2606



1/2

QUINBY Size: 130 mm

MWD-2607

QUINBY Size: 130 mm



1/4

Standard - Types Size: 115 mm

MWD-2608

Standard - Types Size: 115 mm

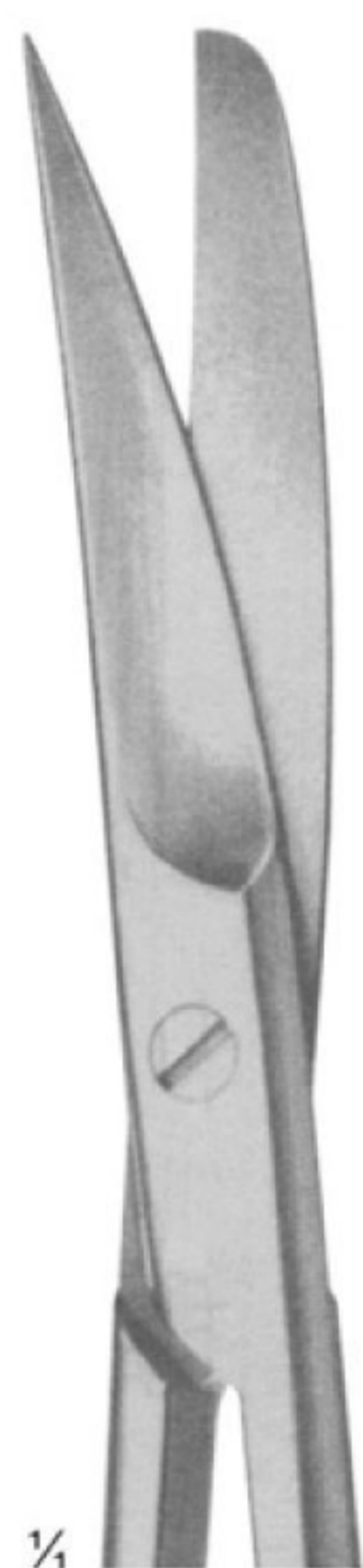

1/4

DEAVER With flat lock

MWD-2609

DEAVER With flat lock

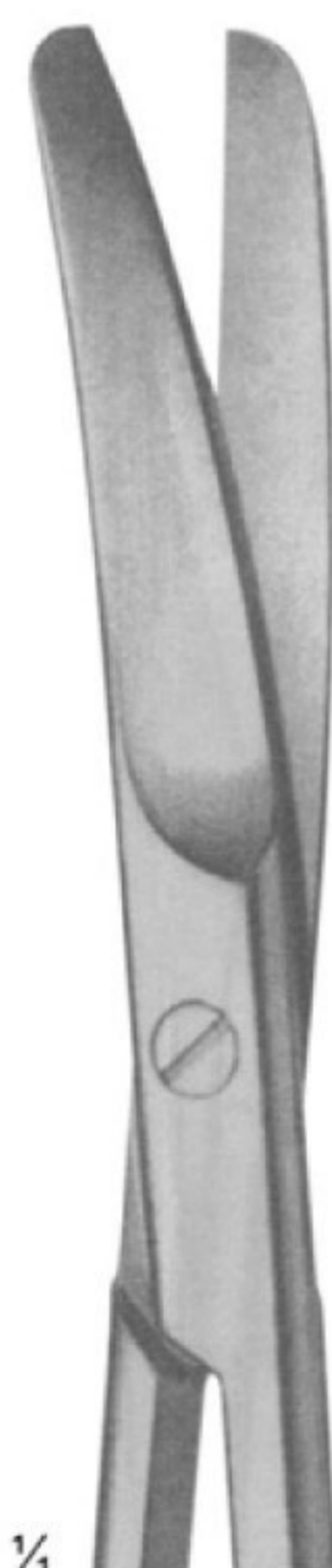

1/4

MWD-2610

Size: 145 mm

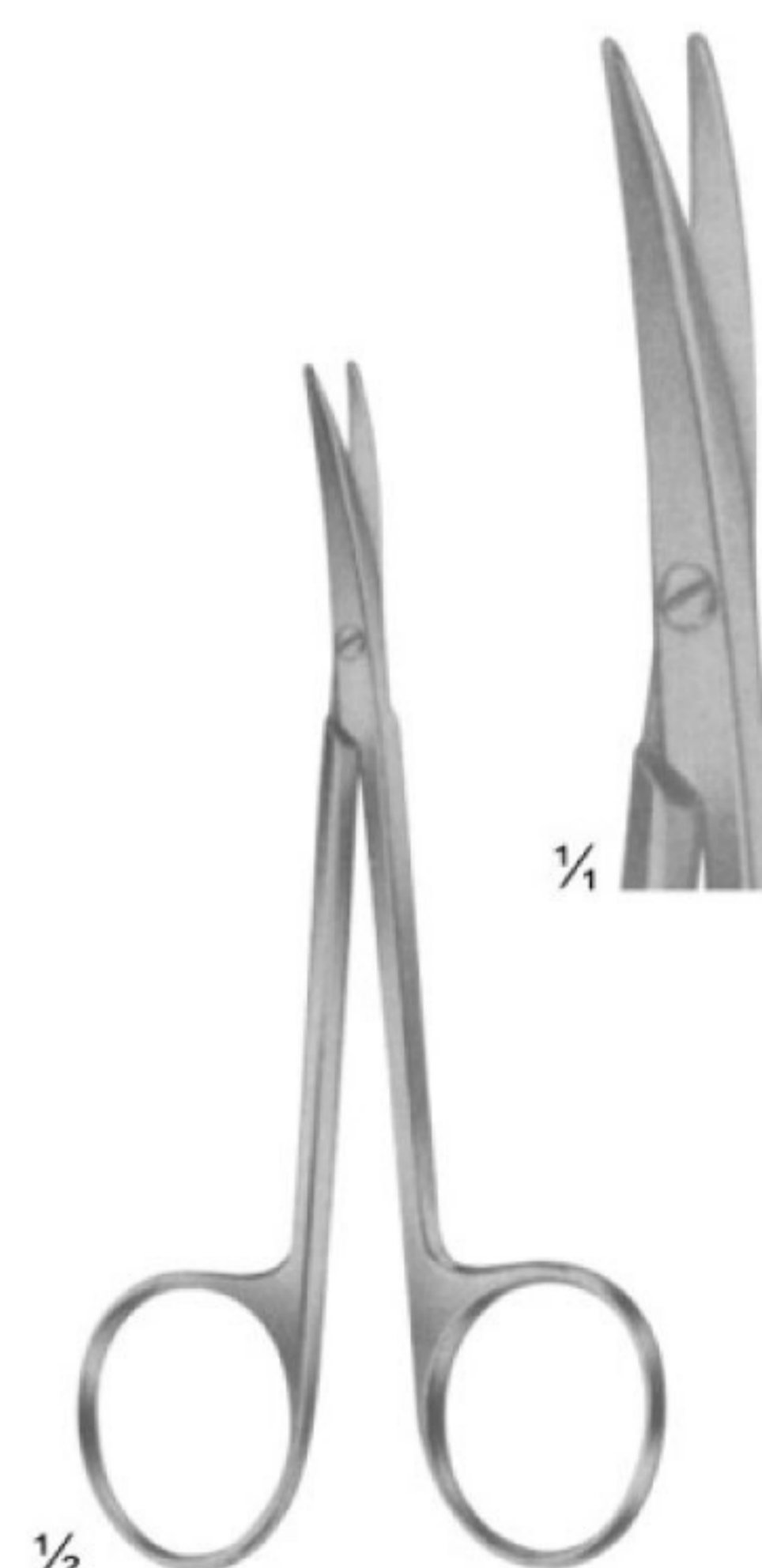

1/2

1/4

MWD-2611

Size: 145 mm

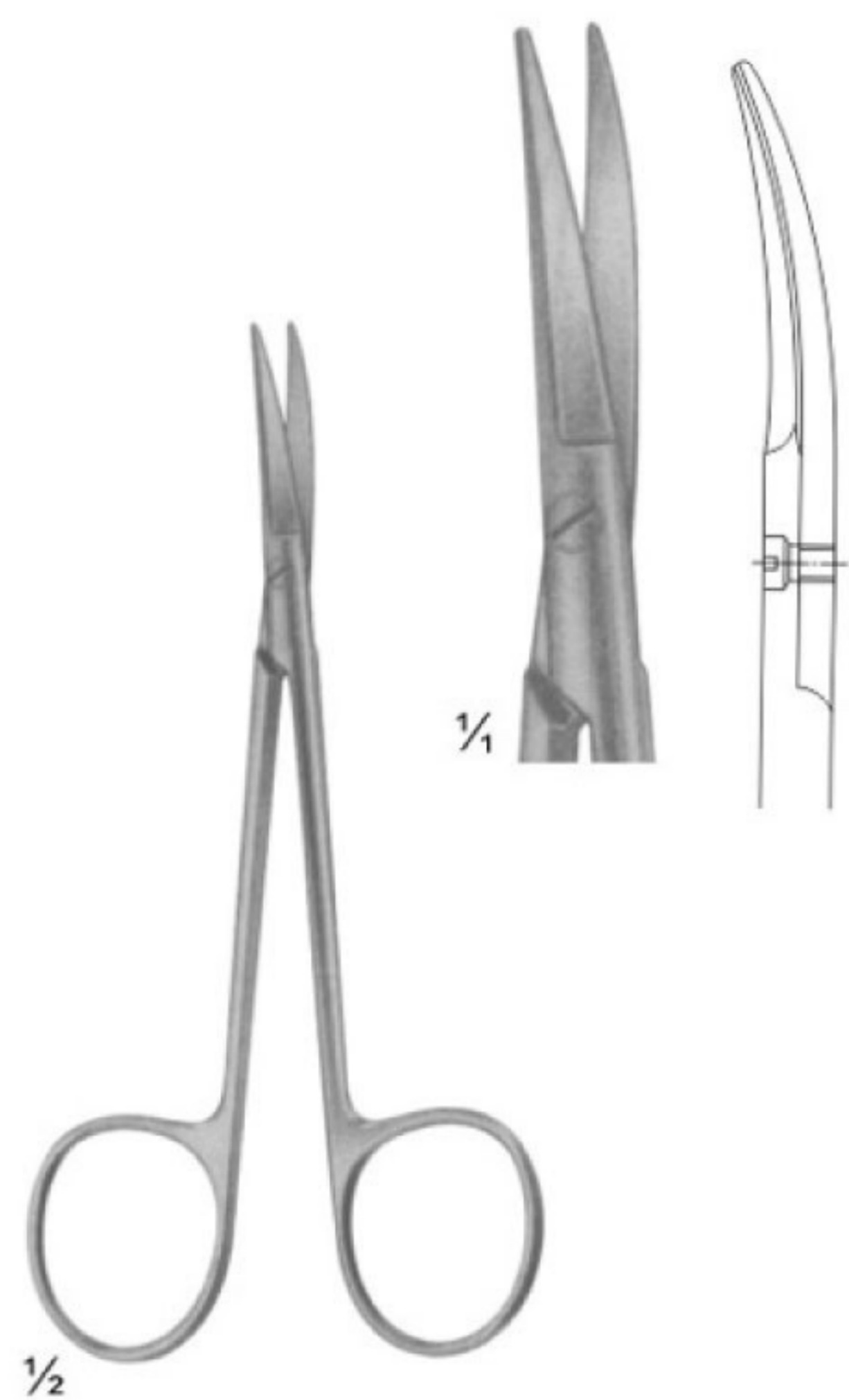

MWD-2612
Size: 145 mm

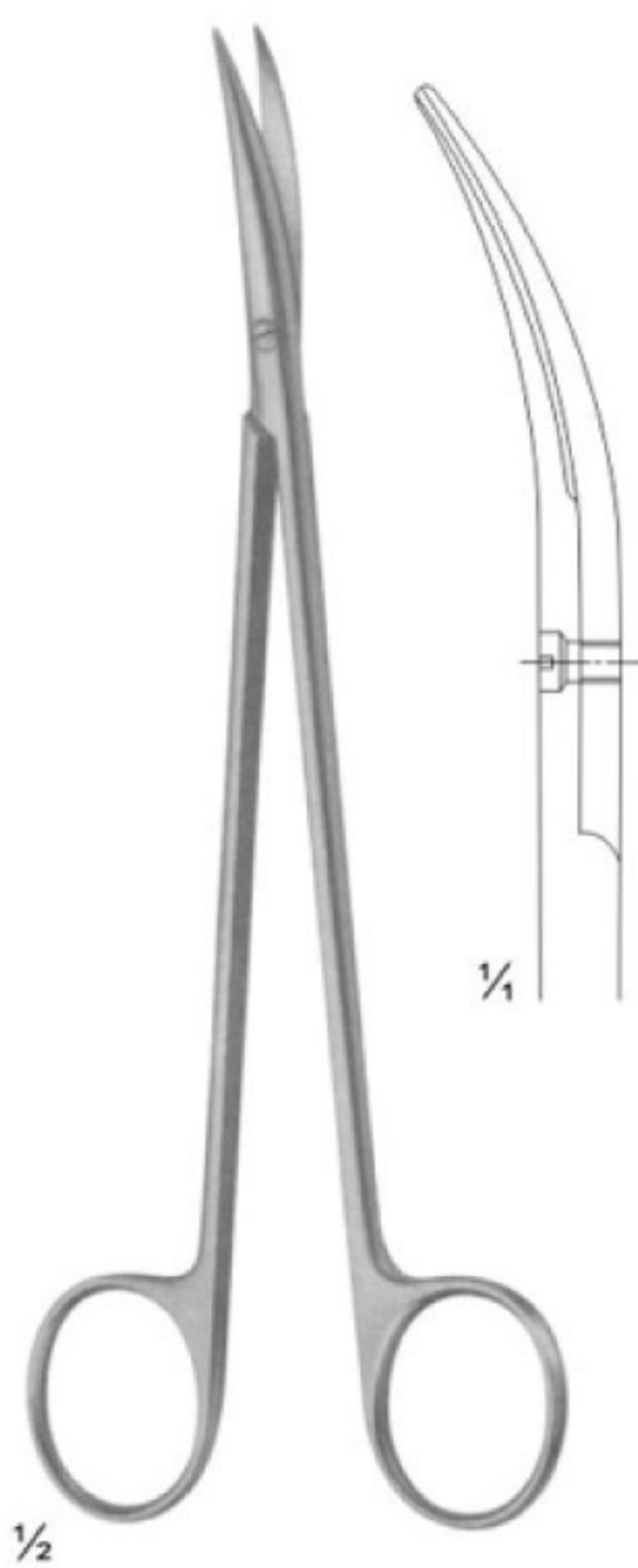

LITTLER Dissecting Scissors Size: 115 mm
MWD-2613
LITTLER Dissecting Scissors Size: 115 mm

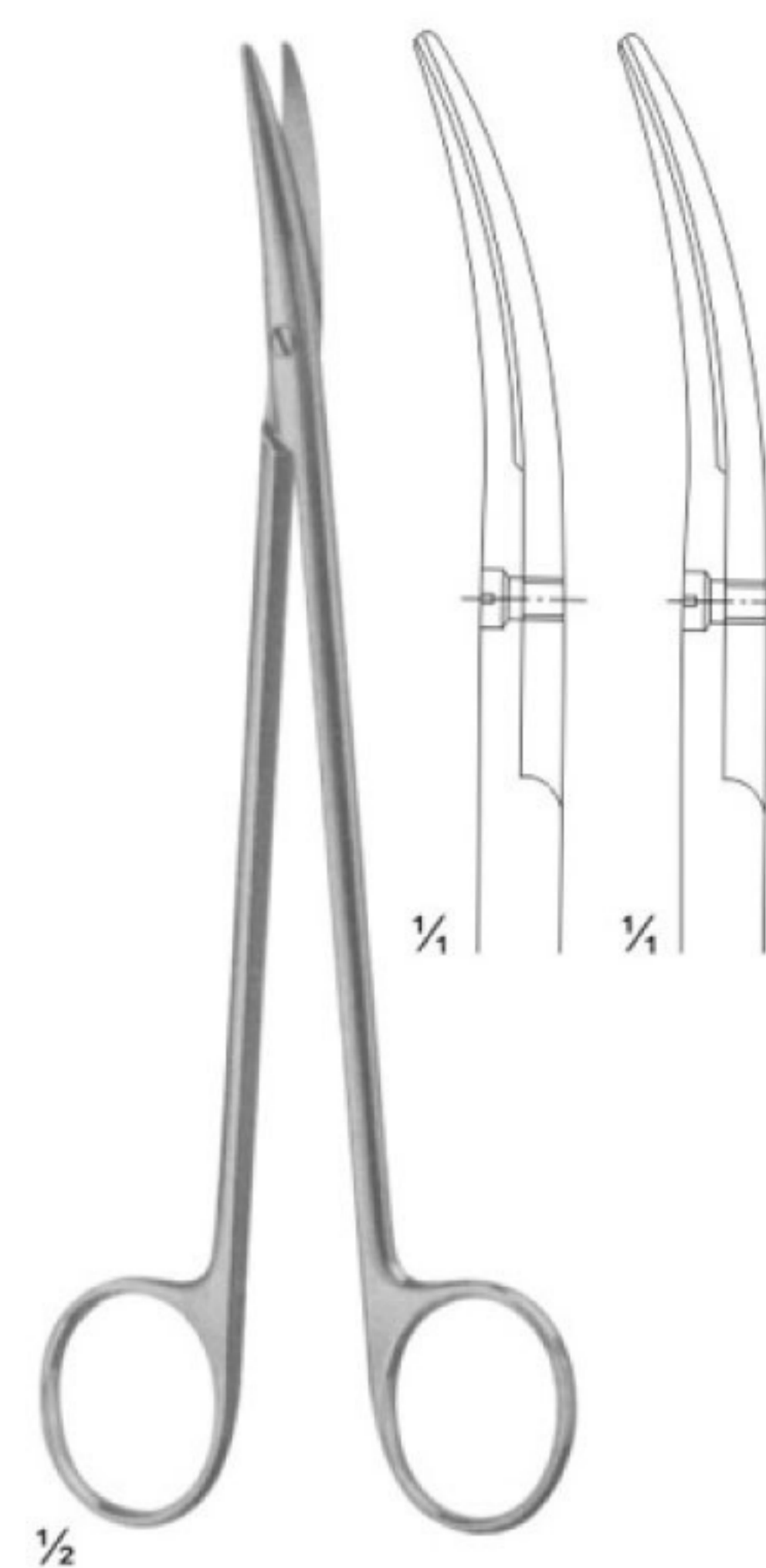

COTTLE Bulldog Scissors Size: 115 mm
MWD-2614
COTTLE Bulldog Scissors Size: 115 mm



DE BAKEY Ateriotomy scissors Size: 175 mm
MWD-2615
DE BAKEY Ateriotomy scissors Size: 175 mm



TOENNIS - ADSON Dissecting scissors
Size: 175 mm
MWD-2616
TOENNIS - ADSON Dissecting scissors
Size: 175 mm

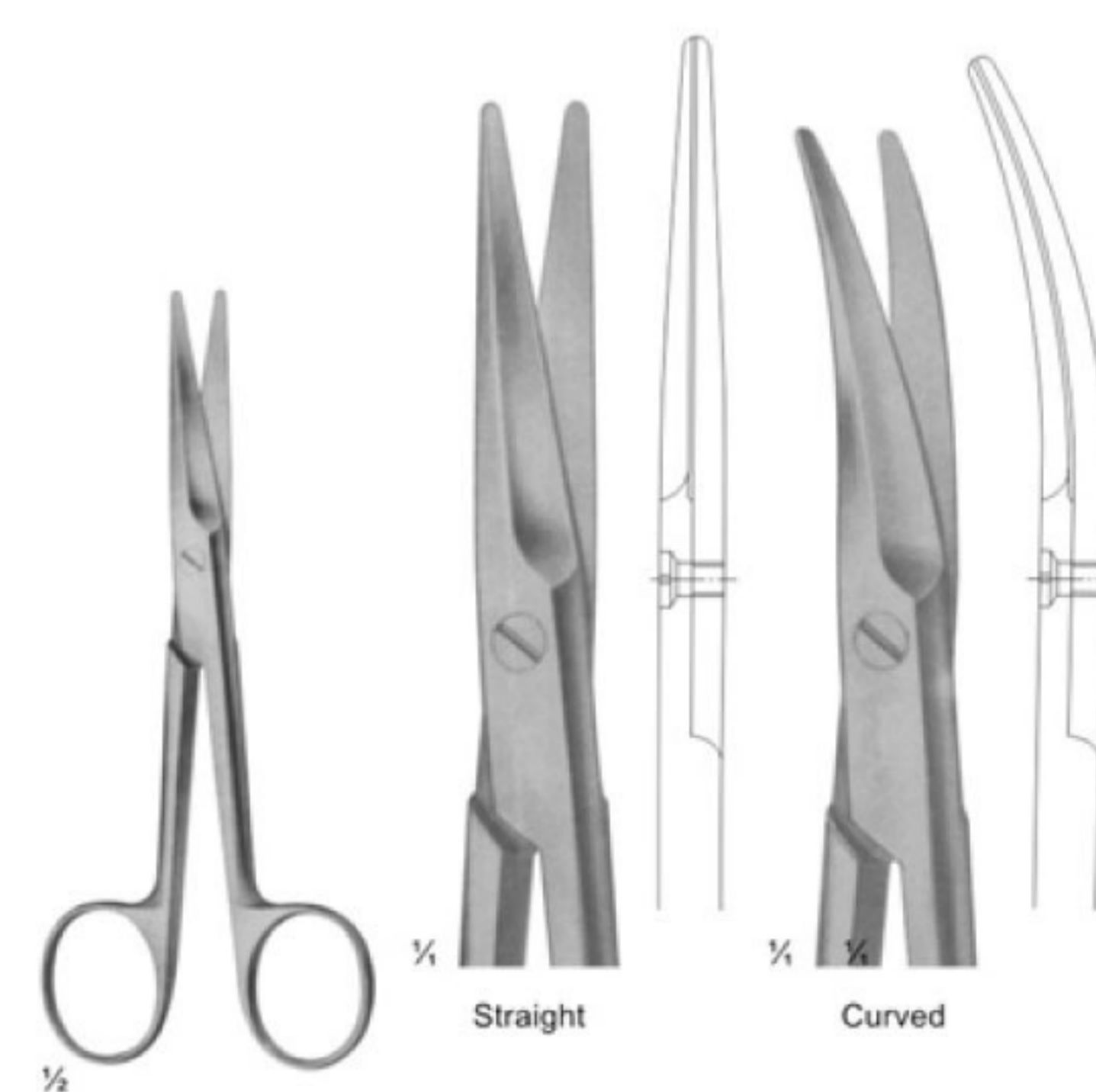

KNOWLES Size: 145 mm
MWD-2617
KNOWLES Size: 145 mm

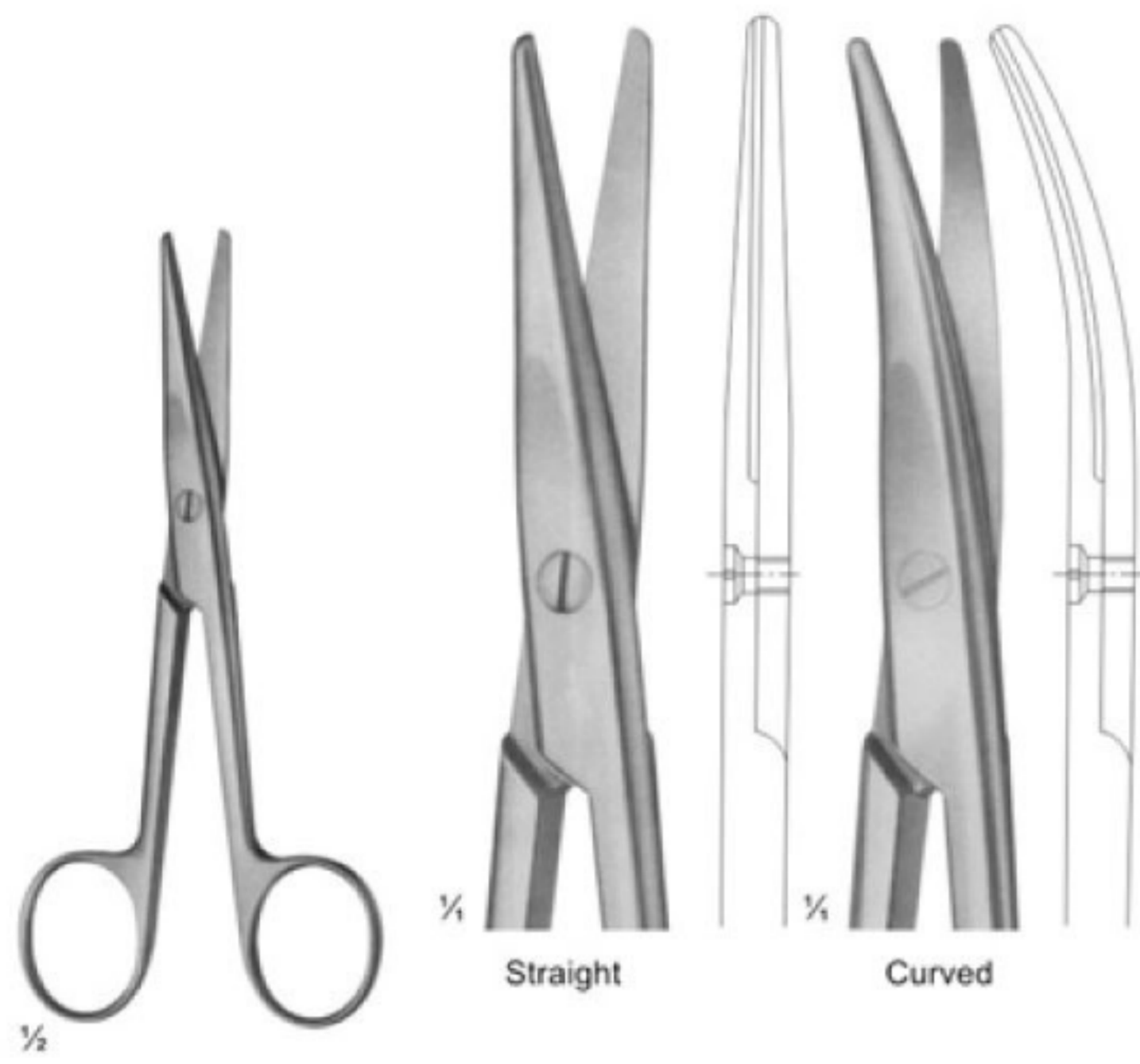

LISTER
MWD-2618
 LISTER IS-2618

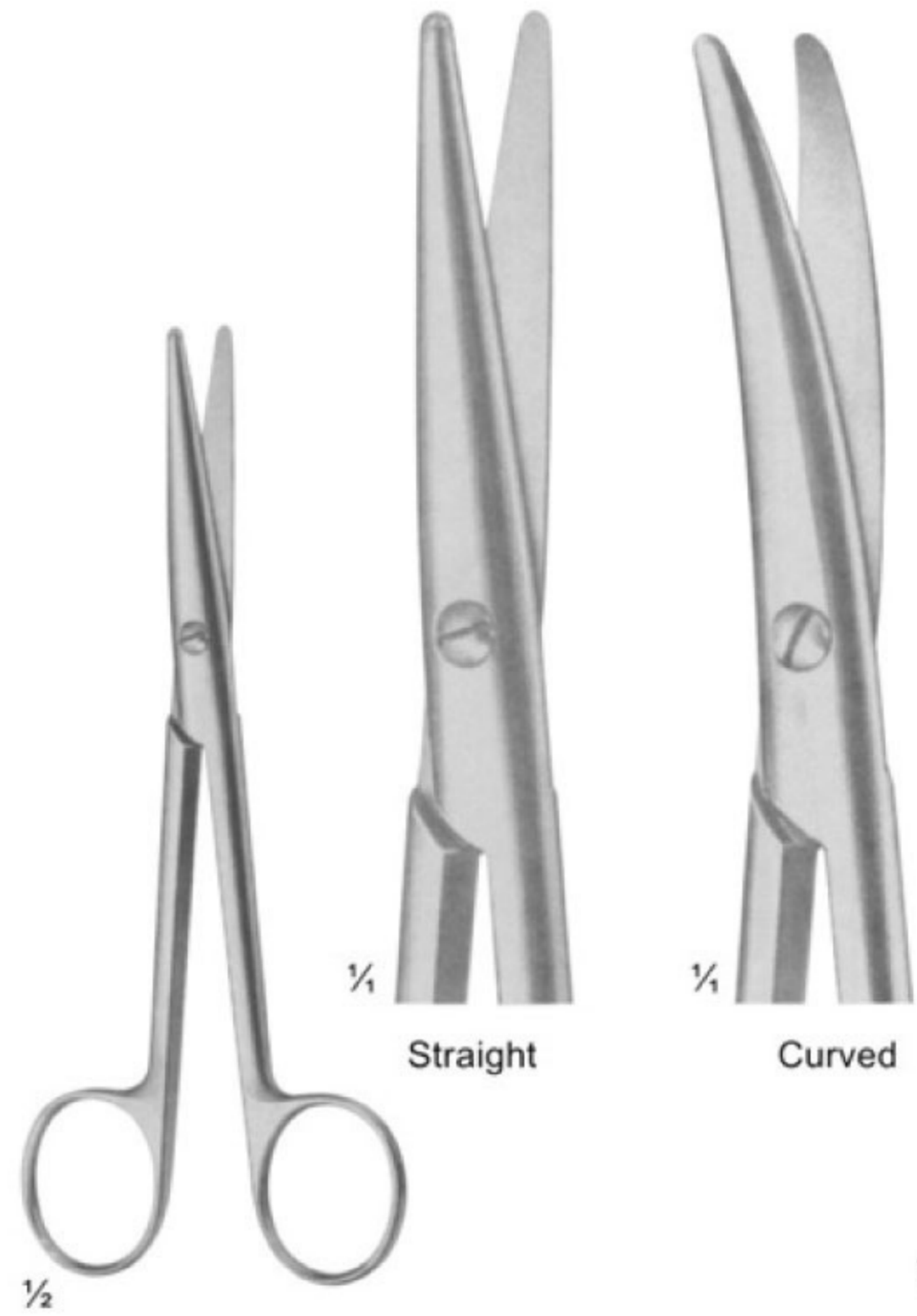

MAYO(straight) Size: 140 mm
MWD-2619
 MAYO(straight) Size: 140 mm

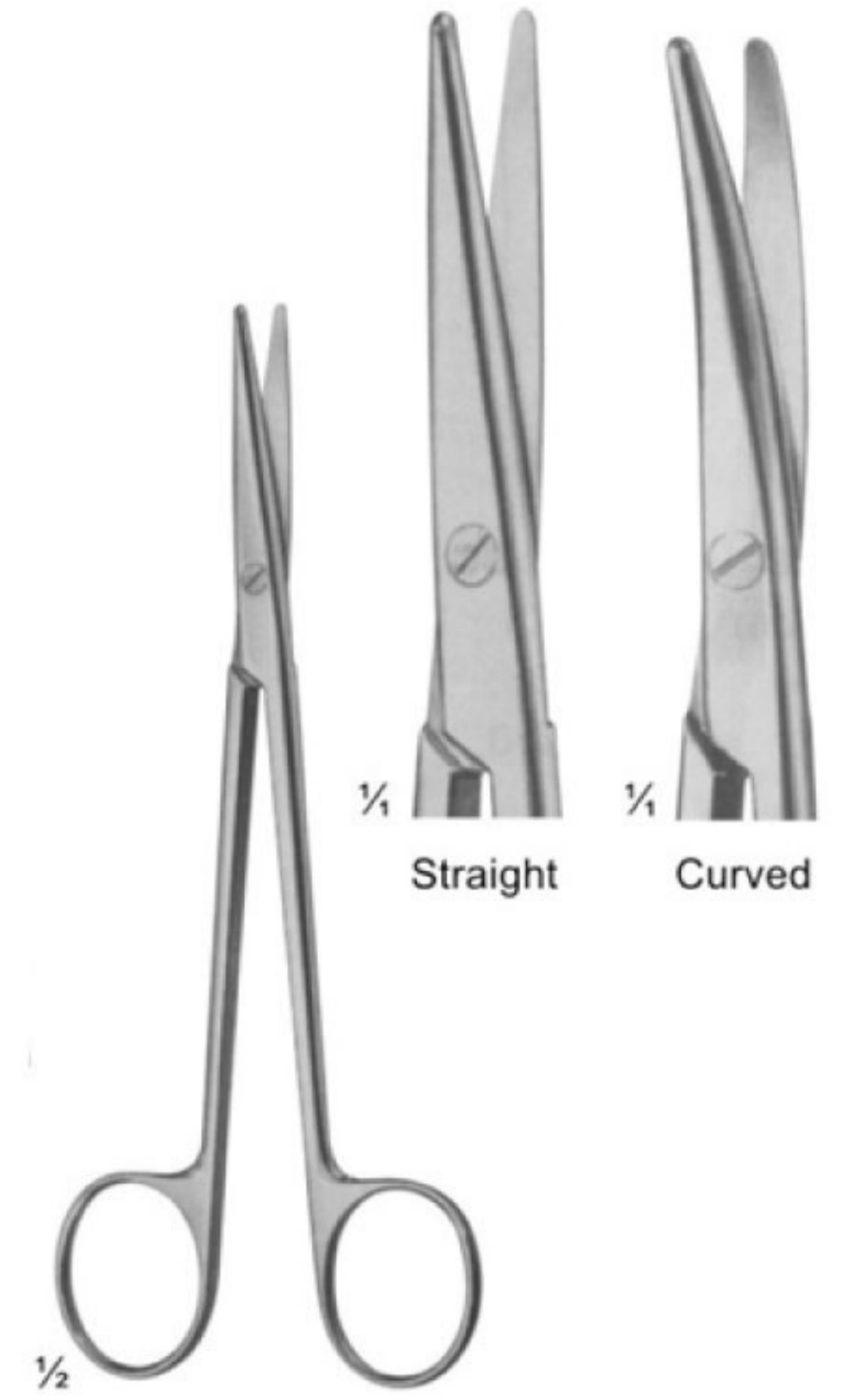

MAYO-STILLE (straight) Size: 140 mm
MWD-2620
 MAYO-STILLE (straight) Size: 140 mm

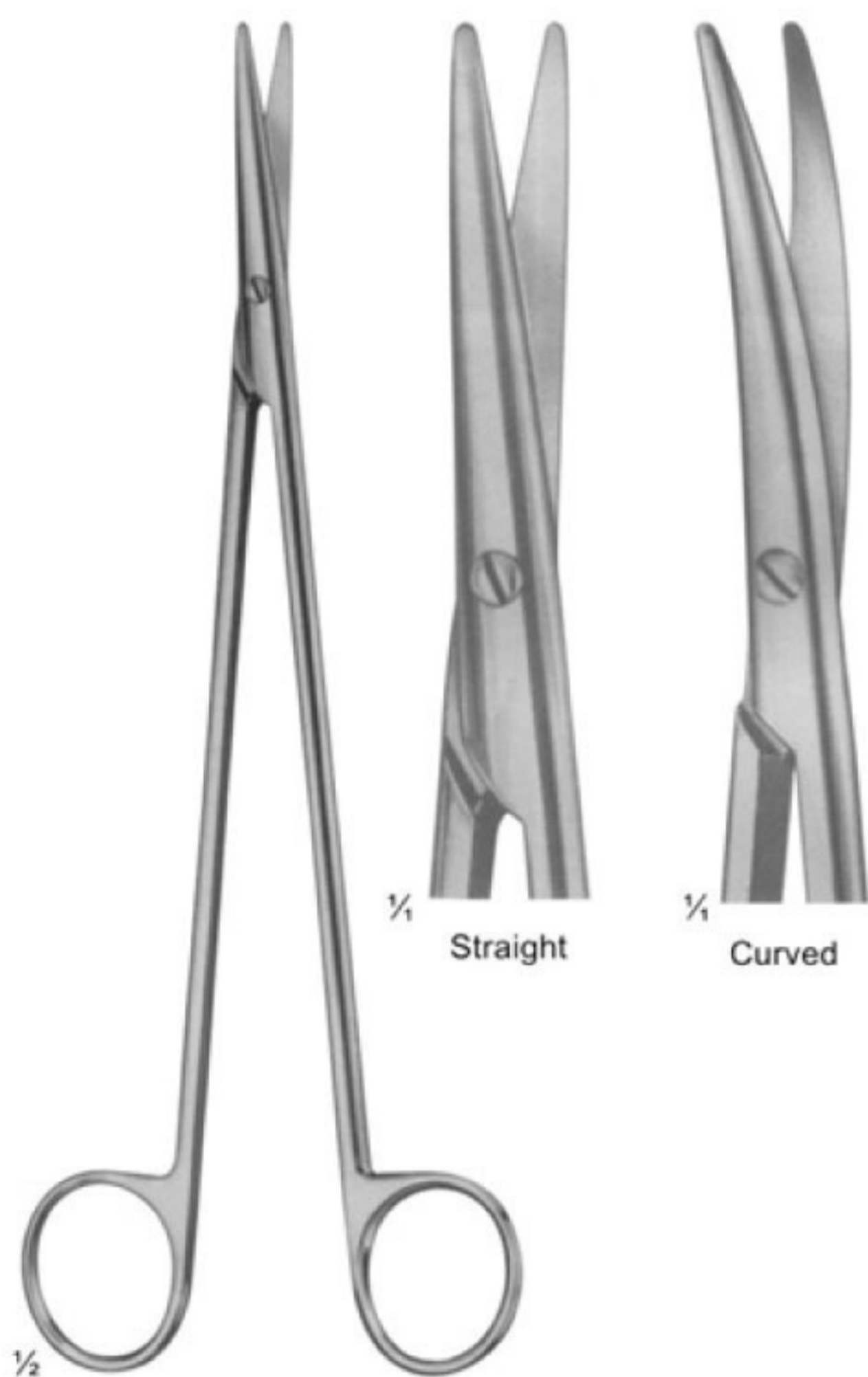

STILLE Size: 140 mm
MWD-2621
 STILLE Size: 140 mm

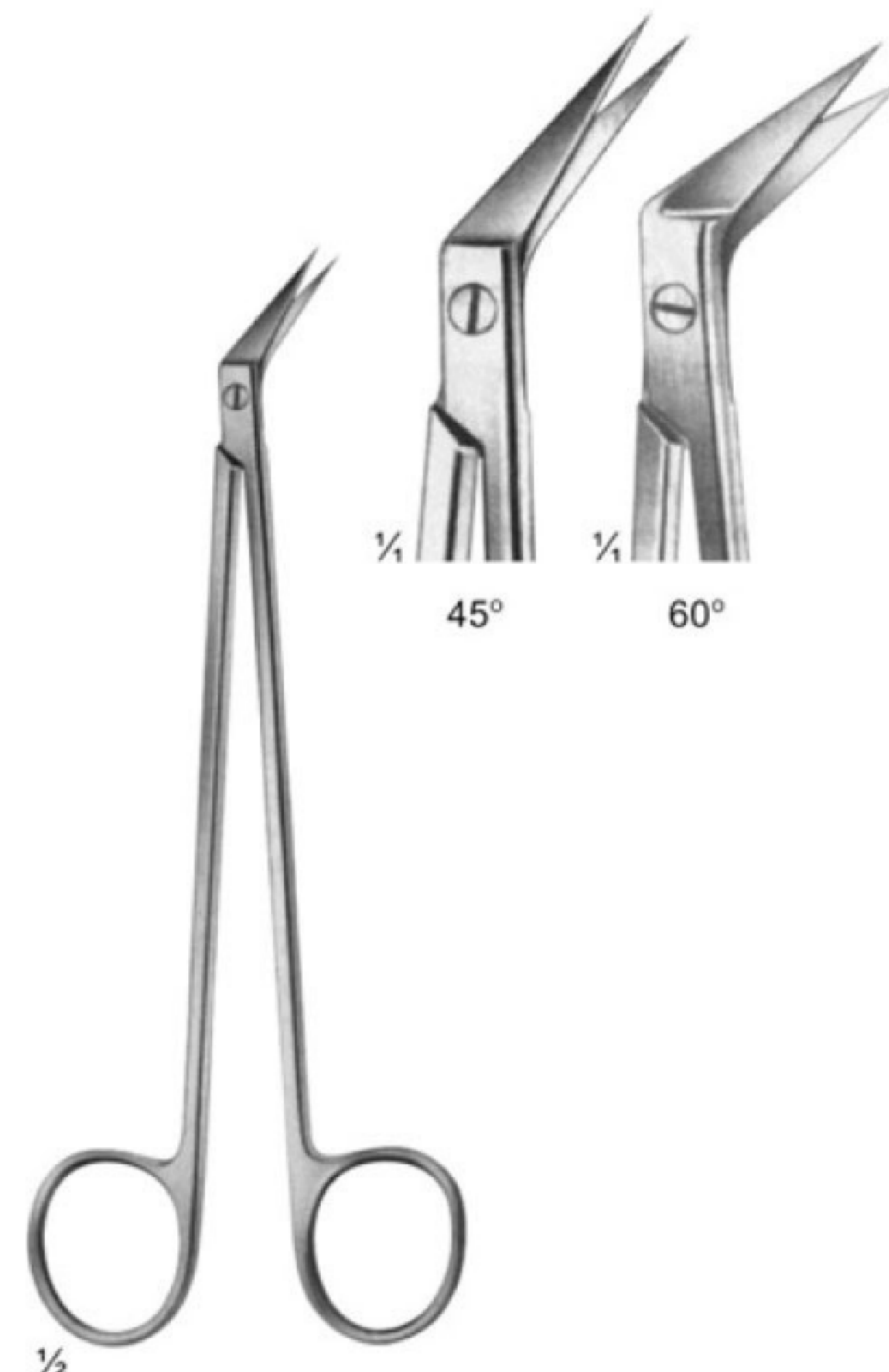

METZENBAUM Size: 145 mm
MWD-2622
 METZENBAUM Size: 145 mm



NELSON-METZENBAUM Size: 230 mm
MWD-2623
 NELSON-METZENBAUM Size: 230 mm

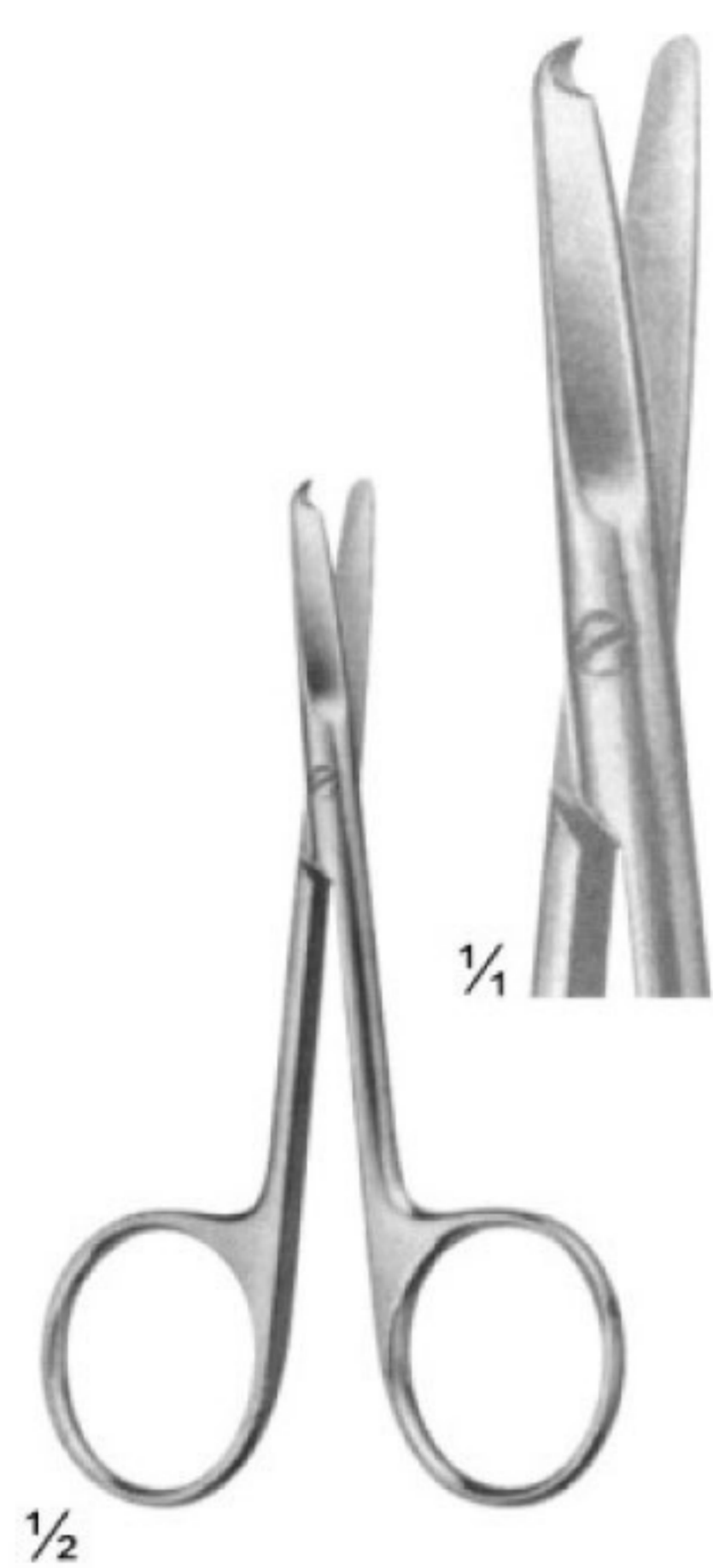

DE BAKEY Size: 155 mm
MWD-2624
 DE BAKEY Size: 155 mm

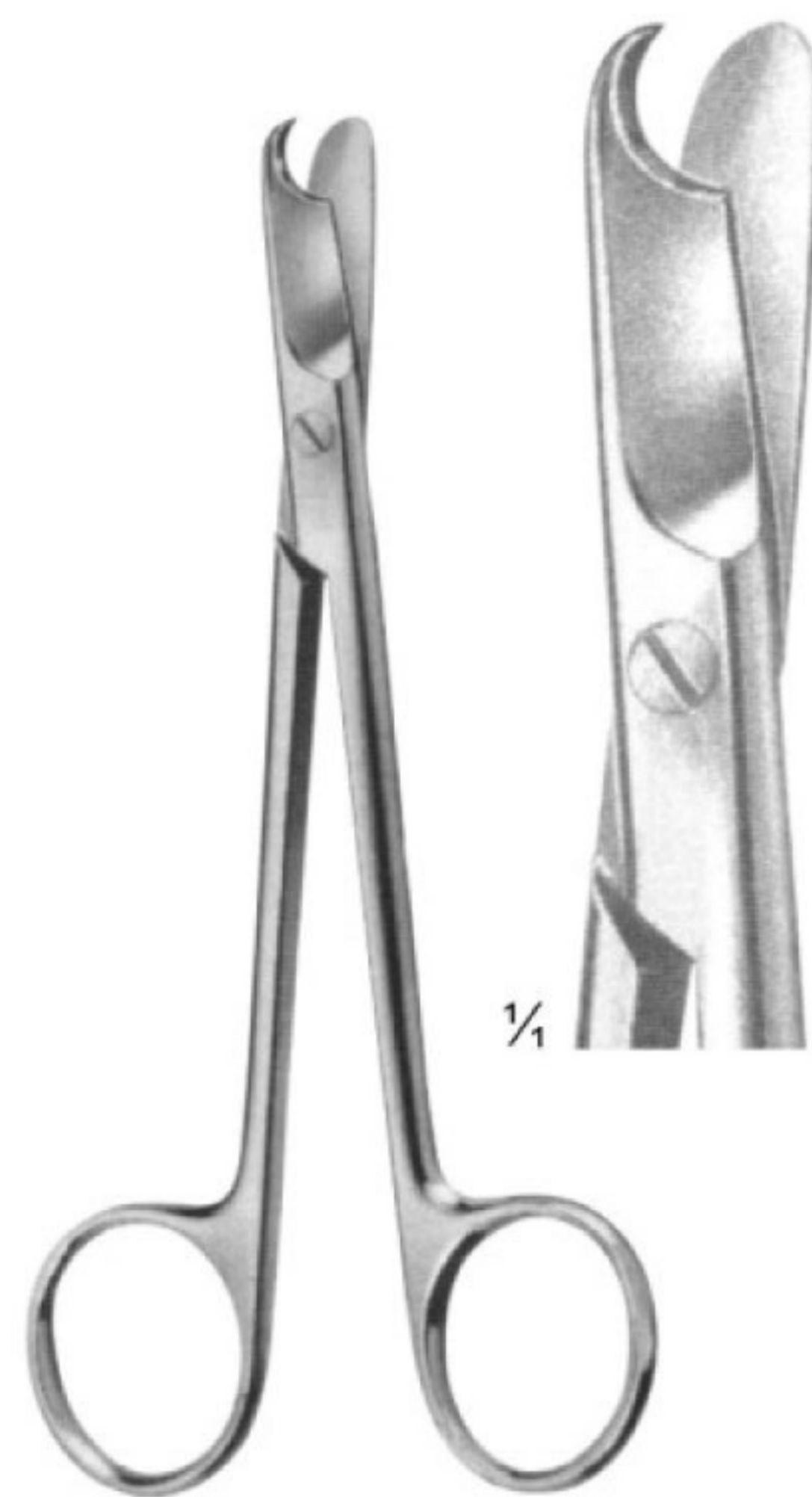

LOCKLIN Curved Sideways, 1 Toothed
Blade Size: 155 mm
MWD-2625
 LOCKLIN Curved Sideways, 1 Toothed Blade
 Size: 155 mm



2626 SPENCER Size: 90 mm
MWD-2626
 2626 SPENCER Size: 90 mm



LITTAUER Size: 135 mm
MWD-2627
 LITTAUER Size: 135 mm



BEEBE Size: 110 mm
MWD-2628
 BEEBE Size: 110 mm



MWD-2629



MWD-2630



MWD-2631

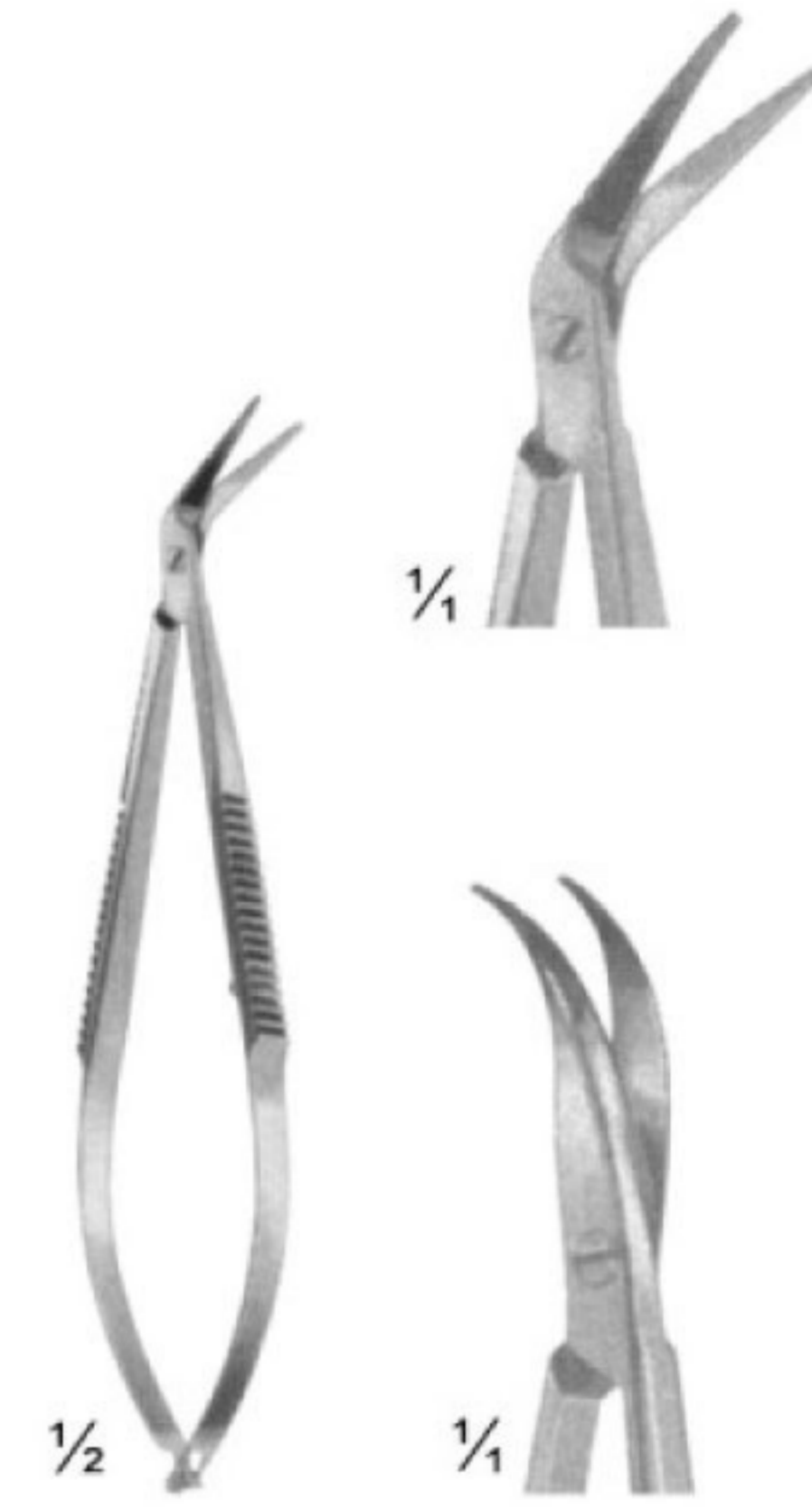

MWD-2632



1 Blade Serrated Size: 120 mm
MWD-2633
 1 Blade Serrated Size: 120 mm



CASTROVIEJO Size: 90 mm
MWD-2634
 CASTROVIEJO Size: 90 mm

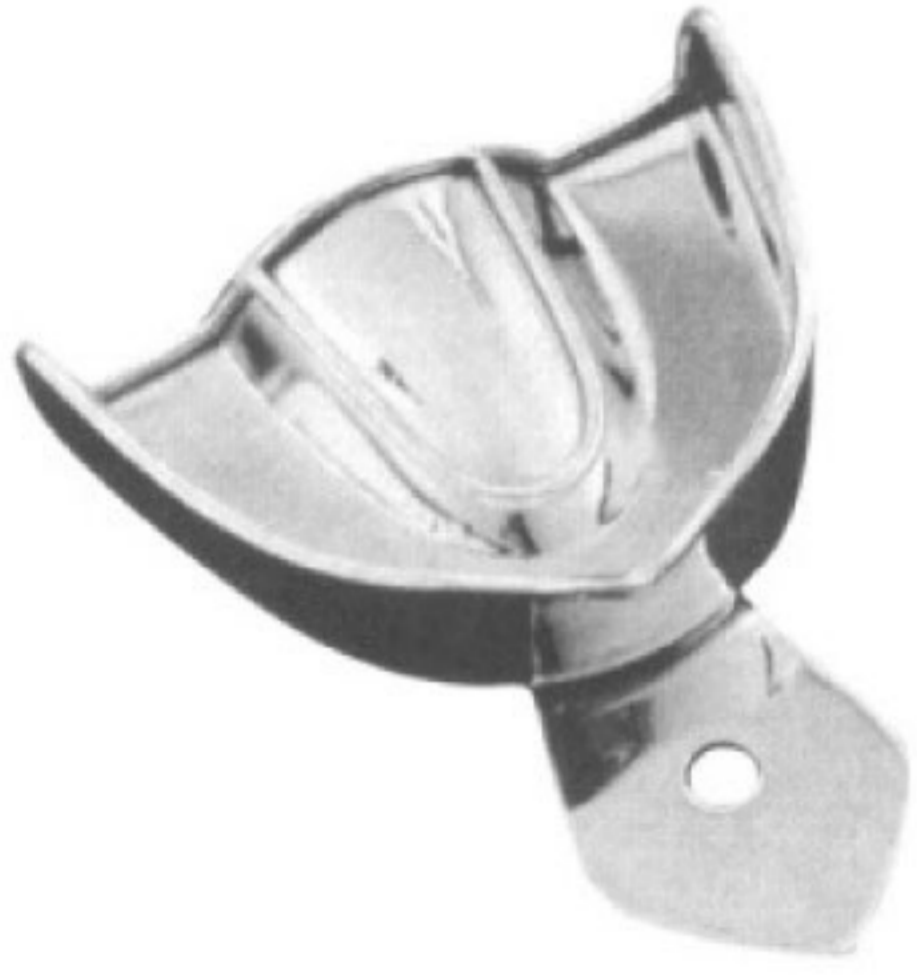

U1
MWD-2635
U1



U2
MWD-2636
U2

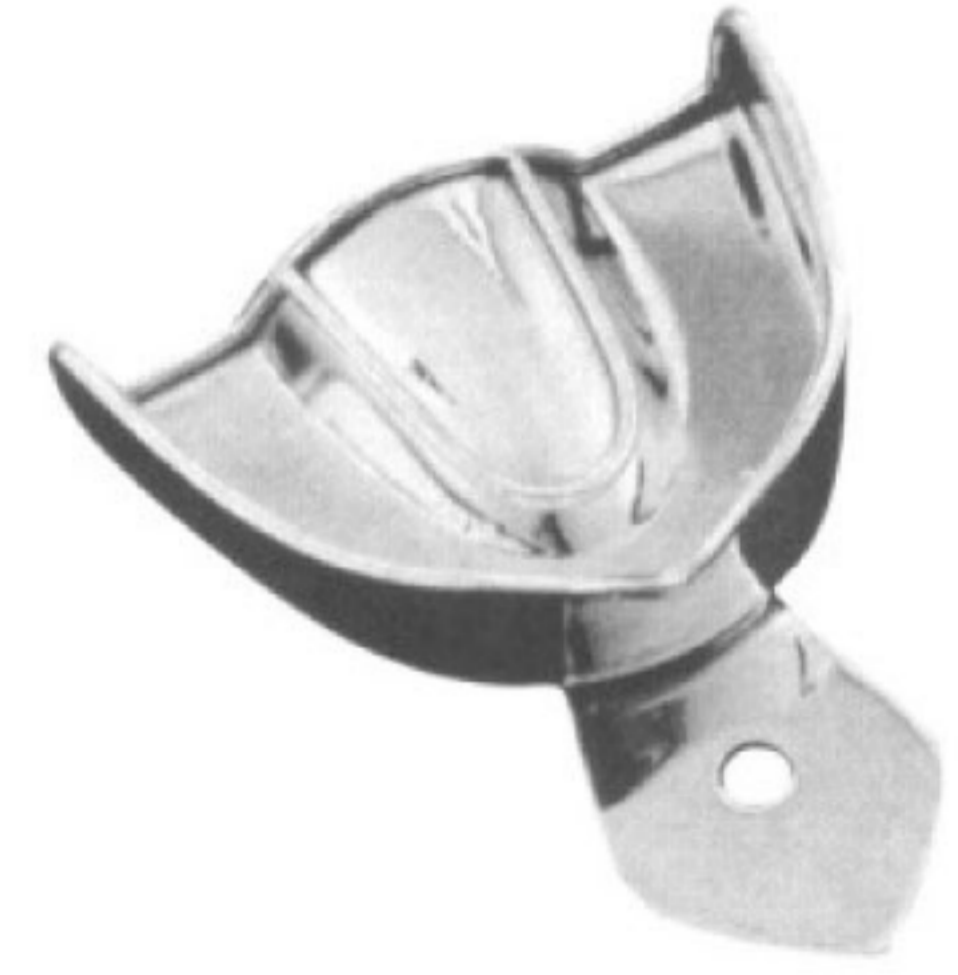

U3
MWD-2637
U3



U4
MWD-2638
U4



U5
MWD-2639
U5



L1
MWD-2640
L1



L2
MWD-2641
L2



L3
MWD-2642
L3



L4
MWD-2643
L4



L5
MWD-2644
L5



U1
MWD-2645
U1



U2
MWD-2646
U2



U3
MWD-2647
U3

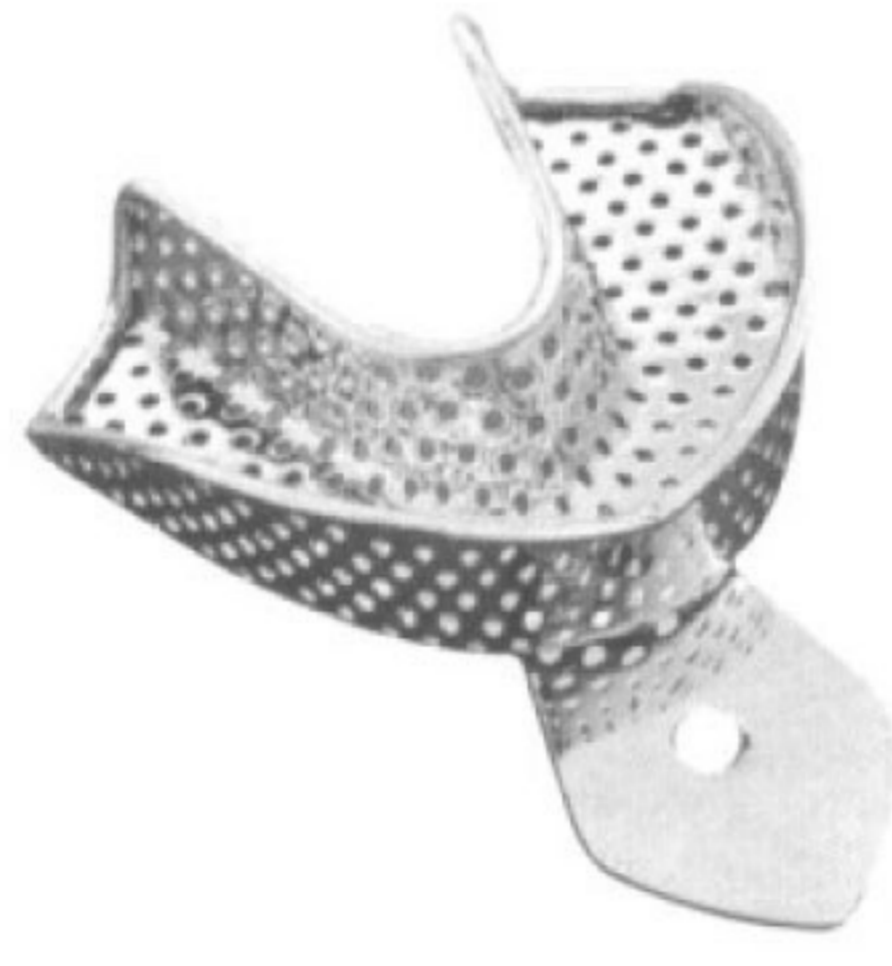

U4
MWD-2648
U4



U5
MWD-2649
U5



L1
MWD-2650
L1



L2
MWD-2651
L2



L3
MWD-2652
L3



L4
MWD-2653
L4



L5
MWD-2654
L5



XL
MWD-2655
XL



L
MWD-2656
L



M
MWD-2657
M



S
MWD-2658
S



XL
MWD-2659
XL



L
MWD-2660
L



M
MWD-2661
M



S
MWD-2662
S



XL
MWD-2663
XL



L
MWD-2664
L



M
MWD-2665
M



S
MWD-2666
S



XL
MWD-2667
XL



L
MWD-2668
L



M
MWD-2669
M



S
MWD-2670
S



U1
MWD-2671
U1



U2
MWD-2672
U2

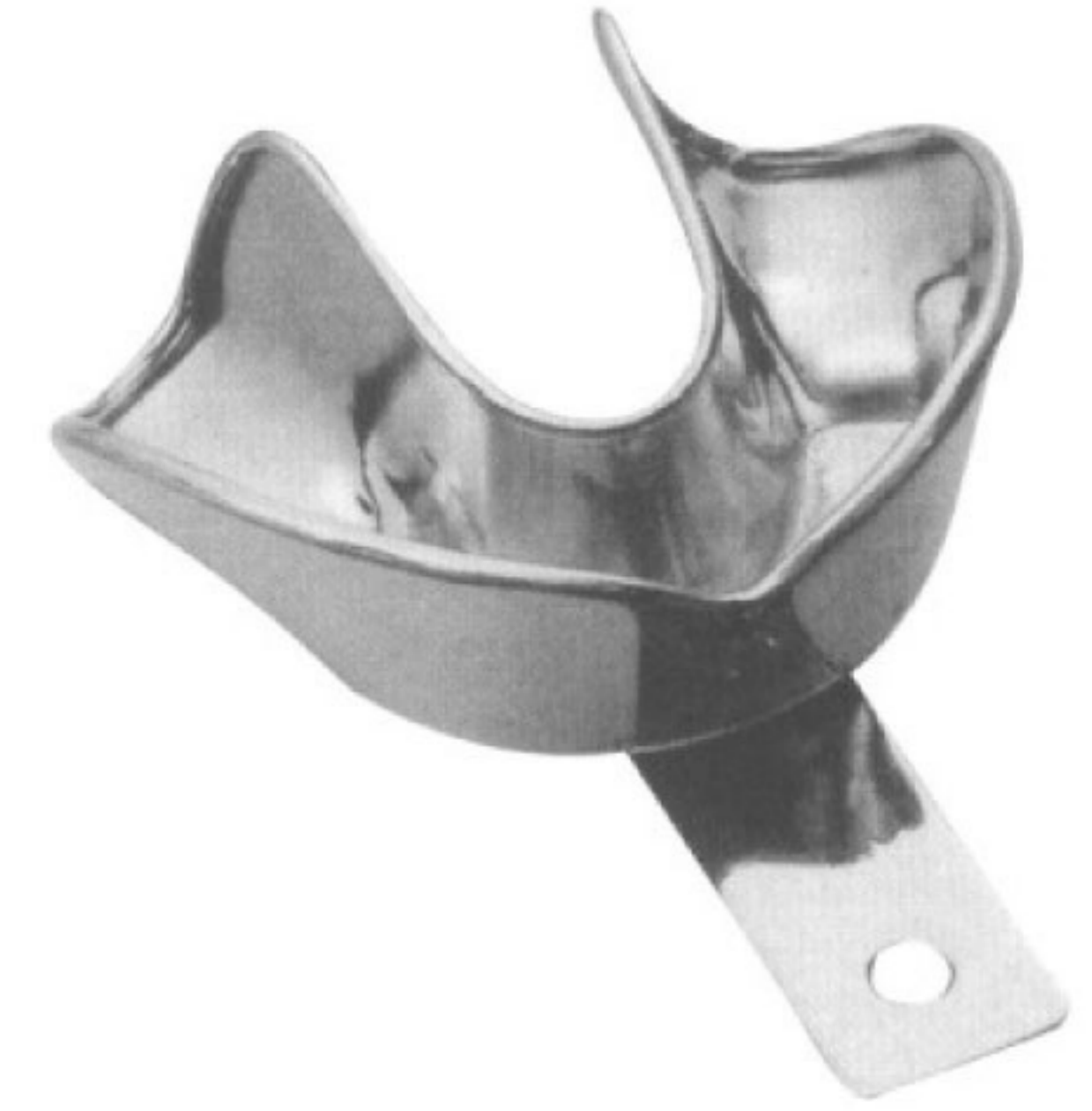

U3
MWD-2673
U3



L1
MWD-2674
L1



L2
MWD-2675
L2



L3
MWD-2676
L3



U1
MWD-2677
U1



U2
MWD-2678
U2



U3
MWD-2679
U3



L1
MWD-2680
L1



L2
MWD-2681
L2



L3
MWD-2682
L3

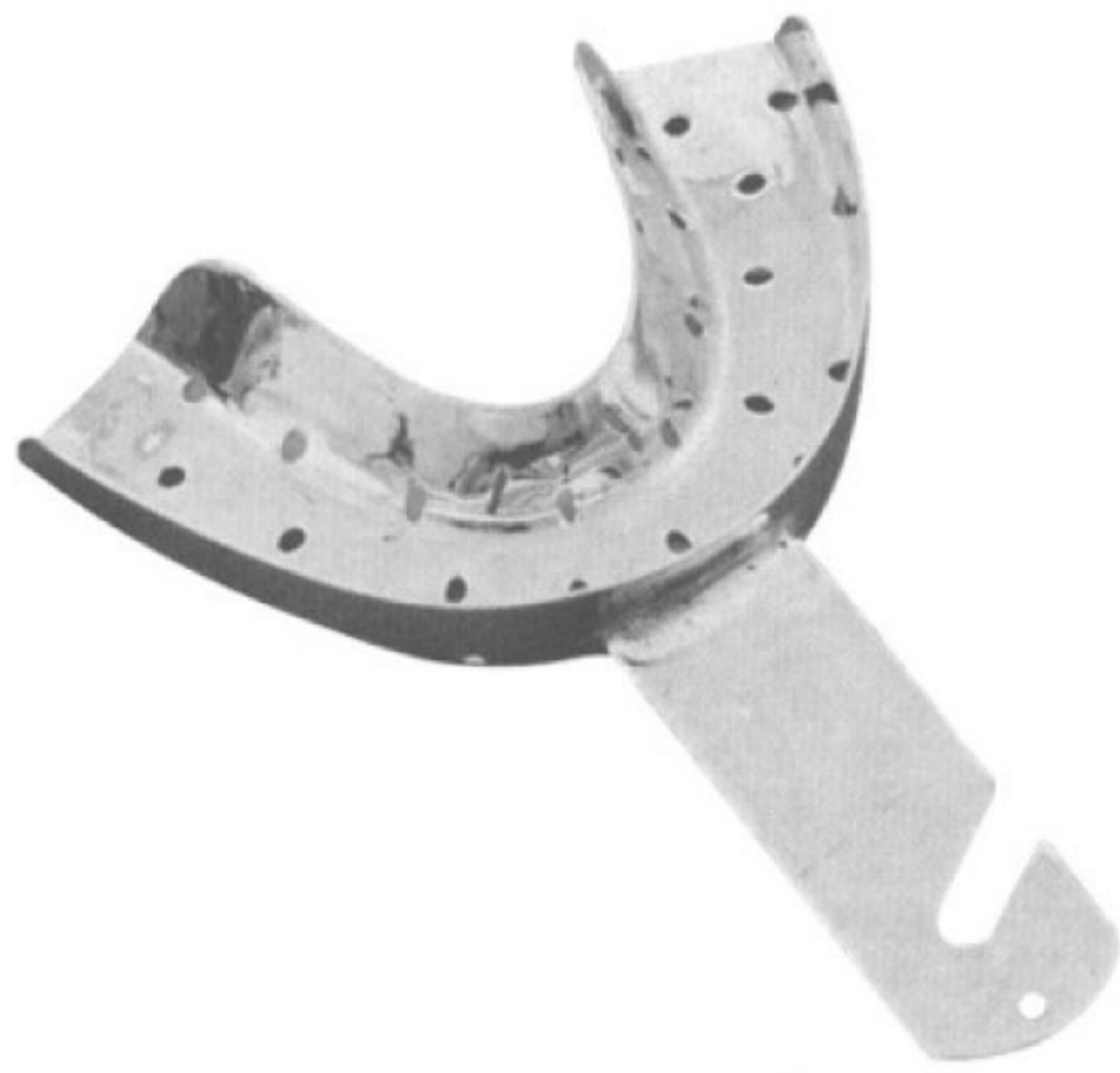

Lower
MWD-2683
Lower



Upper
MWD-2684
Upper



Lower
MWD-2685
Lower



Upper
MWD-2686
Upper

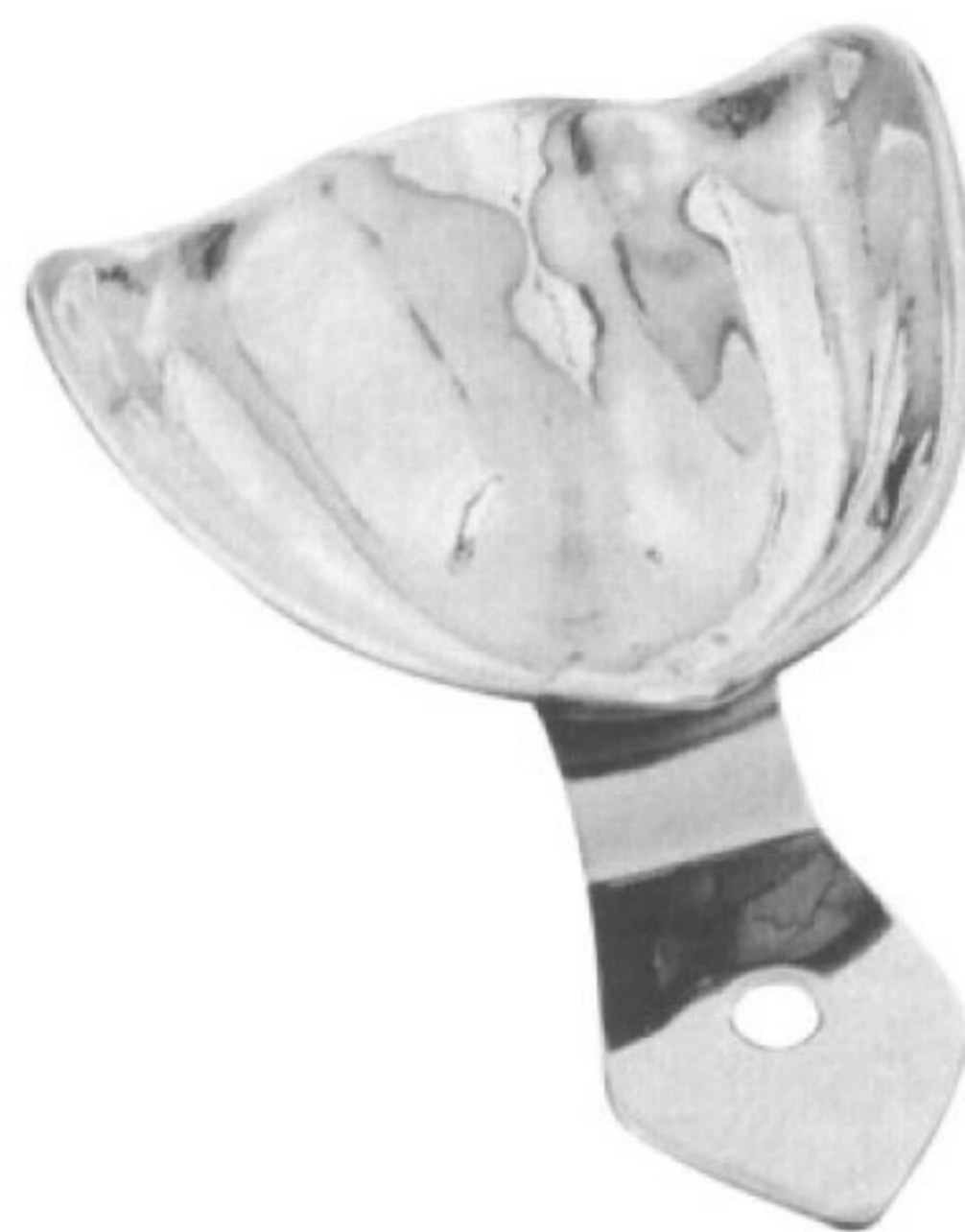

Lower
MWD-2687
Lower

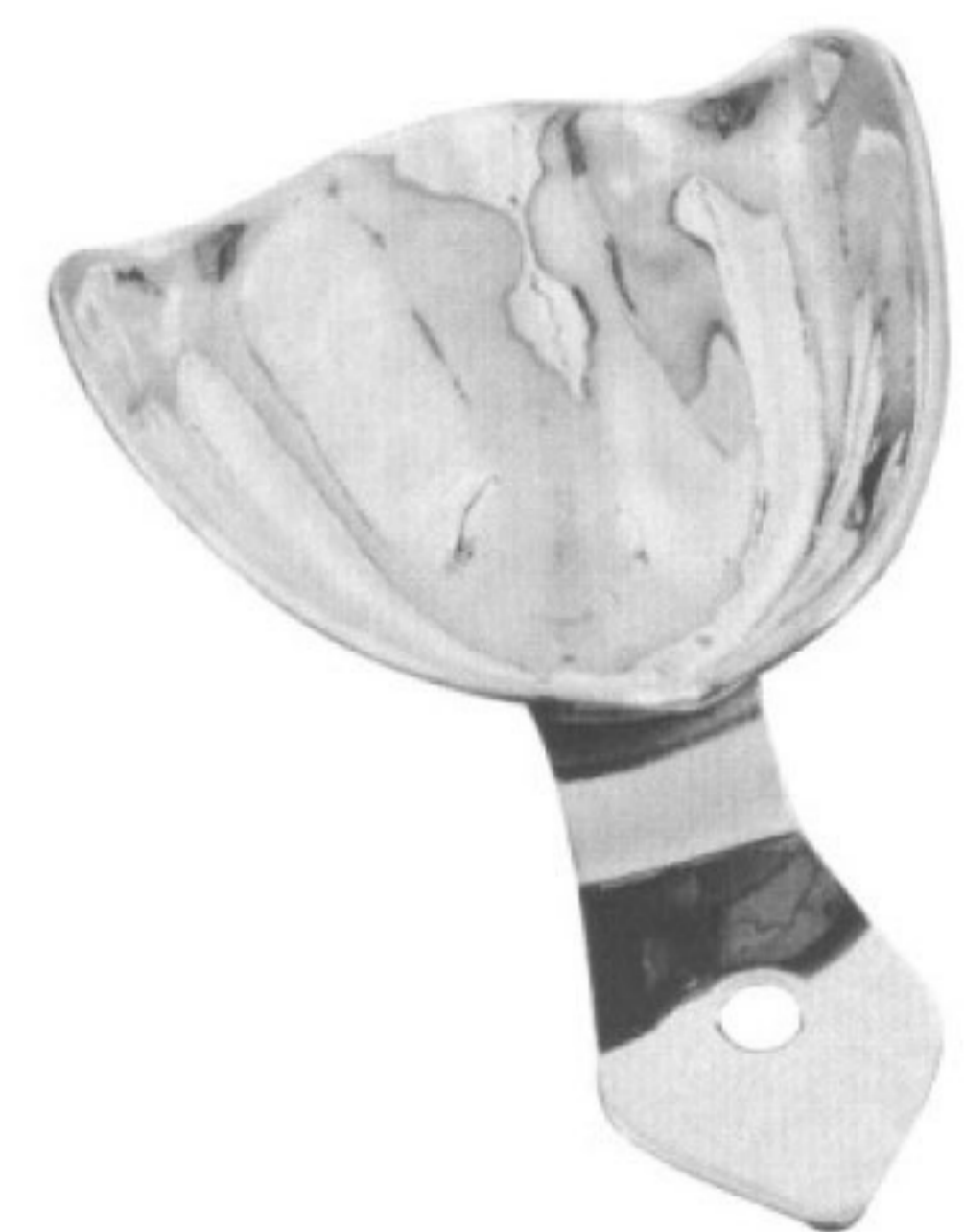

Upper
MWD-2688
Upper

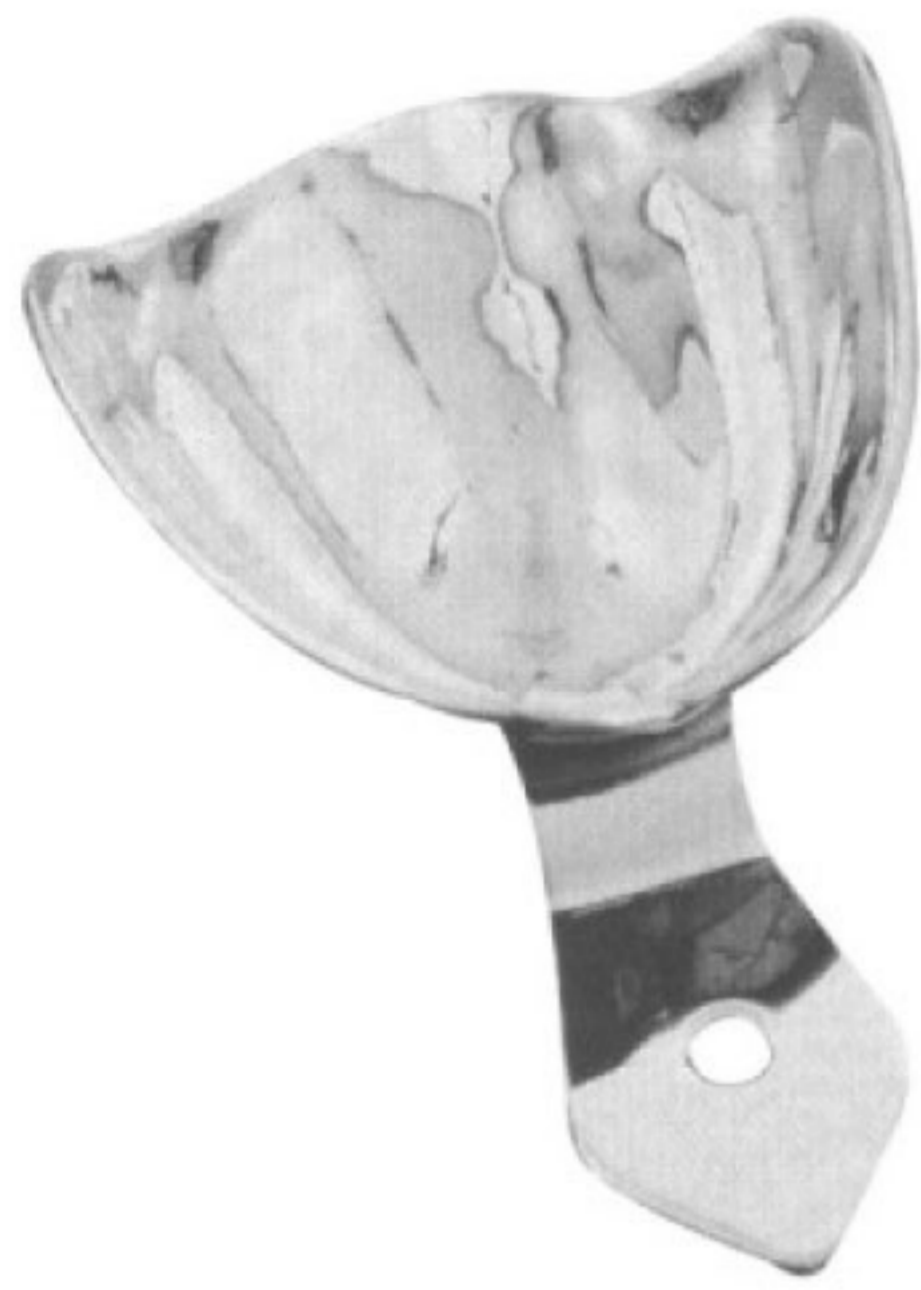

XL
MWD-2689
XL



L
MWD-2690
L



M
MWD-2691
M



S
MWD-2692
S

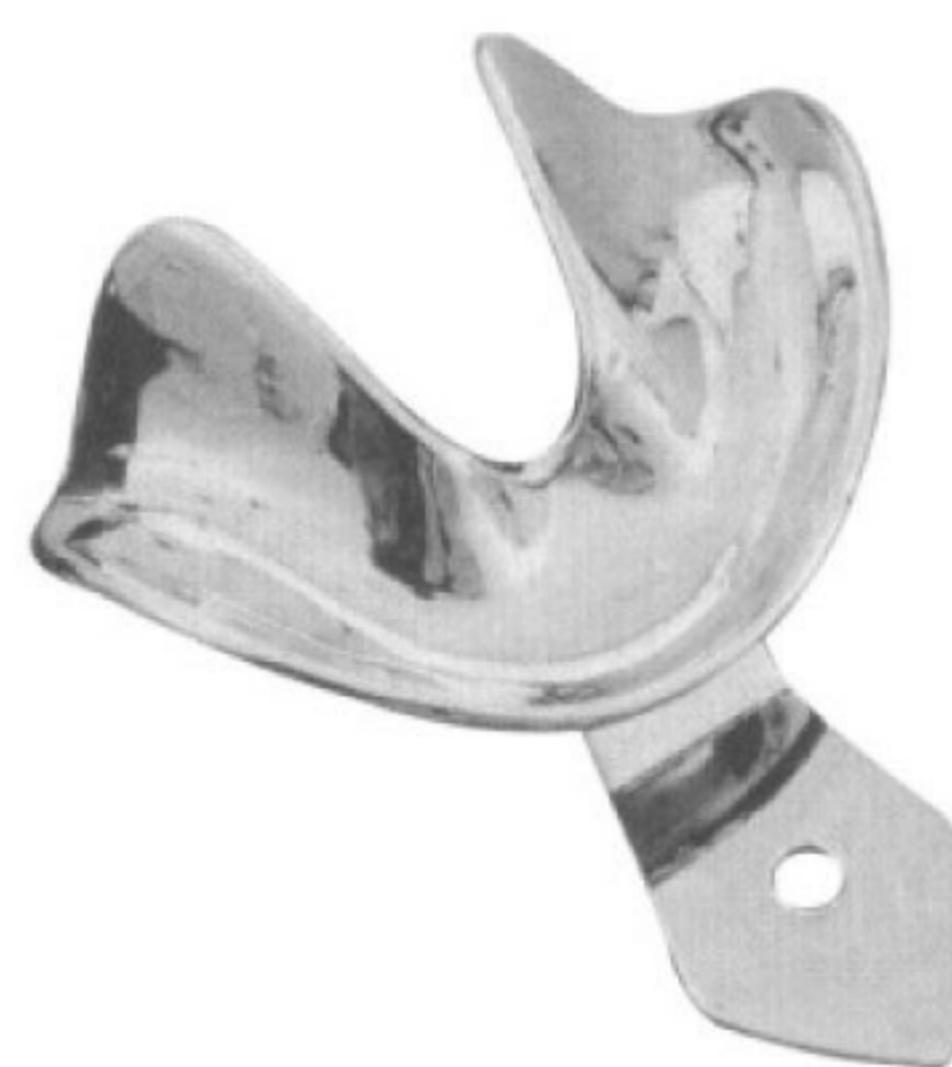

XL
MWD-2693
XL



L
MWD-2694
L



M
MWD-2695
M



S
MWD-2696
S



XL
MWD-2697
XL



L
MWD-2698
L



M
MWD-2699
M



S
MWD-2700
S



XL
MWD-2701
XL



L
MWD-2702
L



M
MWD-2703
M



S
MWD-2704
S



U0
MWD-2705
U0



U1
MWD-2706
U1



U2
MWD-2707
U2



U3
MWD-2708
U3



L0
MWD-2709
L0



L1
MWD-2710
L1



L2
MWD-2711
L2



L3
MWD-2712
L3



U0
MWD-2713
U0



U1
MWD-2714
U1



U2
MWD-2715
U2



U3
MWD-2716
U3



L0
MWD-2717
L0



L2
MWD-2719
L2



L3
MWD- 2720
L3



U1P
MWD-2721
U1P



U1P
MWD-2723
U1P

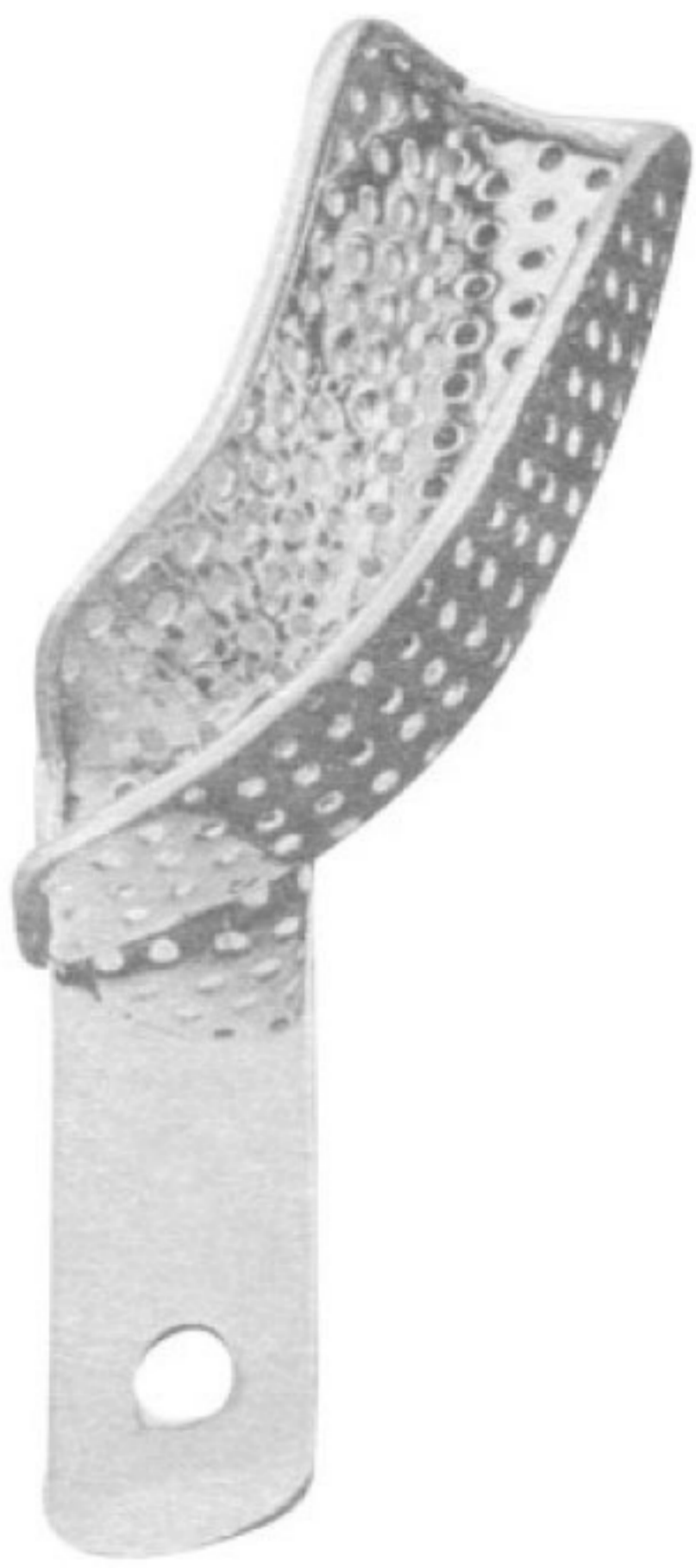

L1P
MWD-2724
L1P



For upper right jaw For lower left jaw
MWD-2725
For upper right jaw For lower left jaw



MWD- 2729



MWD-2730



MWD- 2731

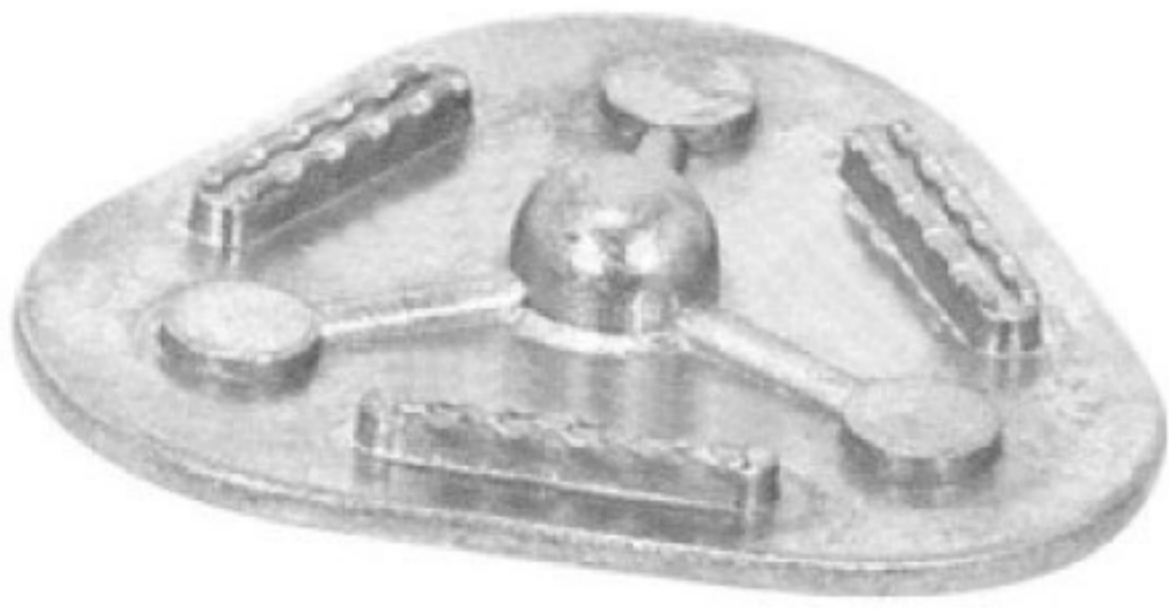

MWD-2732

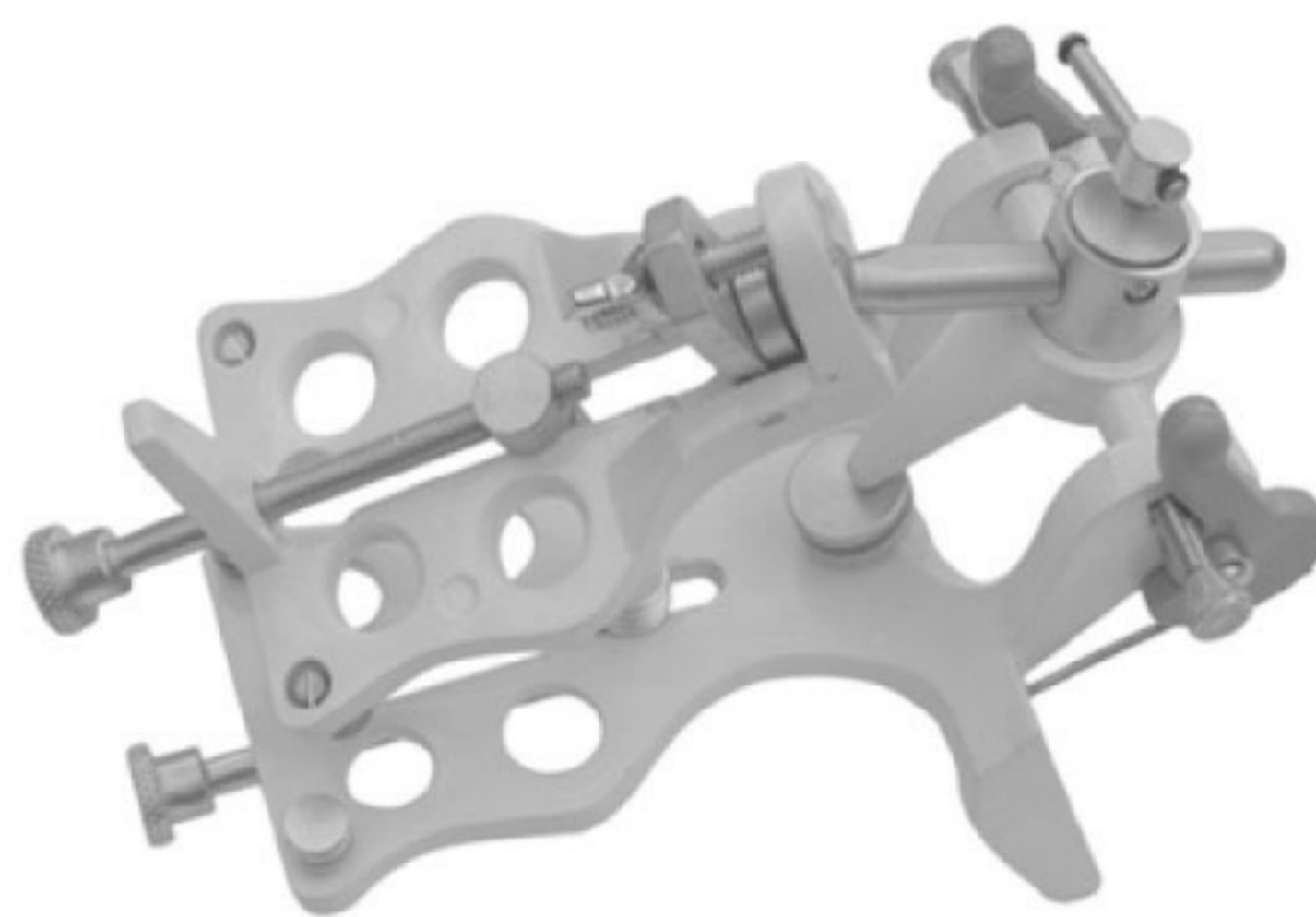

MWD-2733



MWD-2735



MWD-2736



MWD-2737



MWD-2738



MWD-2739



MWD-2740



MWD-2741



Instruments Tray
MWD-2743
Instruments Tray



Instruments Tray
MWD-2744
Instruments Tray



Instruments Tray
MWD-2745
Instruments Tray



Instruments Tray Perforated
MWD-2746
Instruments Tray Perforated

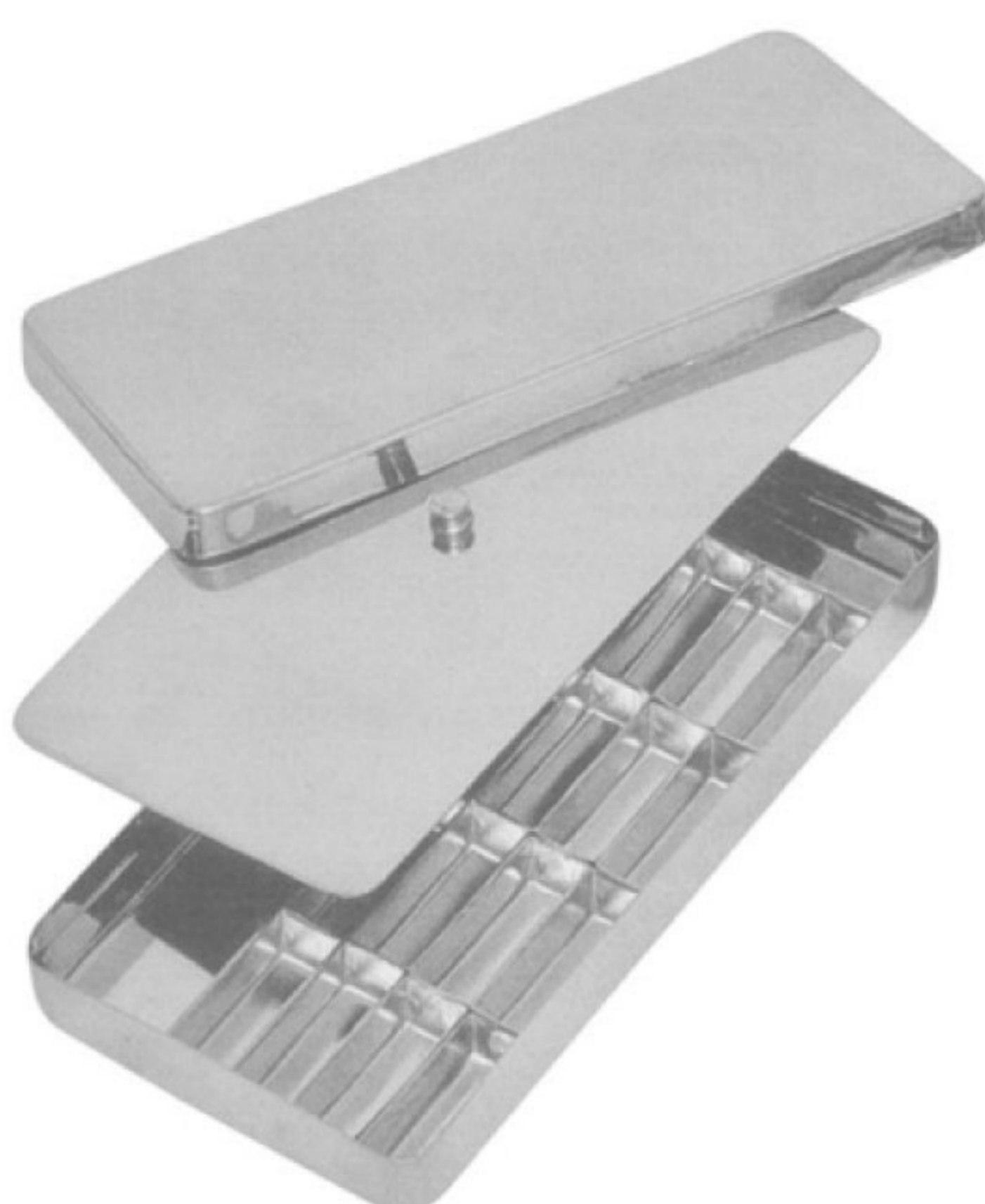

Instruments Tray Perforated Base
MWD-2747
Instruments Tray Perforated Base



Instruments Tray Solid Base
MWD-2748
Instruments Tray Solid Base



Pulpectomy Tray
MWD-2749
 Pulpectomy Tray



Sterilizing Box Available Sizes: 17x17x3 cm 20x10x6 cm 30x14x6 cm
MWD-2750
 Sterilizing Box Available Sizes: 17x17x3 cm 20x10x6 cm 30x14x6 cm



Endo Tray Box
MWD-2751
 Endo Tray Box



Bucket With Handle & Lid Stainlss Steel
18/10 Capacity: 6. Liter 10. Liter 12. Liter 15. Liter
MWD-2752
 Bucket With Handle & Lid Stainlss Steel 18/10 Capa



Sterilizing Drum 150x150mm 175x175mm 190x190mm 200x140mm 200x200mm 240x120mm 225x225mm 240x240mm 290x160mm
MWD-2753
 Sterilizing Drum 150x150mm 175x175mm 190x190mm 200x140mm 200x200mm 240x120mm 225x225mm 240x240mm 290x160mm



Sterilizing Drum 280x240mm 230x150mm 300x250mm 340x160mm 350x250mm 390x200mm 380x300mm 100x100mm 150x120mm
MWD-2754
 Sterilizing Drum 280x240mm 230x150mm 300x250mm 340x160mm 350x250mm 390x200mm 380x300mm 100x100mm 150x120mm



Instruments Box
MWD-2755
Instruments Box



Instruments Box
MWD-2756
Instruments Box



Instruments Box
MWD-2757
Instruments Box



Instruments Sterilizer 150x75 mm
MWD-2758
Instruments Sterilizer 150x75 mm



Endodontic Box
MWD-2759
Endodontic Box



Sterilizing Box 320x120 mm
MWD-2760
Sterilizing Box 320x120 mm



Instruments Tray
MWD-2761
Instruments Tray



Instruments Tray
MWD-2762
Instruments Tray



Instruments Tray (Perforated)
MWD-2763
Instruments Tray (Perforated)



Instruments Tray Shallow(Mayo)
MWD-2764
Instruments Tray Shallow(Mayo)

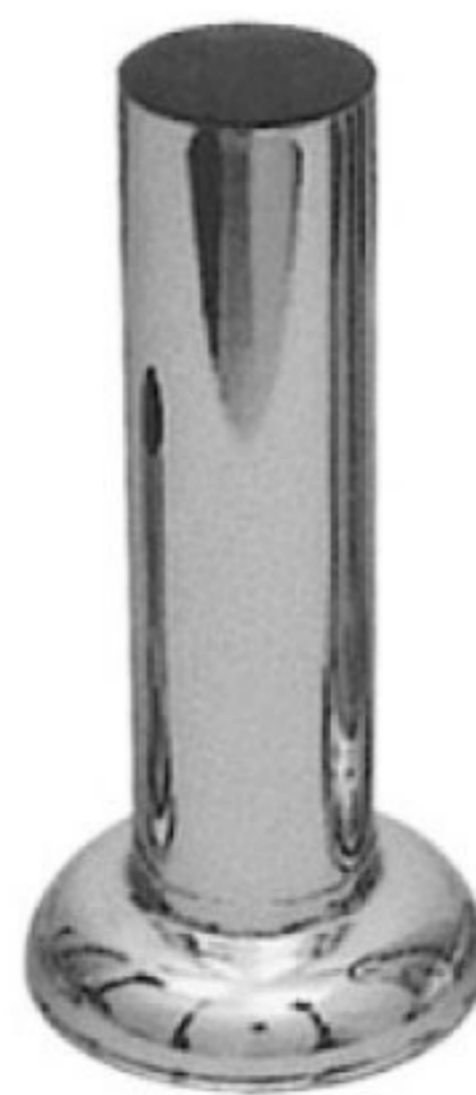

Scalers Tray
MWD-2765
Scalers Tray



Scalers Tray
MWD-2766
Scalers Tray

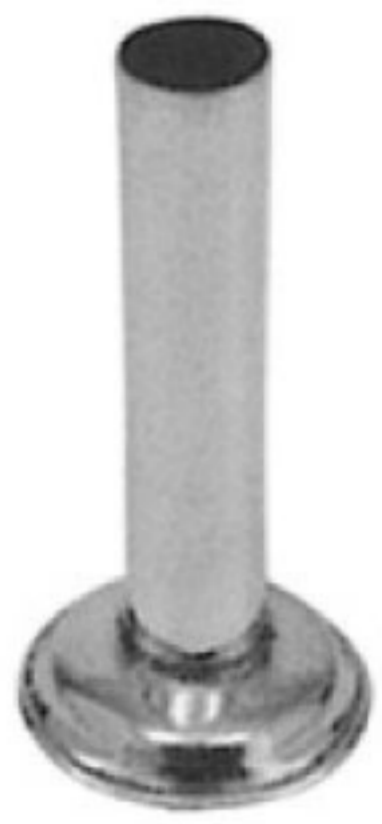

MWD-2767



MWD-2768



MWD-2769



MWD-2770



Cotton Holding Jar 60x50 mm
MWD-2771
 Cotton Holding Jar 60x50 mm



Spitten Mug
MWD-2772
 Spitten Mug



Spirit Burner With Wick Stainless Steel18/10 Capacity:150 ml, 60 ml
MWD-2773

Spirit Burner With Wick Stainless Steel18/10 Capacity:150 ml, 60 ml

Spirit Burners With Wick Stainless Steel18/10 Capacity:70ml
MWD-2774

Spirit Burners With Wick Stainless Steel18/10 Capacity:70ml

Dressing Jar
MWD-2775
Dressing Jar



Dressing Jar
MWD-2776
Dressing Jar

Irrigator(Douch Can)
MWD-2777
Irrigator(Douch Can)

Measuring Jug
MWD-2778
Measuring Jug



Gallipot
MWD-2779
Gallipot



Medicine Cup
MWD-2780
Medicine Cup



Fennel 100 mm
MWD-2781
Fennel 100 mm



Tube Rack, Round Model Stainless Steel
18/10
MWD-2782
Tube Rack, Round Model Stainless Steel
18/10



Tube Rack, Stainless Steel 18/10
MWD-2783
Tube Rack, Stainless Steel 18/10



Urinals Male Capacity 1 Ltr
MWD-2787
Urinals Male Capacity 1 Ltr



Urinals Male Capacity 0.75 Ltr
MWD-2788
 Urinals Male Capacity 0.75 Ltr



Bed Pan Hand Made Adult / Child
MWD-2789
 Bed Pan Hand Made Adult / Child



Bed Pan (Type Sleeper) With & Without Cover Child 300 mm / Adult 350 mm
MWD-2790
 Bed Pan (Type Sleeper) With & Without Cover Child 300 mm / Adult 350 mm



Bed Pan (Type Round) 300 x 85 mm
MWD-2791
 Bed Pan (Type Round) 300 x 85 mm



Sponge Bowl
MWD-2792
 Sponge Bowl



Sponge Bowl
MWD-2793
 Sponge Bowl



Wash Basin 300mm-350mm-400mm
MWD-2794
 Wash Basin 300mm-350mm-400mm



Kick Bucket With Trolley
MWD-2795
 Kick Bucket With Trolley



Kidney Tray Shallow 150mm-200mm-240mm-300mm
MWD-2796
 Kidney Tray Shallow 150mm-200mm-240mm-300mm



Kidney Tray Without Lid 150mm-200mm-250mm-300mm
MWD-2797
 Kidney Tray Without Lid 150mm-200mm-250mm-300mm



Kidney Tray With Lid 150mm-200mm-250mm-300mm
MWD-2798
 Kidney Tray With Lid 150mm-200mm-250mm-300mm



Dustbin Without Stand 6-10-12 Ltr
MWD-2799
 Dustbin Without Stand 6-10-12 Ltr

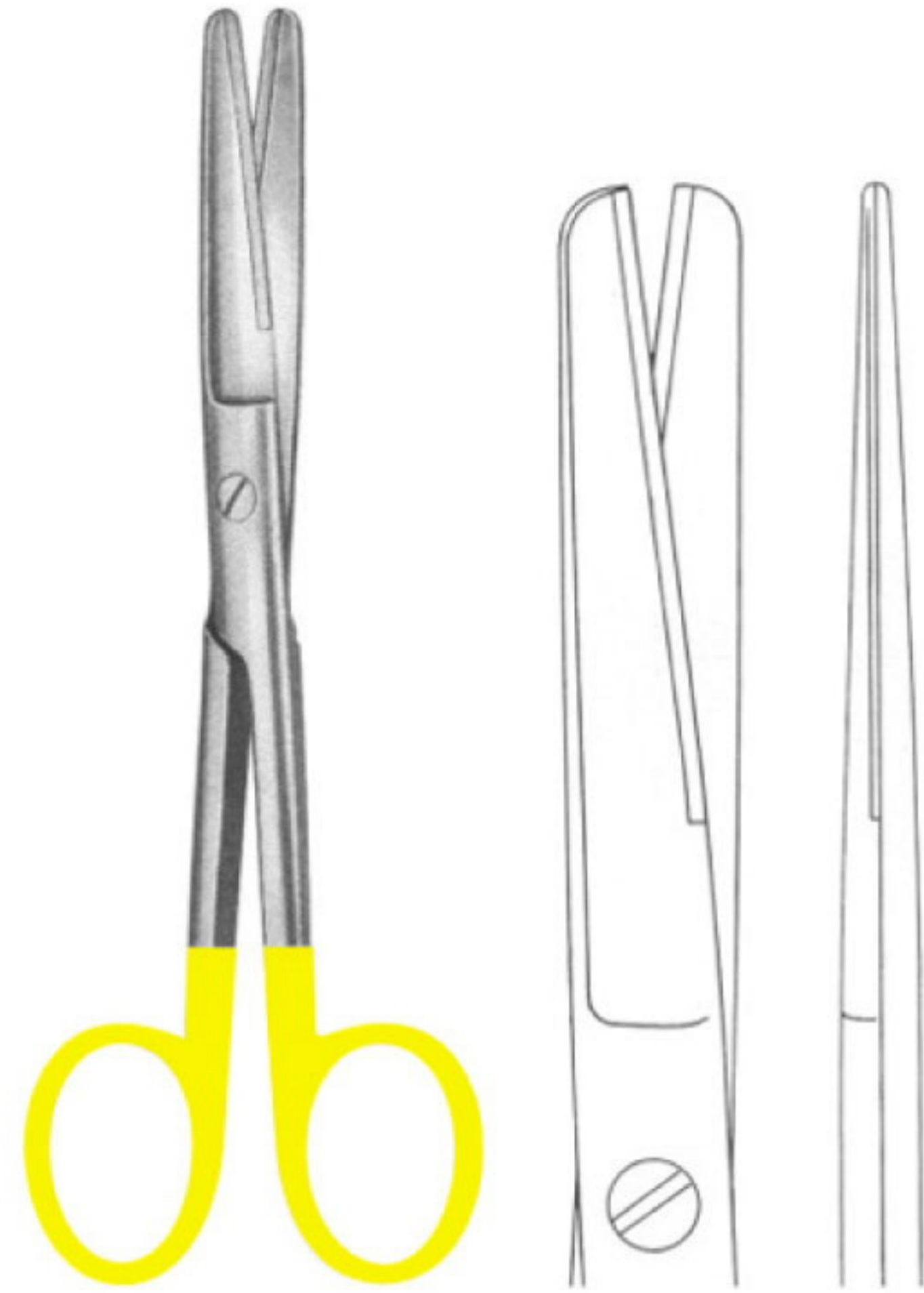

**Needle Case Rectangle Needle Case
Round With Cover 90x15
MWD-2801**

Needle Case Rectangle Needle Case Round
With Cover 90x15

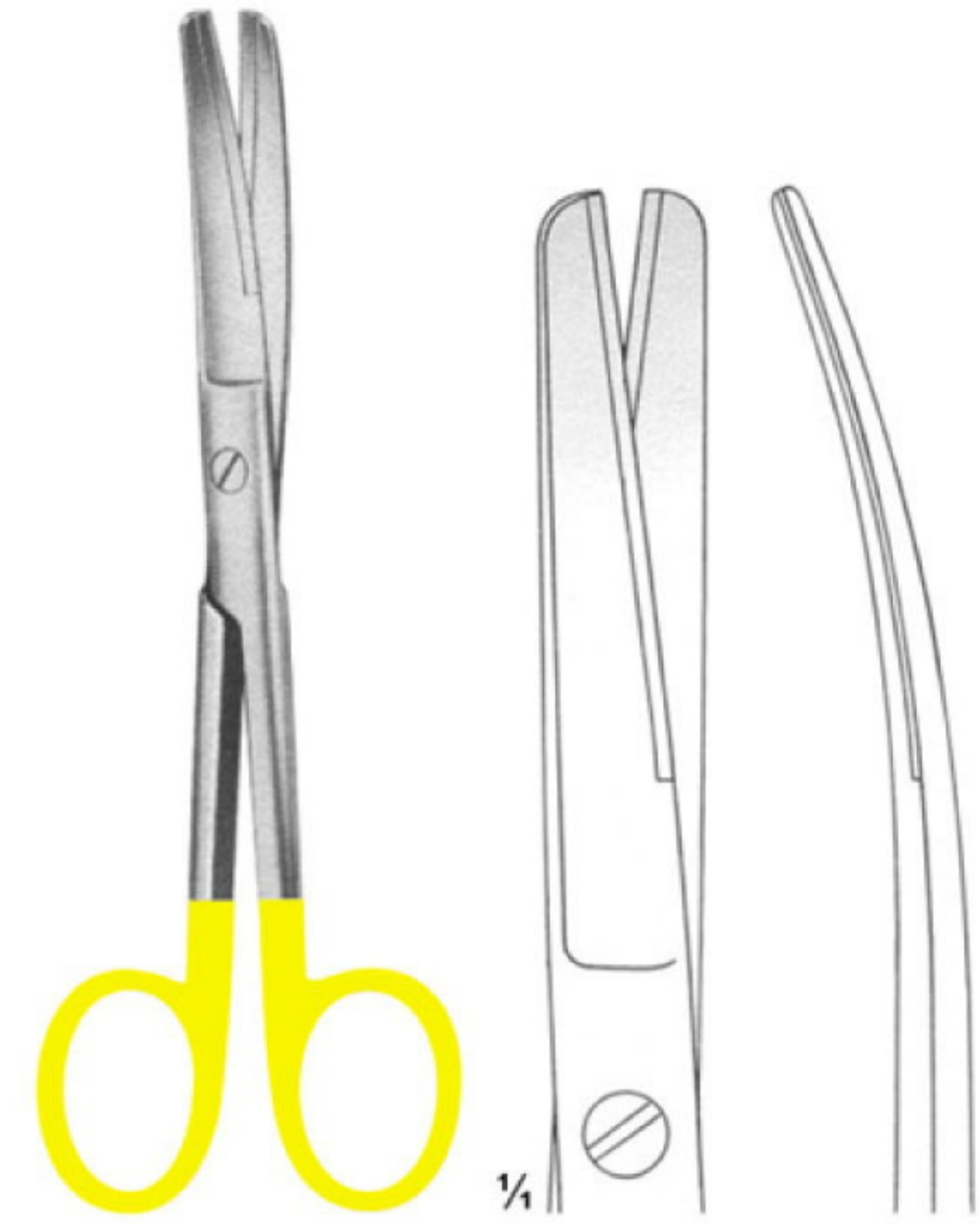

**Lotion Bowl With Lip 40-60-80-100-120-
150-180-200mm
MWD-2802**

Lotion Bowl With Lip 40-60-80-100-120-150-
180-200mm

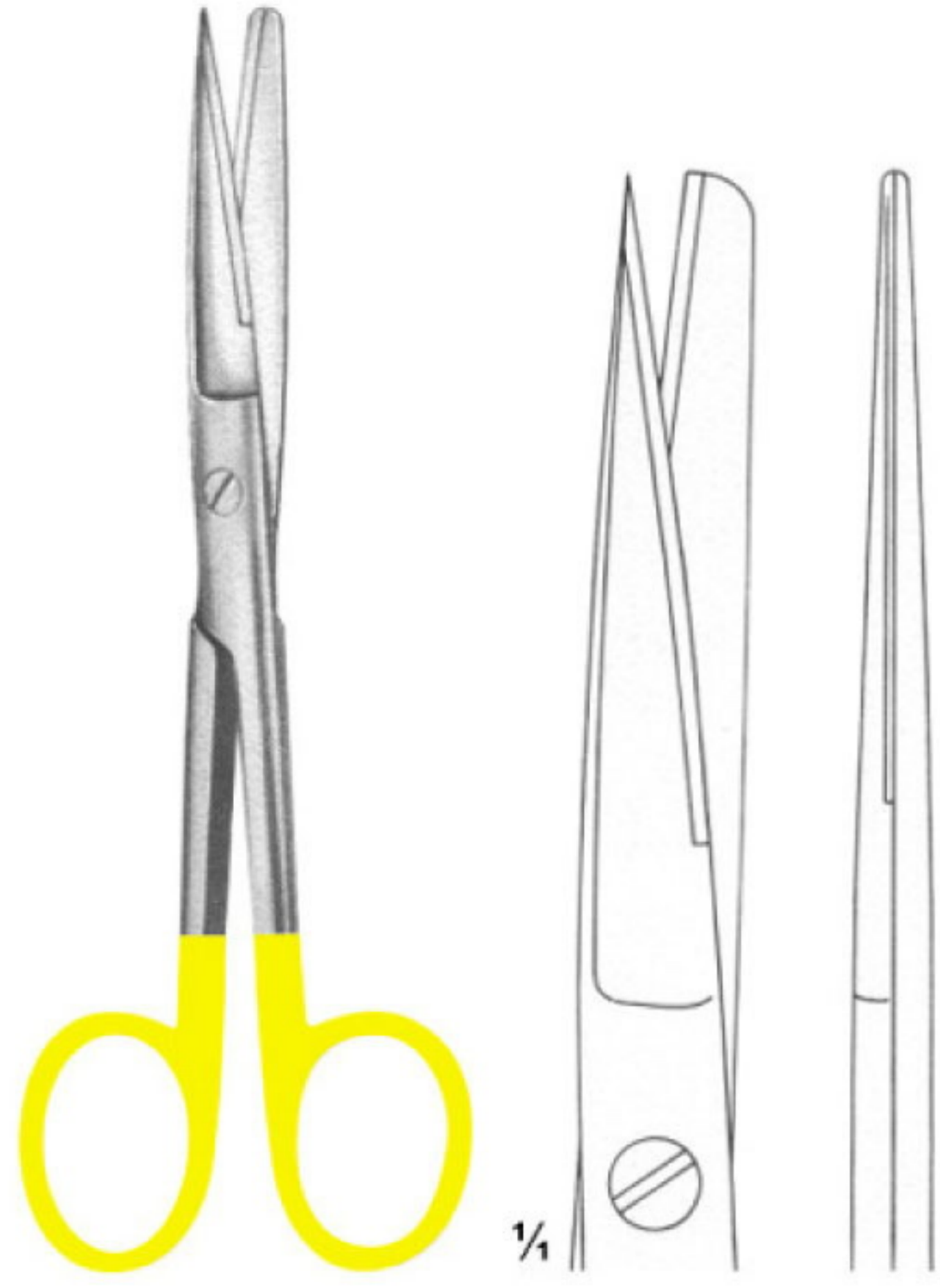

Standard
MWD-2803
Standard



Standard
MWD-2804
Standard

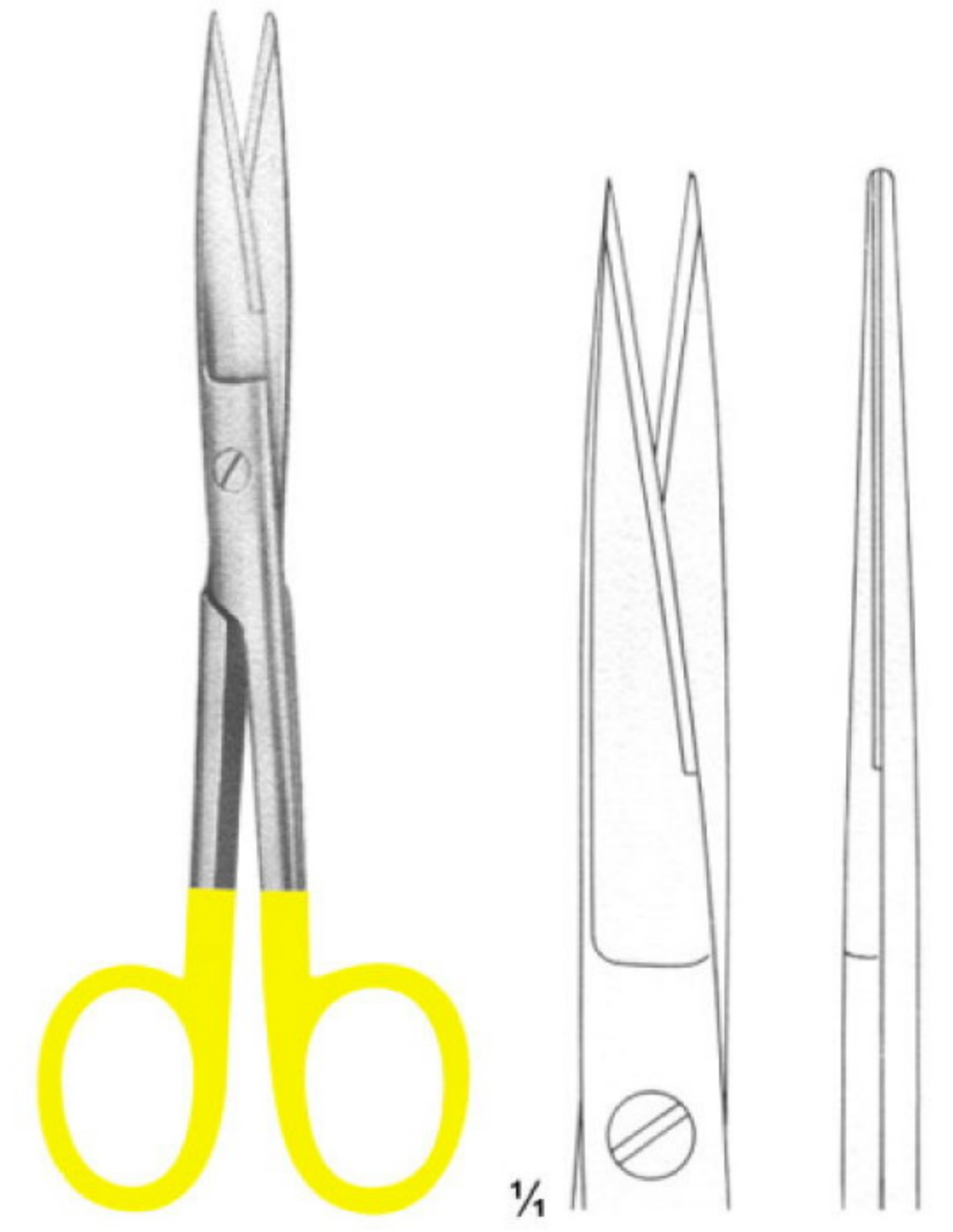

Standard
MWD-2805
Standard



Standard
MWD-2806
Standard

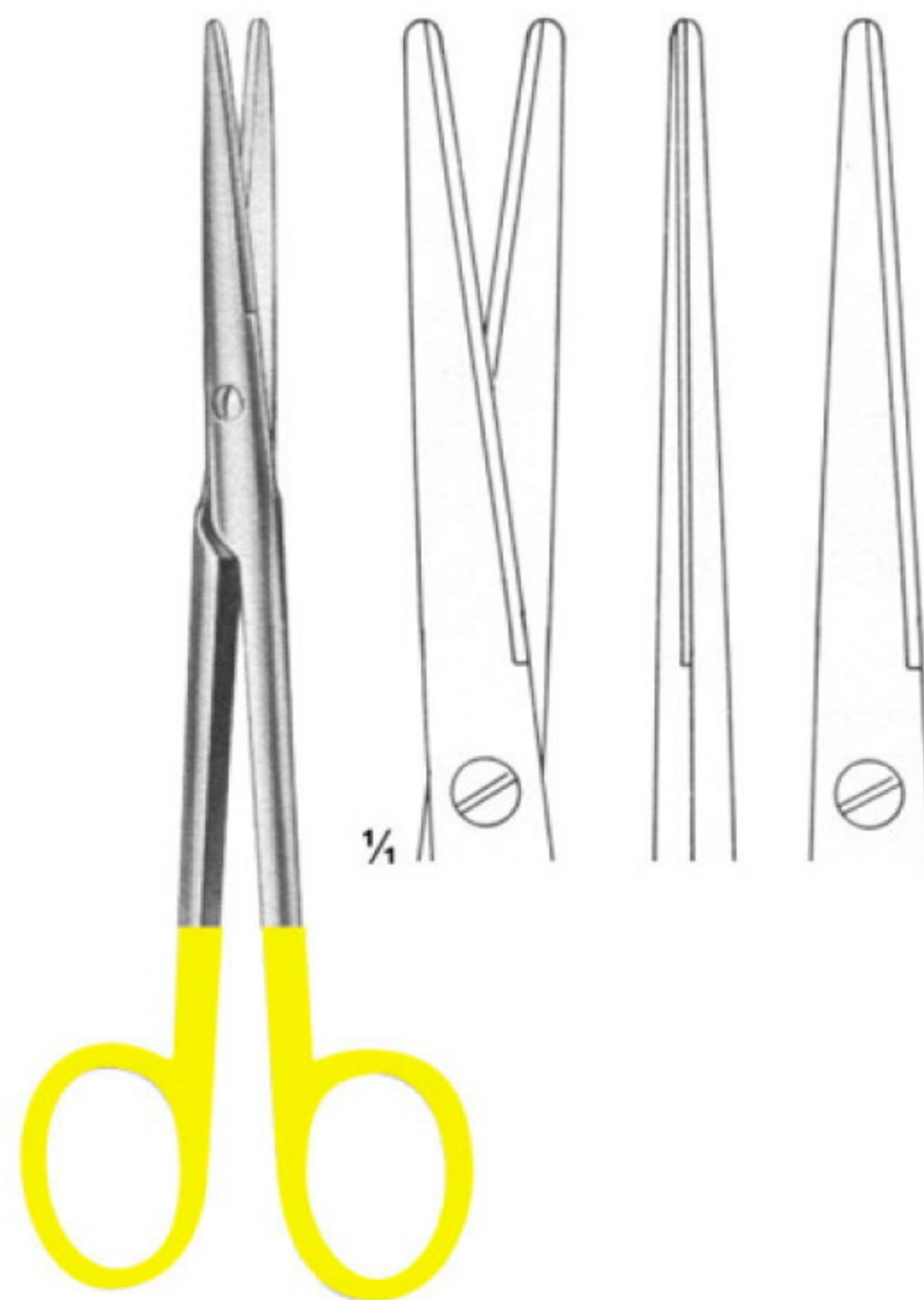

Standard
MWD-2807
Standard

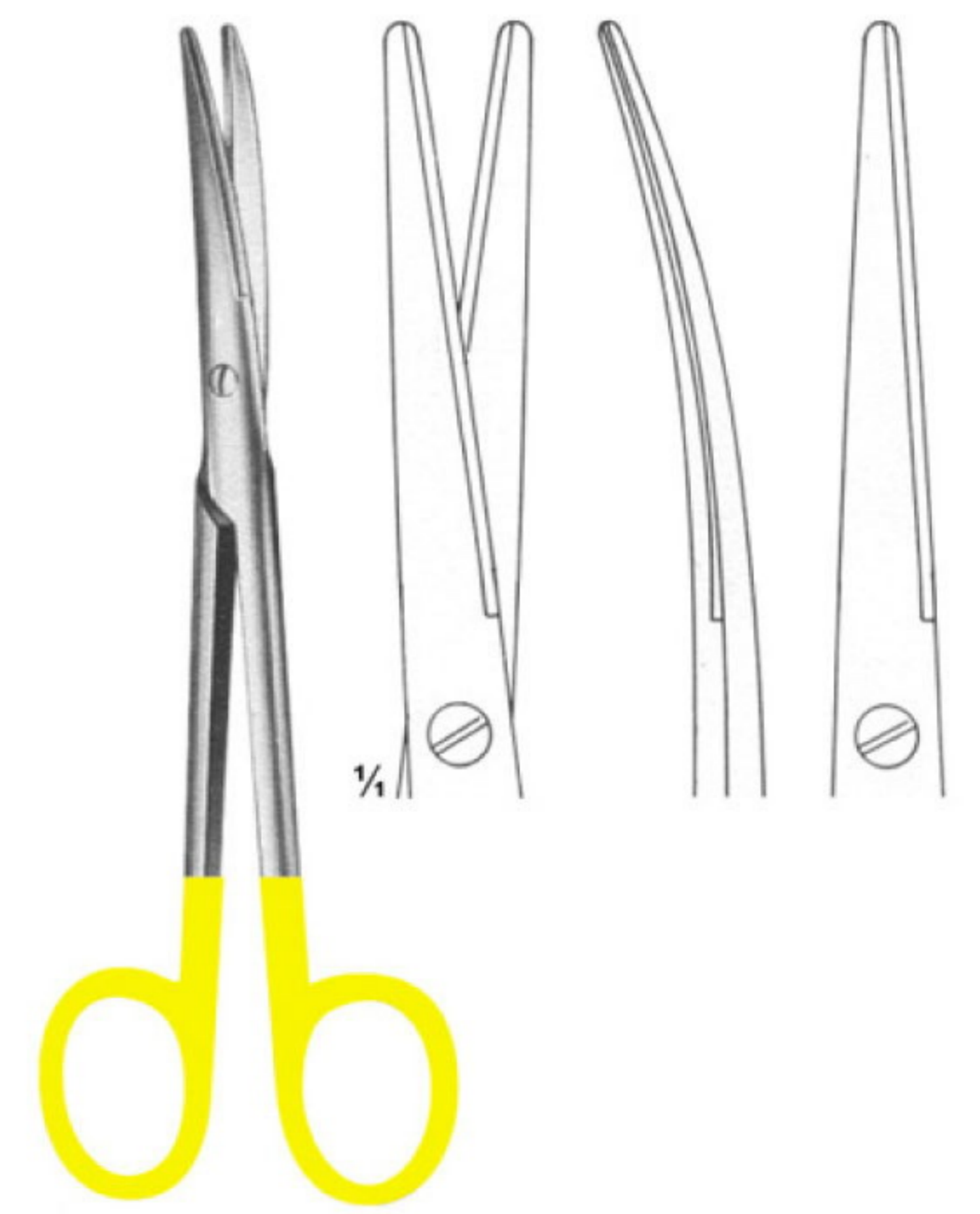

Standard
MWD-2808
Standard 14,5cm 16,5cm 18,5cm

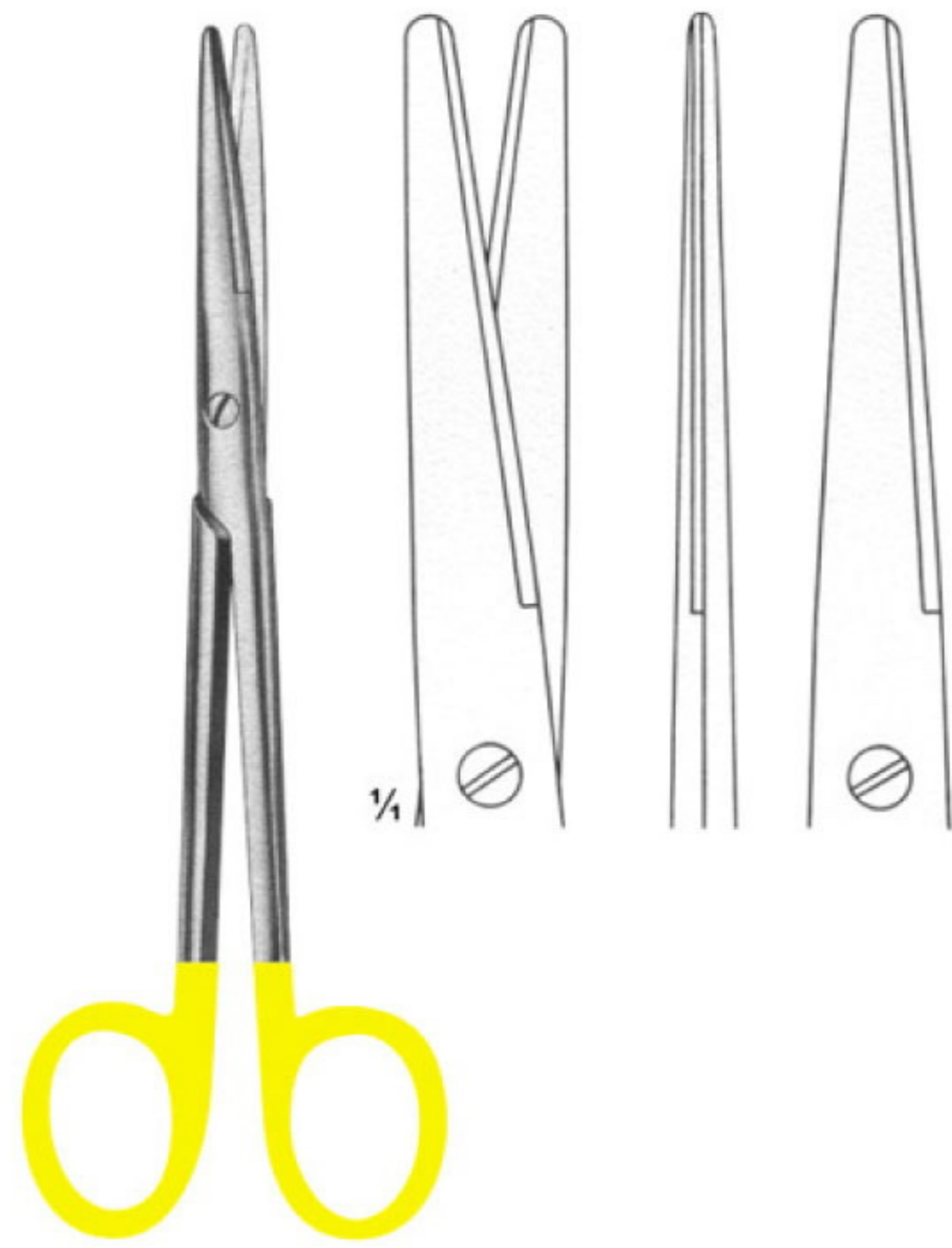

MAYO-LEXER Straight 16 cm
MWD-2809
 MAYO-LEXER Straight 16 cm

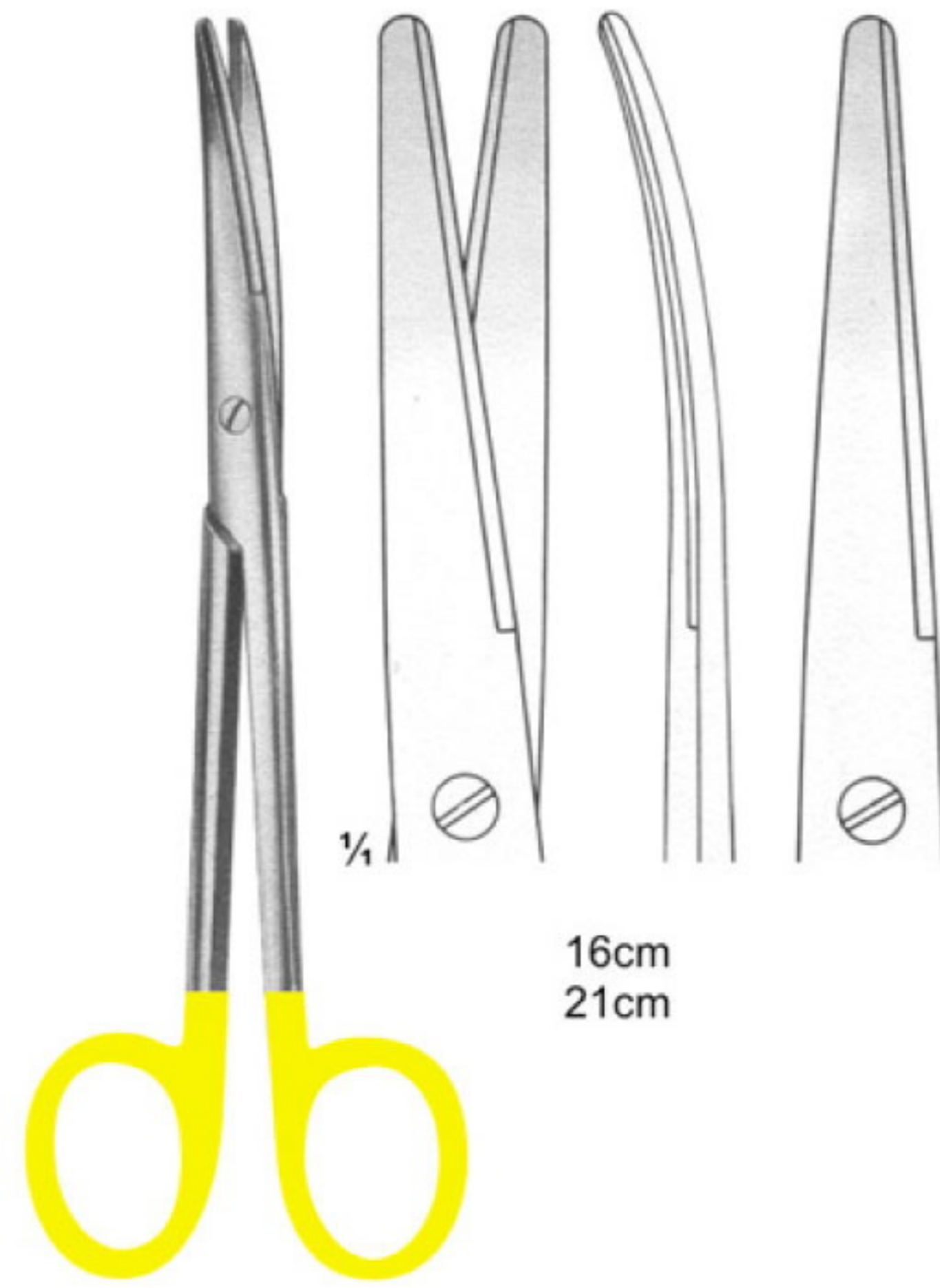

MAYO-LEXER Curved 16 cm
MWD-2810
 MAYO-LEXER Curved 16 cm

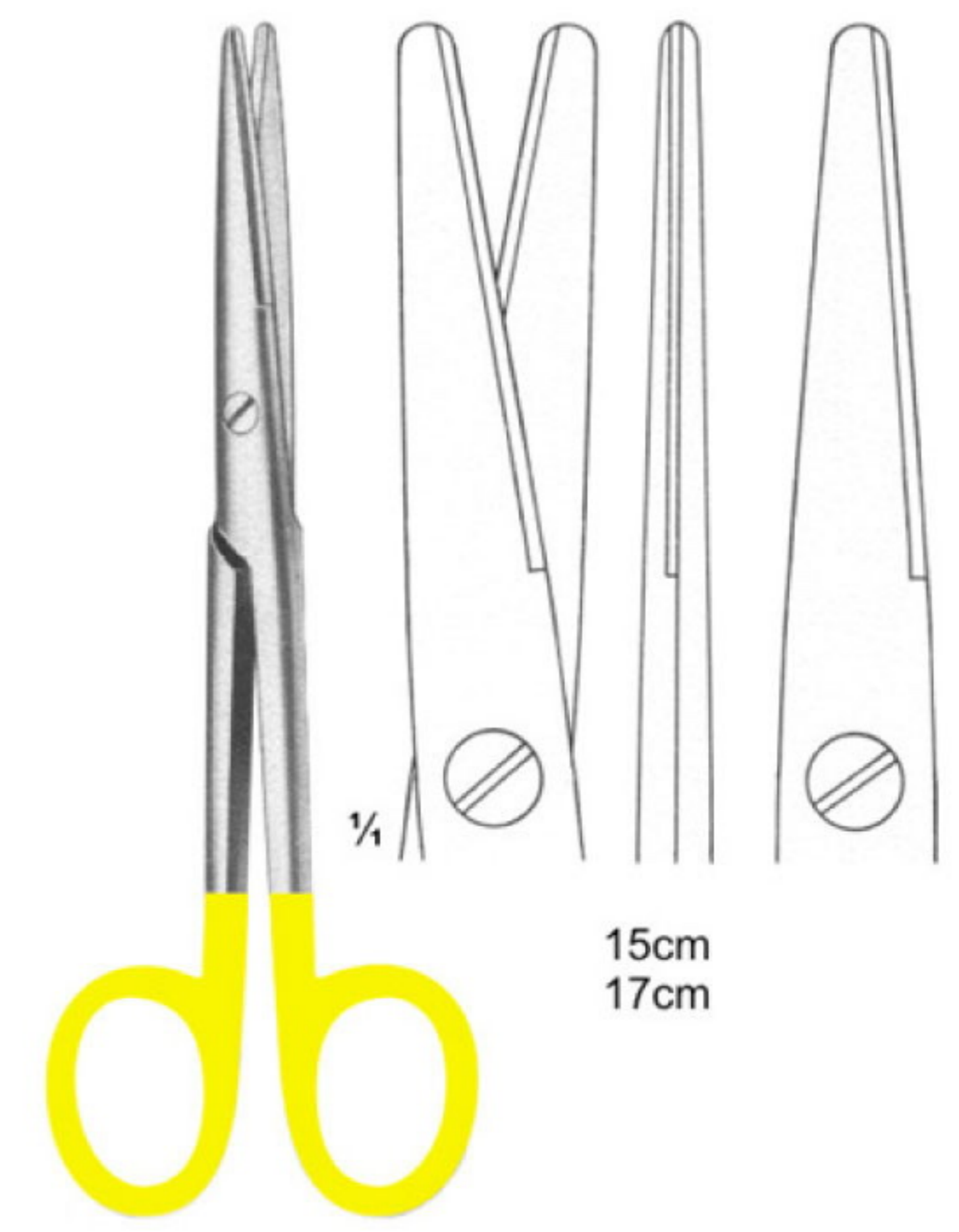

LEXER Straight 16, 21 cm
MWD-2811
 LEXER Straight 16, 21 cm

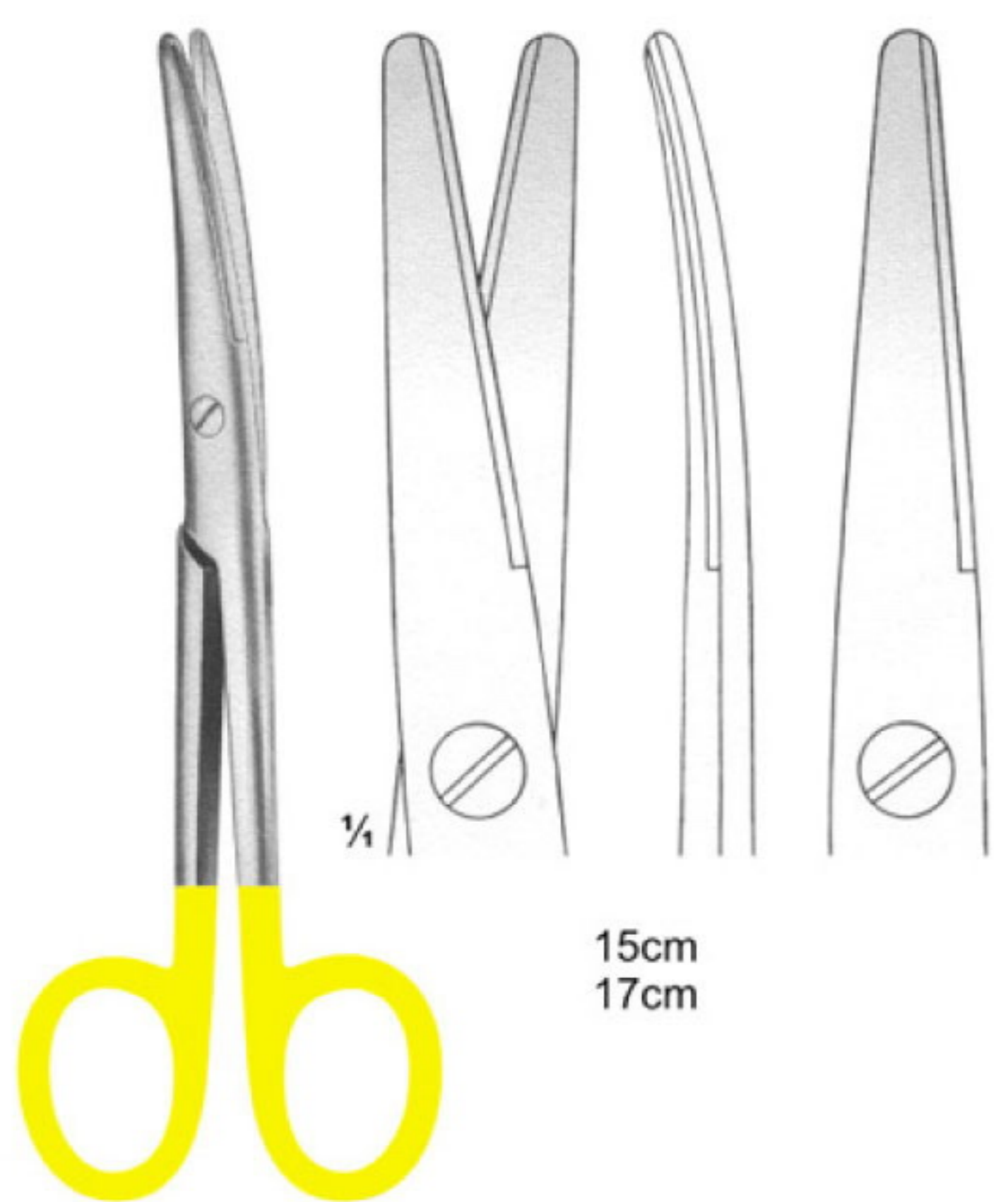

LEXER Curved 16, 21 cm
MWD-2812
 LEXER Curved 16, 21 cm

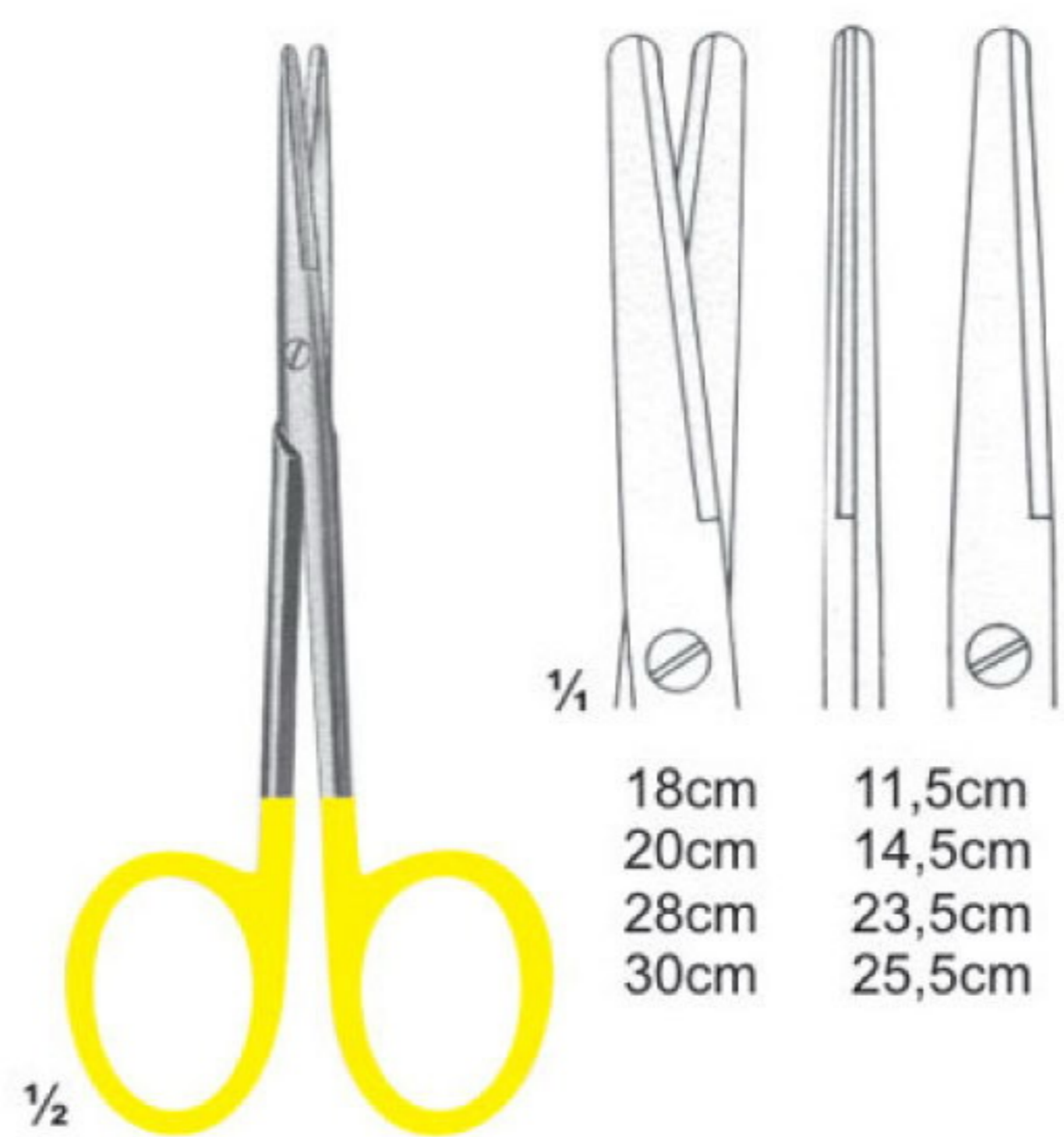

MAYO-STILLE Straight 15, 17 cm
MWD-2813
 MAYO-STILLE Straight 15, 17 cm



MAYO-STILLE Curved 15, 17 cm
MWD-2814
 MAYO-STILLE Curved 15, 17 cm

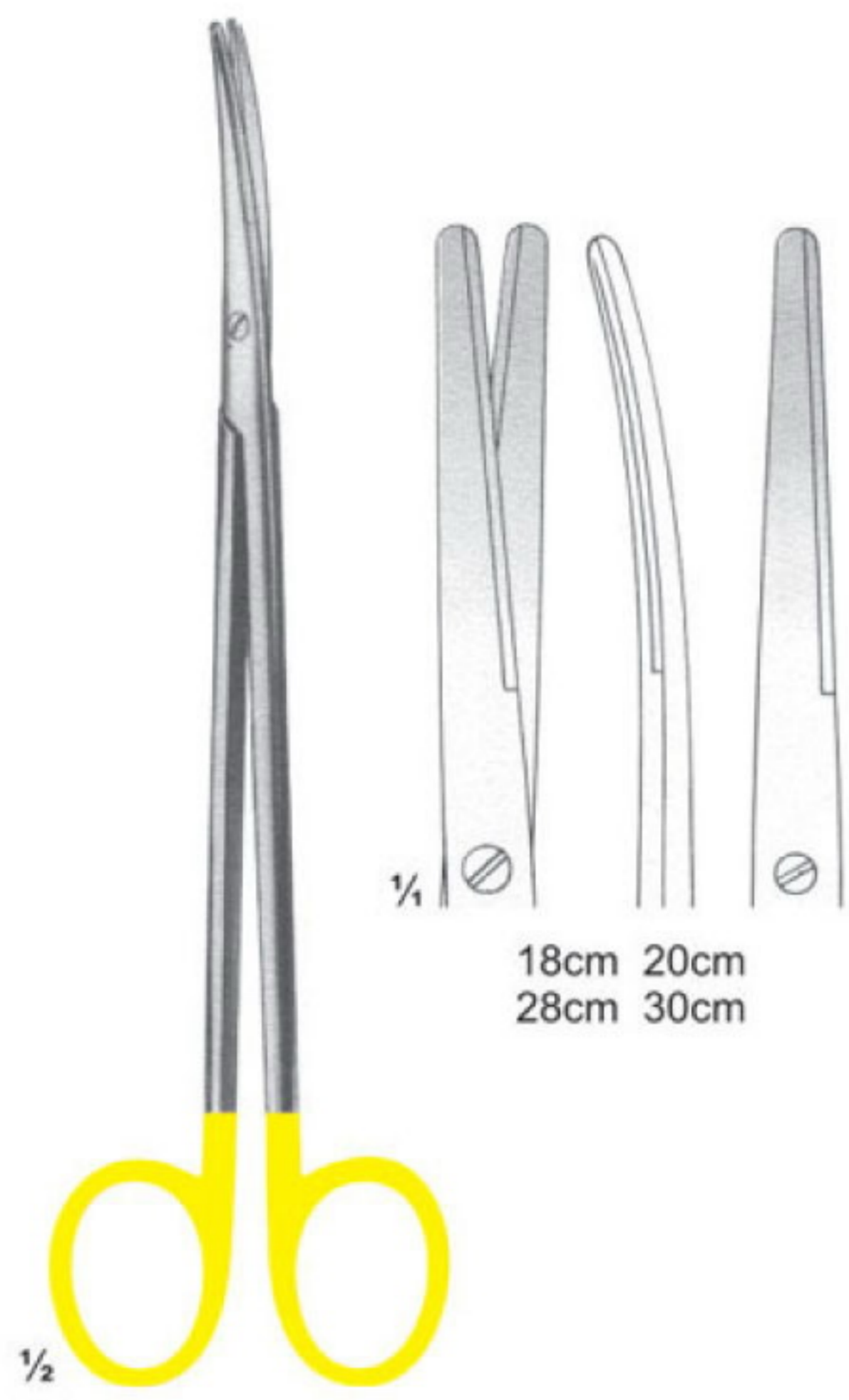

METZENBAUM Straight
MWD-2815
METZENBAUM Straight



11,5cm 14,5cm 23cm 25cm METZENBAUM Curved
MWD-2816
11,5cm 14,5cm 23cm 25cm METZENBAUM Curved



18cm 20cm 28cm 30cm METZENBAUM Curved
MWD-2817
18cm 20cm 28cm 30cm METZENBAUM Curved



14cm 18cm 20cm 23cm 25cm 28cm METZENBAUM FINO Straight
MWD-2818
14cm 18cm 20cm 23cm 25cm 28cm METZENBAUM FINO Straight



14cm 18cm 20cm 23cm METZENBAUM FINO Sharp
MWD-2820
14cm 18cm 20cm 23cm METZENBAUM FINO Sharp

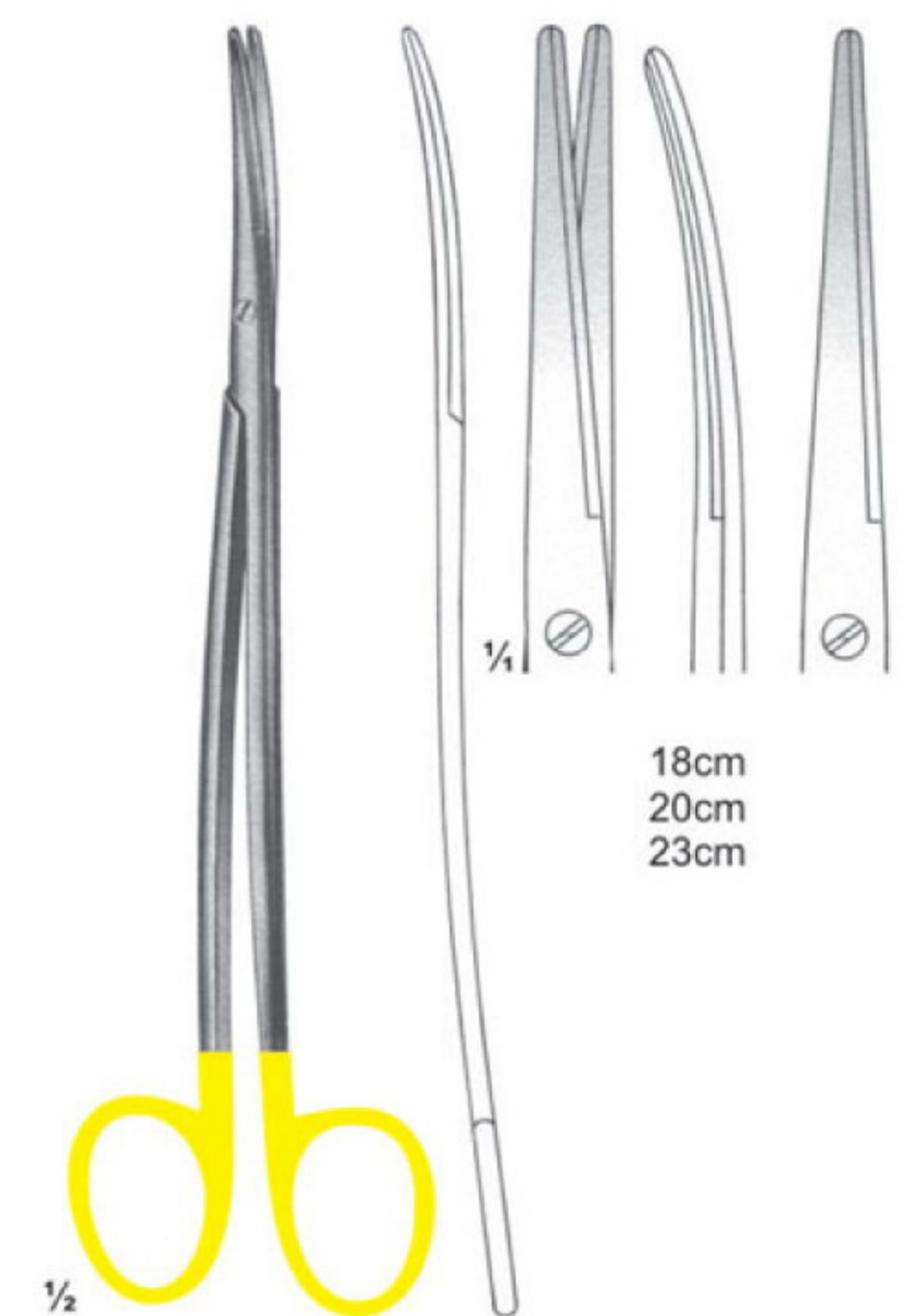

BRUNS 235 mm
MWD-2821
BRUNS 235 mm



18cm 20cm 23cm METZENBAUM FINO
MWD-2823
18cm 20cm 23cm METZENBAUM FINO

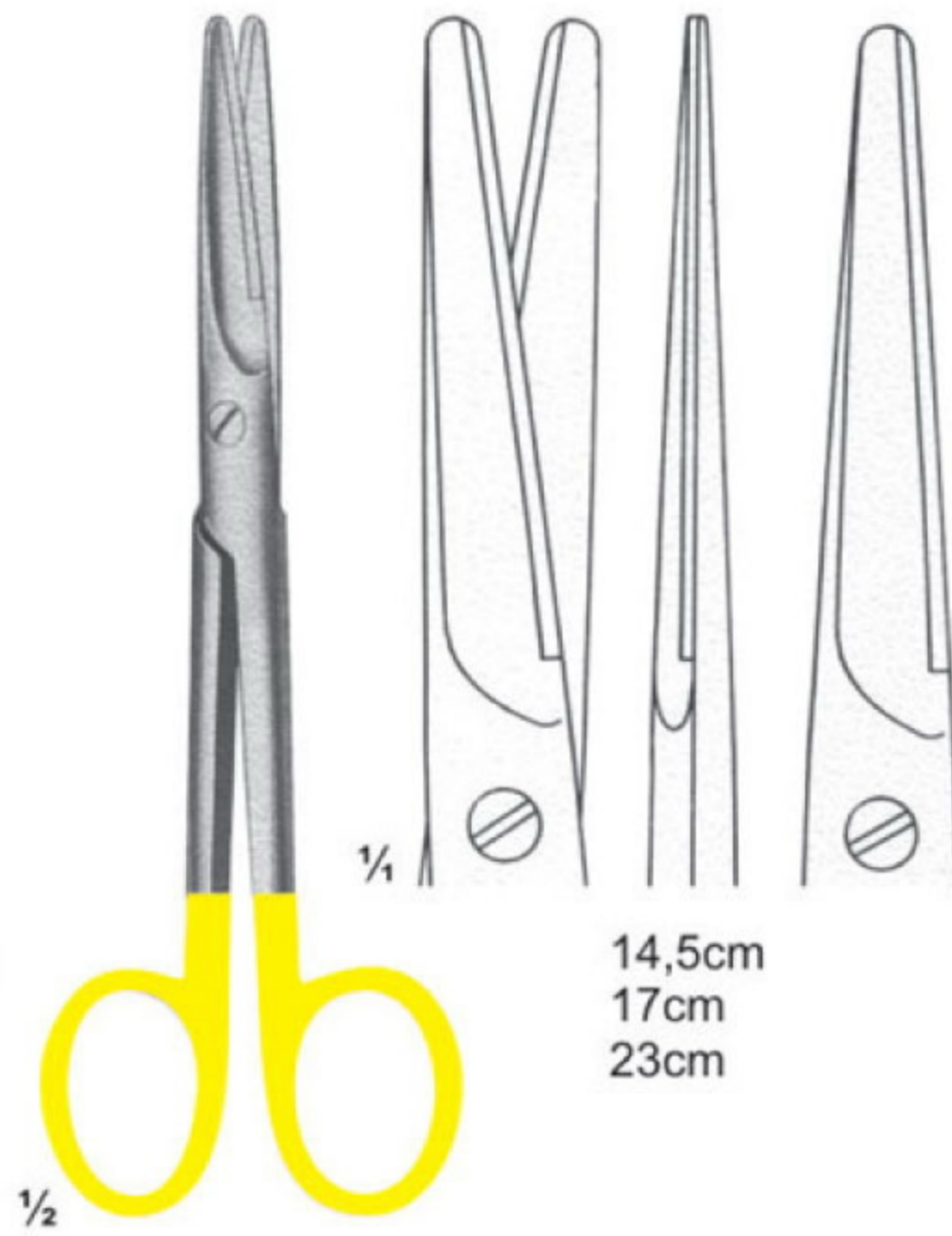

METZENBAUM FINO
MWD-2824
METZENBAUM FINO

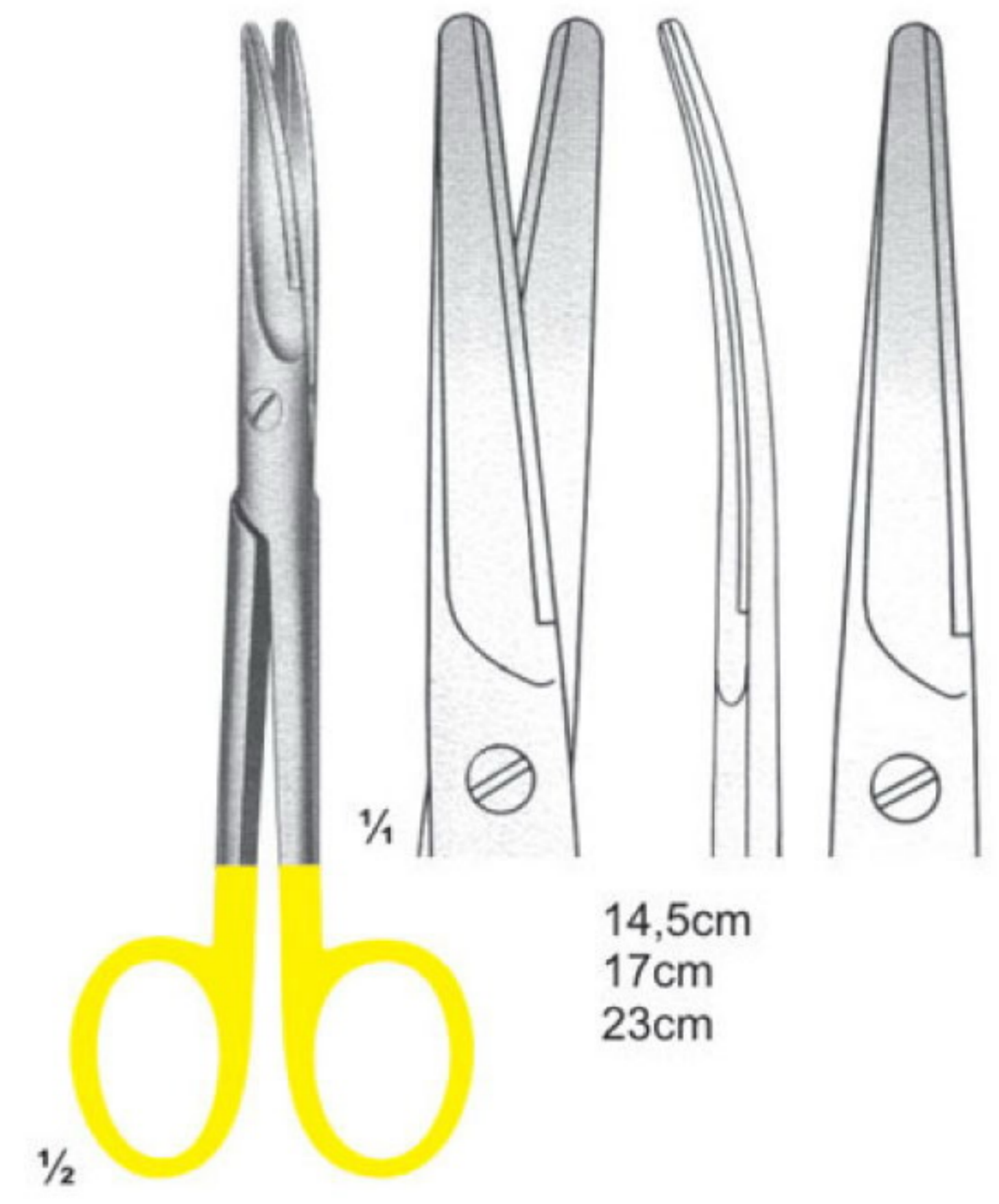

20cm 23cm METZENBAUM FINO
MWD-2825
20cm 23cm METZENBAUM FINO

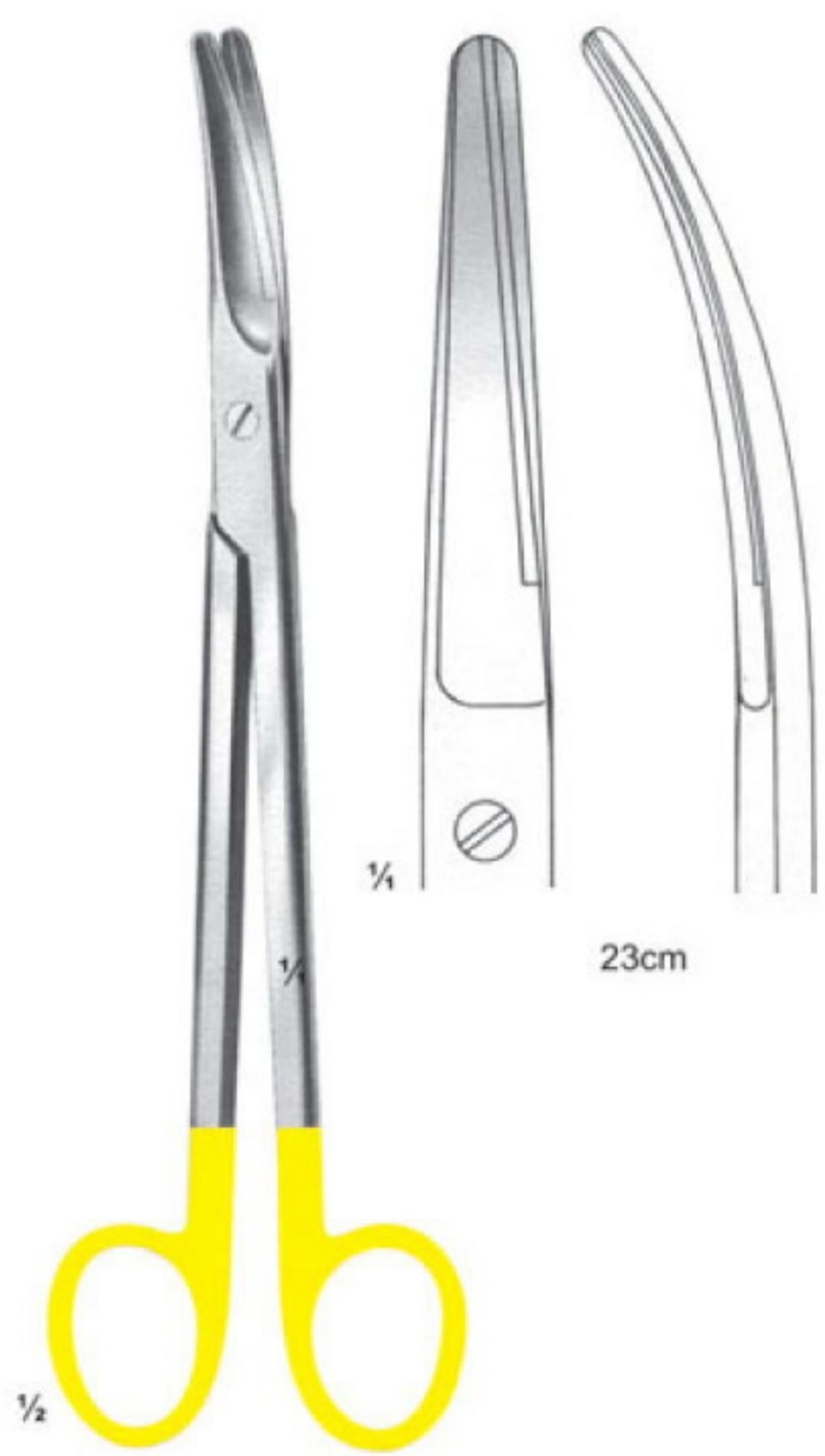

14,5cm 17cm 23cm MAYO Straight
MWD-2826
14,5cm 17cm 23cm MAYO Straight

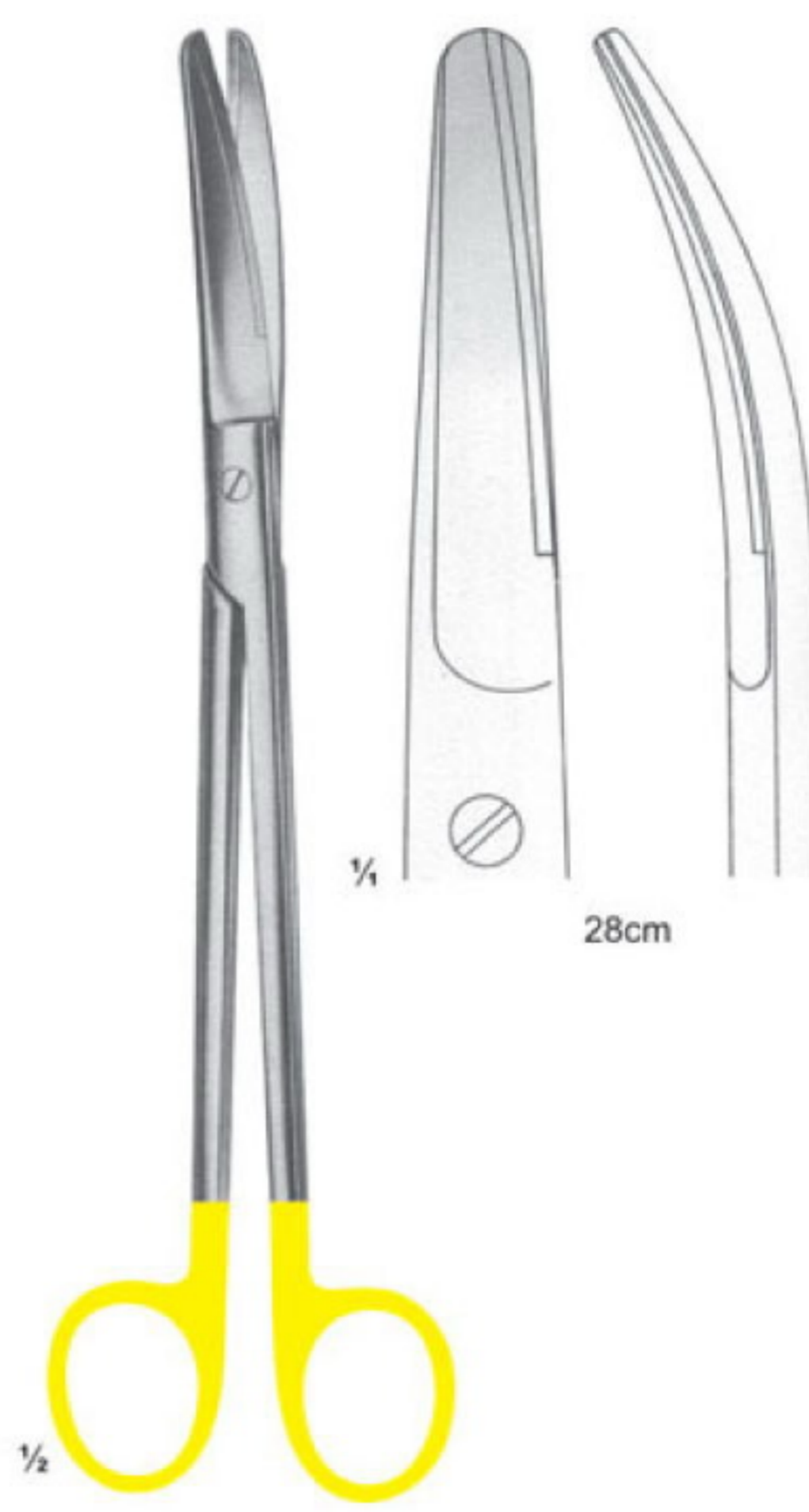

14,5cm 17cm 23cm MAYO Curved
MWD-2827
14,5cm 17cm 23cm MAYO Curved

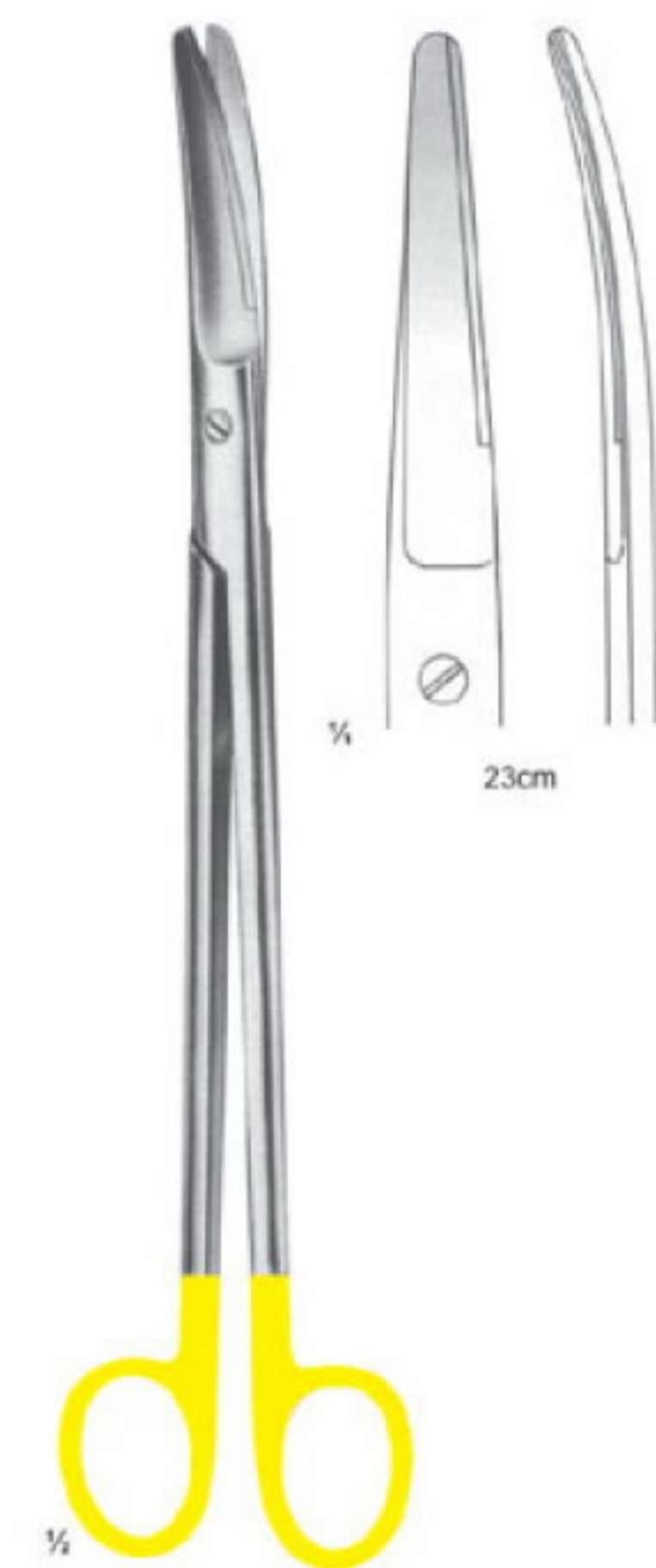

PARAMETRIUM 23cm
MWD-2828
PARAMETRIUM 23cm



MAYO-HARRINGTON
MWD-2829
MAYO-HARRINGTON



SIMS
MWD-2830
SIMS

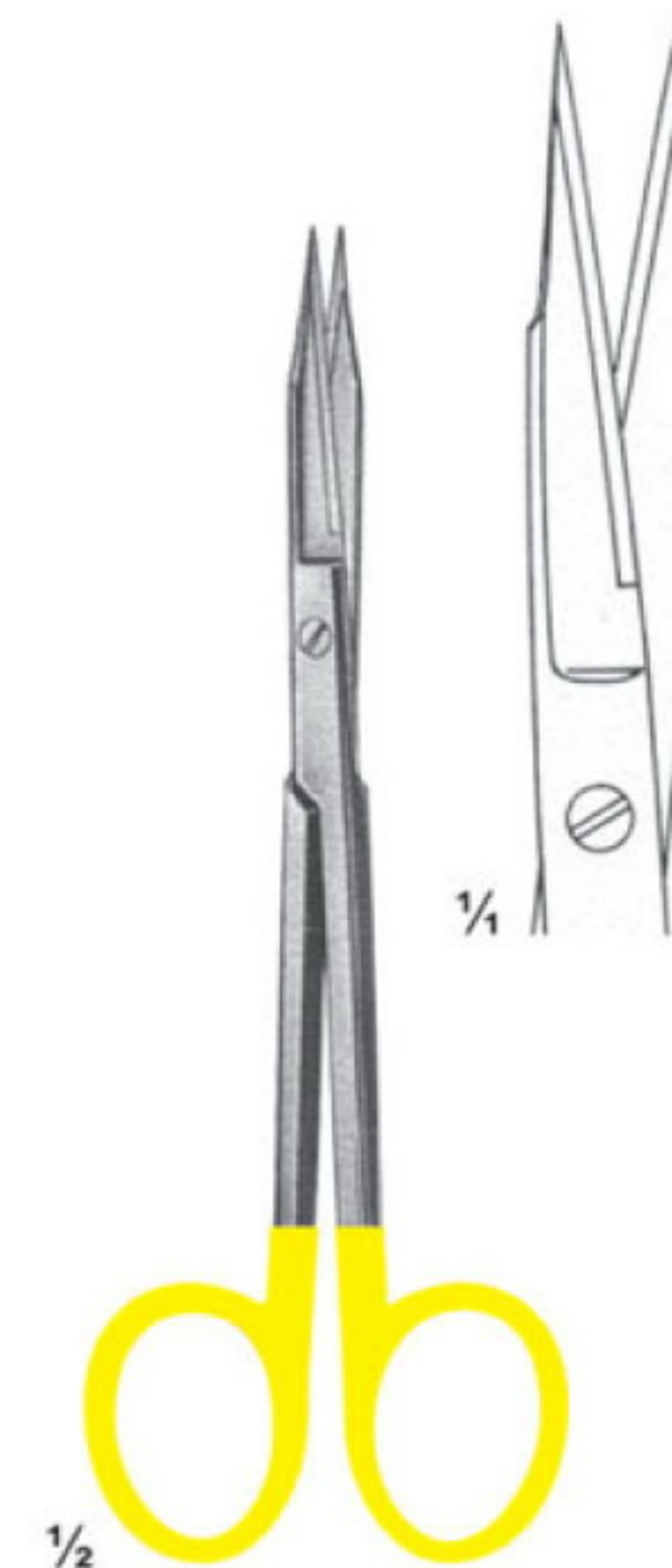

DE-BAKEY
MWD-2831
DE-BAKEY

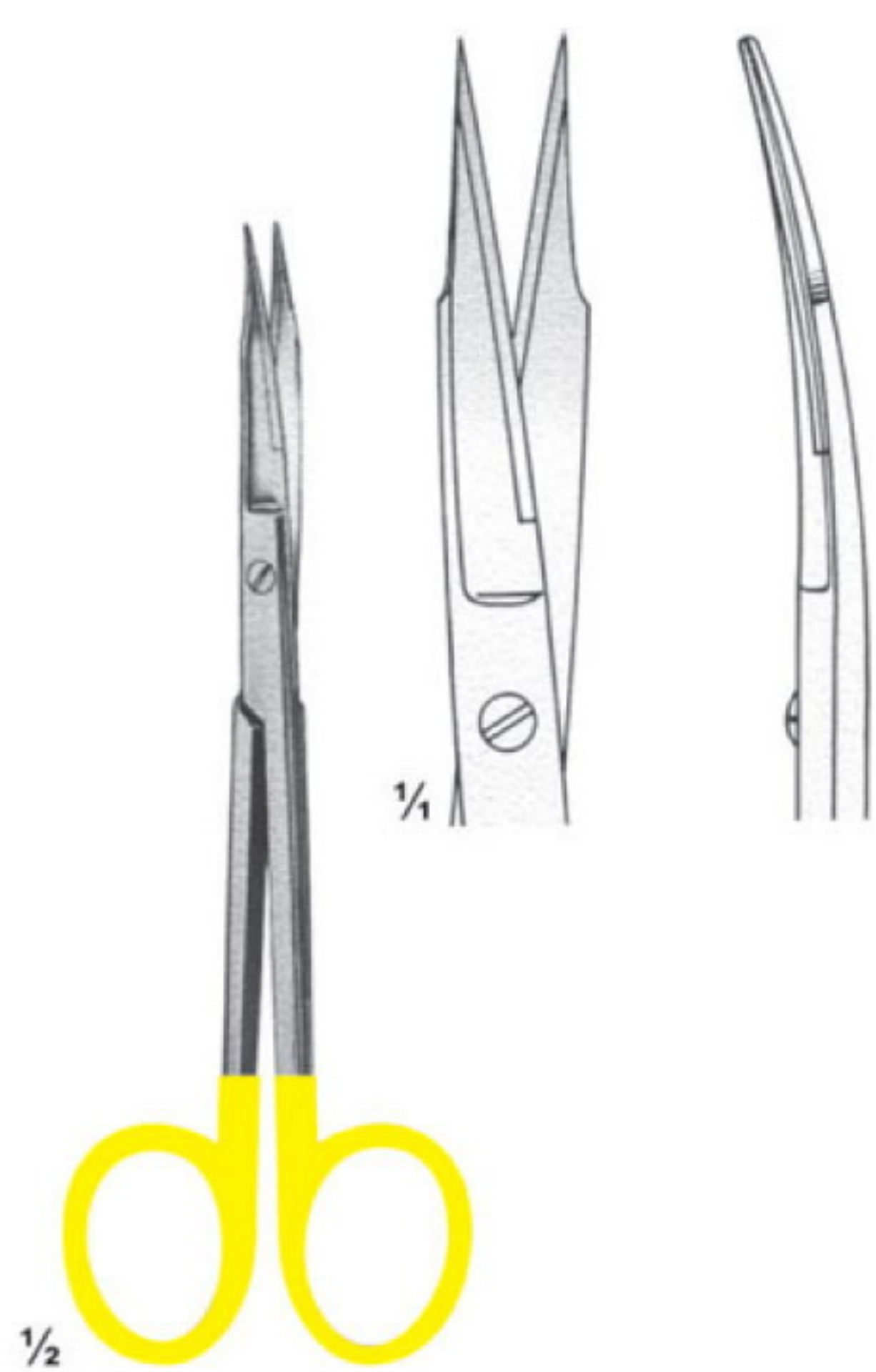

DE-BAKEY
MWD-2832
DE-BAKEY